

GET IT OFF YOUR PLATE.

TRIVANTAGE

ORDER. DONE. GOOD CALL.



®

Our job is to get you the things you need. One call to Trivantage® and it's done.

CALL 1-800-786-1876 OR VISIT TRIVANTAGE.COM

TABLE OF CONTENTS

FABRIC

AWNING	6
AWNING COMPOSER	30
UPHOLSTERY	32
MARINE	48
RECREATIONAL	68
SCREEN AND MESH	70
SHADE SAIL	89
SIGN, BANNER, MEDIA	92
SPECIAL PURPOSE	93
TENT	104
GENERAL CARE AND CLEAN	105
WARRANTY INFORMATION	106

SHADE SOLUTIONS

SOLAIR® PRO	130
SOLAIR® COMFORT	134
SOLAIR® POWER SCREEN	136
SOLAIR® CABLE & VERTICAL CURTAIN	137
SOLAIR® PATIO SCREENS	138
SOLAIR® MAXI	139
SOMFY®	140
ROLLEASE®	146

CLEAN, PROTECT, ADHERE

ADHESIVES	152
CLEANERS	154
PROTECTANTS	158

HARDWARE

AWNING	162
GROMMETS	193
FINISHING SUPPLIES FOR WEBBING	197
FASTENERS	200
MARINE	204
TENT AND TARP	240
ZIPPERS	245
TOOLS	259

TRIM AND CORD

EMBROIDERY	274
EMBELLISHMENTS	276
AWNING BRAID	278
TASSELS	279
MARINE BINDING	280
THREAD AND BOBBINS	288
WEBBING	299
ROPE AND CORDAGE	310

REFERENCE

STANDARD AWNING & MARINE STYLES	320
CALCULATIONS AND MEASUREMENTS	321
YARDAGE GUIDE AND CUTTING TABLE	324
INDEX	326
TERMS OF SALE	335
NOTES	337
CREDIT APPLICATION	

FABRIC

AWNING	6
AWNING COMPOSER	30
UPHOLSTERY	32
MARINE	48
RECREATIONAL	68
SCREEN AND MESH	70
SHADE SAIL	89
SIGN, BANNER, MEDIA	92
SPECIAL PURPOSE	93
TENT	104
GENERAL CARE AND CLEAN	105
WARRANTY INFORMATION	106



Sunbrella® Awning/Marine Solids 46 in.

A favorite for awning and marine use, Sunbrella fabric offers excellent fade and weather resistance. The fabric is water repellent, yet is also soft and easy to work with. A wide selection of colors and patterns are available to choose from, and also coordinate with Sunbrella upholstery fabrics. Sunbrella makes it easy to create beautiful designs that outperform the elements.

FABRIC	Sunbrella Acrylic
FINISH	Fluorocarbon
FR STANDARDS MET	California Technical Bulletin 117-2013 Class 1
WARRANTY	10-Year

ITEM #	STYLE #	COLOR	PUT UP	WEIGHT	WIDTH
874655	4655-0000	Alpine	65 yd.	9 oz.	46 in.
874623	4623-0000	Aquamarine	65 yd.	9 oz.	46 in.
874612	4612-0000	Aruba	65 yd.	9 oz.	46 in.
874668	4668-0000	Aspen	65 yd.	9 oz.	46 in.
874688	4688-0000	Basil	65 yd.	9 oz.	46 in.
874620	4620-0000	Beige	65 yd.	9 oz.	46 in.
874608	4608-0000	Black	65 yd.	9 oz.	46 in.
874640	4640-0000	Black Cherry	65 yd.	9 oz.	46 in.
874631	4631-0000	Burgundy	65 yd.	9 oz.	46 in.
874635	4635-0000	Buttercup	65 yd.	9 oz.	46 in.
874630	4630-0000	Cadet Grey	65 yd.	9 oz.	46 in.
874675	4675-0000	Capri	65 yd.	9 oz.	46 in.
874646	4646-0000	Captain Navy	65 yd.	9 oz.	46 in.
874644	4644-0000	Charcoal Grey	65 yd.	9 oz.	46 in.
874607	4607-0000	Charcoal Tweed	65 yd.	9 oz.	46 in.
874676	4676-0000	Cocoa	65 yd.	9 oz.	46 in.
874665	4665-0000	Concord	65 yd.	9 oz.	46 in.
874662	4662-0000	Crest Ash	65 yd.	9 oz.	46 in.
874660	4660-0000	Crest Birch	65 yd.	9 oz.	46 in.
874561	4661-0000	Crest Denim	65 yd.	9 oz.	46 in.
874606	4606-0000	Dubonnet Tweed	65 yd.	9 oz.	46 in.
874600	4600-0000	Erin Green	65 yd.	9 oz.	46 in.
874671	4671-0000	Fern	65 yd.	9 oz.	46 in.
874637	4637-0000	Forest Green	65 yd.	9 oz.	46 in.
874685	4685-0000	Ginkgo	65 yd.	9 oz.	46 in.
874672	4672-0000	Heather Beige	65 yd.	9 oz.	46 in.
874605	4605-0000	Hemlock Tweed	65 yd.	9 oz.	46 in.
874663	4663-0000	Hyacinth	65 yd.	9 oz.	46 in.
874532	4632-0000	Ivy	65 yd.	9 oz.	46 in.
874603	4603-0000	Jockey Red	65 yd.	9 oz.	46 in.
874633	4633-0000	Linen	65 yd.	9 oz.	46 in.
874654	4654-0000	Linen Tweed	65 yd.	9 oz.	46 in.
874666	4666-0000	Logo Red	65 yd.	9 oz.	46 in.
874667	4667-0000	Mahogany	65 yd.	9 oz.	46 in.
874678	4678-0000	Marine Blue	65 yd.	9 oz.	46 in.
874652	4652-0000	Mediterranean Blue	65 yd.	9 oz.	46 in.
874653	4653-0000	Mediterranean Blue Tweed	65 yd.	9 oz.	46 in.
875701	4701-0000	Mix Emerald	65 yd.	9 oz.	46 in.
875700	4700-0000	Mix Redwood	65 yd.	9 oz.	46 in.
874616	4616-0000	Mocha Tweed	65 yd.	9 oz.	46 in.

ITEM #	STYLE #	COLOR	PUT UP	WEIGHT	WIDTH
874604	4604-0000	Natural	65 yd.	9 oz.	46 in.
874626	4626-0000	Navy	65 yd.	9 oz.	46 in.
874686	4686-0000	Nutmeg	65 yd.	9 oz.	46 in.
874679	4679-0000	Ocean Blue	65 yd.	9 oz.	46 in.
874609	4609-0000	Orange	65 yd.	9 oz.	46 in.
874642	4642-0000	Oyster	65 yd.	9 oz.	46 in.
874601	4601-0000	Pacific Blue	65 yd.	9 oz.	46 in.
874683	4683-0000	Parchment	65 yd.	9 oz.	46 in.
874643	4643-0000	Persian Green	65 yd.	9 oz.	46 in.
874617	4617-0000	Royal Blue Tweed	65 yd.	9 oz.	46 in.
874689	4689-0000	Rust	65 yd.	9 oz.	46 in.
874641	4641-0000	Sapphire Blue	65 yd.	9 oz.	46 in.
874664	4664-0000	Sea	65 yd.	9 oz.	46 in.
874645	4645-0000	Seagrass Green	65 yd.	9 oz.	46 in.
874858	4858-0000	Silica Barley	65 yd.	9 oz.	46 in.
874897	4897-0000	Silica Charcoal	65 yd.	9 oz.	46 in.
874859	4859-0000	Silica Dune	65 yd.	9 oz.	46 in.
874896	4896-0000	Silica Sage	65 yd.	9 oz.	46 in.
874860	4860-0000	Silica Sesame	65 yd.	9 oz.	46 in.
874862	4862-0000	Silica Silver	65 yd.	9 oz.	46 in.
874861	4861-0000	Silica Stone	65 yd.	9 oz.	46 in.
874651	4651-0000	Silver	65 yd.	9 oz.	46 in.
874624	4624-0000	Sky Blue	65 yd.	9 oz.	46 in.
874684	4684-0000	Slate	65 yd.	9 oz.	46 in.
874615	4615-0000	Smoke	65 yd.	9 oz.	46 in.
874673	4673-0000	Spa	65 yd.	9 oz.	46 in.
874602	4602-0000	Sunflower Yellow	65 yd.	9 oz.	46 in.
874614	4614-0000	Tan	65 yd.	9 oz.	46 in.
874648	4648-0000	Taupe	65 yd.	9 oz.	46 in.
874622	4622-0000	Terracotta	65 yd.	9 oz.	46 in.
874628	4628-0000	Toast	65 yd.	9 oz.	46 in.
874696	4696-0000	Tresco Birch	65 yd.	9 oz.	46 in.
874658	4658-0000	Tresco Brass	65 yd.	9 oz.	46 in.
874699	4699-0000	Tresco Brick	65 yd.	9 oz.	46 in.
874698	4698-0000	Tresco Clay	65 yd.	9 oz.	46 in.
874697	4697-0000	Tresco Ginger	65 yd.	9 oz.	46 in.
874695	4695-0000	Tresco Linen	65 yd.	9 oz.	46 in.
874621	4621-0000	True Brown	65 yd.	9 oz.	46 in.
874610	4610-0000	Turquoise	65 yd.	9 oz.	46 in.
874677	4677-0000	Tuscan	65 yd.	9 oz.	46 in.
874618	4618-0000	Walnut Brown Tweed	65 yd.	9 oz.	46 in.
874674	4674-0000	Wheat	65 yd.	9 oz.	46 in.

Sunbrella® is a registered trademark of Glen Raven, Inc.



Sunbrella® Awning/Marine Solids 60 in.

A favorite for awning and marine use, Sunbrella fabric offers excellent fade and weather resistance. The fabric is water repellent, yet is also soft and easy to work with. A wide selection of colors and patterns are available to choose from, and also coordinate with Sunbrella upholstery fabrics. Sunbrella makes it easy to create beautiful designs that outperform the elements.

FABRIC	Sunbrella Acrylic
FINISH	Fluorocarbon
FR STANDARDS MET	California Technical Bulletin 117-2013 Class 1
WARRANTY	10-Year

ITEM #	STYLE #	COLOR	PUT UP	WEIGHT	WIDTH
721789	6055-0000	Alpine	65 yd.	9 oz.	60 in.
721760	6023-0000	Aquamarine	65 yd.	9 oz.	60 in.
721766	6012-0000	Aruba	65 yd.	9 oz.	60 in.
721802	6068-0000	Aspen	65 yd.	9 oz.	60 in.
721824	6088-0000	Basil	65 yd.	9 oz.	60 in.

ITEM #	STYLE #	COLOR	PUT UP	WEIGHT	WIDTH
721790	6020-0000	Beige	65 yd.	9 oz.	60 in.
721755	6008-0000	Black	65 yd.	9 oz.	60 in.
721774	6040-0000	Black Cherry	65 yd.	9 oz.	60 in.
721765	6031-0000	Burgundy	65 yd.	9 oz.	60 in.
721770	6035-0000	Buttercup	65 yd.	9 oz.	60 in.
721764	6030-0000	Cadet Grey	65 yd.	9 oz.	60 in.
721809	6075-0000	Capri	65 yd.	9 oz.	60 in.
721780	6046-0000	Captain Navy	65 yd.	9 oz.	60 in.
721778	6044-0000	Charcoal Grey	65 yd.	9 oz.	60 in.
721747	6007-0000	Charcoal Tweed	65 yd.	9 oz.	60 in.
721810	6076-0000	Cocoa	65 yd.	9 oz.	60 in.
721799	6065-0000	Concord	65 yd.	9 oz.	60 in.
721754	6006-0000	Dubonnet Tweed	65 yd.	9 oz.	60 in.
721745	6000-0000	Erin Green	65 yd.	9 oz.	60 in.
721805	6071-0000	Fern	65 yd.	9 oz.	60 in.
721771	6037-0000	Forest Green	65 yd.	9 oz.	60 in.
721821	6085-0000	Ginkgo	65 yd.	9 oz.	60 in.
721806	6072-0000	Heather Beige	65 yd.	9 oz.	60 in.
721753	6005-0000	Hemlock Tweed	65 yd.	9 oz.	60 in.
721832	6032-0000	Ivy	65 yd.	9 oz.	60 in.
721751	6003-0000	Jockey Red	65 yd.	9 oz.	60 in.
721767	6033-0000	Linen	65 yd.	9 oz.	60 in.
721788	6054-0000	Linen Tweed	65 yd.	9 oz.	60 in.
721800	6066-0000	Logo Red	65 yd.	9 oz.	60 in.
721801	6067-0000	Mahogany	65 yd.	9 oz.	60 in.
721812	6078-0000	Marine Blue	65 yd.	9 oz.	60 in.
721786	6052-0000	Mediterranean Blue	65 yd.	9 oz.	60 in.
721787	6053-0000	Mediterranean Blue Tweed	65 yd.	9 oz.	60 in.
721743	6016-0000	Mocha Tweed	65 yd.	9 oz.	60 in.
721752	6004-0000	Natural	65 yd.	9 oz.	60 in.
721762	6026-0000	Navy	65 yd.	9 oz.	60 in.
721822	6086-0000	Nutmeg	65 yd.	9 oz.	60 in.
721813	6079-0000	Ocean Blue	65 yd.	9 oz.	60 in.
721741	6009-0000	Orange	65 yd.	9 oz.	60 in.
721776	6042-0000	Oyster	65 yd.	9 oz.	60 in.
721750	6001-0000	Pacific Blue	65 yd.	9 oz.	60 in.
721817	6083-0000	Parchment	65 yd.	9 oz.	60 in.
721777	6043-0000	Persian Green	65 yd.	9 oz.	60 in.
721757	6017-0000	Royal Blue Tweed	65 yd.	9 oz.	60 in.
721739	2079-0060	Royal Navy	65 yd.	9 oz.	60 in.
721825	6089-0000	Rust	65 yd.	9 oz.	60 in.
721768	6027-0000	Salmon	65 yd.	9 oz.	60 in.
721775	6041-0000	Sapphire Blue	65 yd.	9 oz.	60 in.
721779	6045-0000	Seagrass Green	65 yd.	9 oz.	60 in.
721785	6051-0000	Silver	65 yd.	9 oz.	60 in.
721761	6024-0000	Sky Blue	65 yd.	9 oz.	60 in.
721818	6084-0000	Slate	65 yd.	9 oz.	60 in.
721815	6015-0000	Smoke	65 yd.	9 oz.	60 in.
721807	6073-0000	Spa	65 yd.	9 oz.	60 in.
721746	6002-0000	Sunflower Yellow	65 yd.	9 oz.	60 in.
721742	6014-0000	Tan	65 yd.	9 oz.	60 in.

ITEM #	STYLE #	COLOR	PUT UP	WEIGHT	WIDTH
721782	6048-0000	Taupe	65 yd.	9 oz.	60 in.
721784	6050-0000	Teal Tweed	65 yd.	9 oz.	60 in.
721744	6022-0000	Terracotta	65 yd.	9 oz.	60 in.
721763	6028-0000	Toast	65 yd.	9 oz.	60 in.
721872	2389-0060	Toast Tweed	65 yd.	9 oz.	60 in.
721827	6096-0000	Tresco Birch	65 yd.	9 oz.	60 in.
721795	6058-0000	Tresco Brass	65 yd.	9 oz.	60 in.
721830	6099-0000	Tresco Brick	65 yd.	9 oz.	60 in.
721829	6098-0000	Tresco Clay	65 yd.	9 oz.	60 in.
721828	6097-0000	Tresco Ginger	65 yd.	9 oz.	60 in.
721814	6094-0000	Tresco Indigo	65 yd.	9 oz.	60 in.
721826	6095-0000	Tresco Linen	65 yd.	9 oz.	60 in.
721759	6021-0000	True Brown	65 yd.	9 oz.	60 in.
721748	6010-0000	Turquoise	65 yd.	9 oz.	60 in.
721811	6077-0000	Tuscan	65 yd.	9 oz.	60 in.
721758	6018-0000	Walnut Brown Tweed	65 yd.	9 oz.	60 in.
721808	6074-0000	Wheat	65 yd.	9 oz.	60 in.

Sunbrella® is a registered trademark of Glen Raven, Inc.

Sunbrella® Awning/Marine Solids 80 in.

A favorite for awning and marine use, Sunbrella fabric offers excellent fade and weather resistance. The fabric is water repellent, yet is also soft and easy to work with. A wide selection of colors and patterns are available to choose from, and also coordinate with Sunbrella upholstery fabrics. Sunbrella makes it easy to create beautiful designs that outperform the elements.

FABRIC	Sunbrella Acrylic
FINISH	Fluorocarbon
FR STANDARDS MET	California Technical Bulletin 117-2013 Class 1
WARRANTY	10-Year

ITEM #	STYLE #	COLOR	PUT UP	WEIGHT	WIDTH
722308	80008-0000	Black	50 yd.	9 oz.	80 in.
722331	80031-0000	Burgundy	50 yd.	9 oz.	80 in.
722330	80030-0000	Cadet Grey	50 yd.	9 oz.	80 in.
722346	80046-0000	Captain Navy	50 yd.	9 oz.	80 in.
722337	80037-0000	Forest Green	50 yd.	9 oz.	80 in.
722301	80001-0000	Pacific Blue	50 yd.	9 oz.	80 in.
722328	80028-0000	Toast	50 yd.	9 oz.	80 in.

Sunbrella® is a registered trademark of Glen Raven, Inc.



Sunbrella® Awning Stripes

Awning made with Sunbrella fabric provide protection from the elements and extend your living space. Stylish awning stripes make a statement, and coordinate beautifully with other Sunbrella fabrics.

FABRIC	Sunbrella Acrylic
FINISH	Fluorocarbon
FR STANDARDS MET	California Technical Bulletin 117-2013 Class 1
WARRANTY	10-Year

ITEM #	STYLE #	COLOR	PUT UP	WEIGHT	WIDTH
874995	4995-0000	Ashford Forest	65 yd.	9 oz.	46 in.
874830	4830-0000	Balance Ember	65 yd.	9 oz.	46 in.
874829	4829-0000	Balance Tidepool	65 yd.	9 oz.	46 in.
874993	4993-0000	Baycrest Pacific	65 yd.	9 oz.	46 in.
874992	4992-0000	Baycrest Sky	65 yd.	9 oz.	46 in.
874704	5704-0000	Beaufort Black/White 6 Bar	65 yd.	9 oz.	46 in.
874806	4806-0000	Beaufort Forest Green/Natural 6 Bar	65 yd.	9 oz.	46 in.
874702	5702-0000	Beaufort Yellow/White 6 Bar	65 yd.	9 oz.	46 in.

ITEM #	STYLE #	COLOR	PUT UP	WEIGHT	WIDTH
874796	4796-0000	Beige/White	65 yd.	9 oz.	46 in.
874773	4773-0000	Bisque Brown	65 yd.	9 oz.	46 in.
874923	4923-0000	Black Forest Fancy	65 yd.	9 oz.	46 in.
874946	4946-0000	Black/Taupe Fancy	65 yd.	9 oz.	46 in.
874755	4755-0000	Blue Fancy	65 yd.	9 oz.	46 in.
874939	4939-0000	Brass/Black Cherry Classic	65 yd.	9 oz.	46 in.
874798	4798-0000	Burgundy/Black/White	65 yd.	9 oz.	46 in.
874902	4902-0000	Captain Navy/NT Classic	65 yd.	9 oz.	46 in.
874776	4776-0000	Chocolate Chip Fancy	65 yd.	9 oz.	46 in.
874888	4888-0000	Clinton Granite	65 yd.	9 oz.	46 in.
874855	4855-0000	Colonnade Fossil	65 yd.	9 oz.	46 in.
874856	4856-0000	Colonnade Juniper	65 yd.	9 oz.	46 in.
874857	4857-0000	Colonnade Redwood	65 yd.	9 oz.	46 in.
874988	4988-0000	Cooper Black	65 yd.	9 oz.	46 in.
874987	4987-0000	Cooper Navy	65 yd.	9 oz.	46 in.
874889	4889-0000	Courtland Pebble	65 yd.	9 oz.	46 in.
874813	4813-0000	Eastland Redwood	65 yd.	9 oz.	46 in.
874994	4994-0000	Eastridge Cocoa	65 yd.	9 oz.	46 in.
874766	4766-0000	Era Ash	65 yd.	9 oz.	46 in.
874762	4762-0000	Era Cornsilk	65 yd.	9 oz.	46 in.
874763	4763-0000	Era Indigo	65 yd.	9 oz.	46 in.
874764	4764-0000	Era Mist	65 yd.	9 oz.	46 in.
874955	4955-0000	Fern Classic	65 yd.	9 oz.	46 in.
874959	4959-0000	Fern/Heather Beige Blockstripe	65 yd.	9 oz.	46 in.
874790	4790-0000	Forest Green Fancy	65 yd.	9 oz.	46 in.
874949	4949-0000	Forest Vintage Bar Stripe	65 yd.	9 oz.	46 in.
874932	4932-0000	Forest/Beige/Natural/Sage Fancy	65 yd.	9 oz.	46 in.
874777	4777-0000	Grey/Beige Chip Fancy	65 yd.	9 oz.	46 in.
874799	4799-0000	Grey/Black/White	65 yd.	9 oz.	46 in.
874989	4989-0000	Hatteras Raven	65 yd.	9 oz.	46 in.
874985	4985-0000	Havelock Brick	65 yd.	9 oz.	46 in.
874954	4954-0000	Heather Beige Classic	65 yd.	9 oz.	46 in.
874751	4751-0000	Hemlock Tweed Fancy	65 yd.	9 oz.	46 in.
874969	4969-0000	Henna/Fern Vintage	65 yd.	9 oz.	46 in.
874934	4934-0000	Intrigue Neon	65 yd.	9 oz.	46 in.
874868	4868-0000	Kiawah Spa	65 yd.	9 oz.	46 in.
874789	4789-0000	Manhattan Classic	65 yd.	9 oz.	46 in.
874891	4891-0000	Manhattan Dune	65 yd.	9 oz.	46 in.
874876	4876-0000	Manhattan Fog	65 yd.	9 oz.	46 in.
874991	4991-0000	Manteo Cardinal	65 yd.	9 oz.	46 in.
874921	4921-0000	Mediterranean/Canvas Block Stripe	65 yd.	9 oz.	46 in.
874895	4895-0000	Motive Denim	65 yd.	9 oz.	46 in.
874894	4894-0000	Motive Dusk	65 yd.	9 oz.	46 in.
874916	4916-0000	Navy/Taupe Fancy	65 yd.	9 oz.	46 in.
874909	4909-0000	Plum Fancy	65 yd.	9 oz.	46 in.
874767	4767-0000	Preston Radiance	65 yd.	9 oz.	46 in.
874768	4768-0000	Preston Stone	65 yd.	9 oz.	46 in.
874770	4770-0000	Providence Americana	65 yd.	9 oz.	46 in.
874961	4961-0000	Putty Regimental	65 yd.	9 oz.	46 in.
874879	4879-0000	Rodanthe Metallic	65 yd.	9 oz.	46 in.

ITEM #	STYLE #	COLOR	PUT UP	WEIGHT	WIDTH
874878	4878-0000	Rodanthe Sunrise	65 yd.	9 oz.	46 in.
874948	4948-0000	Sapphire Vintage	65 yd.	9 oz.	46 in.
874884	4884-0000	Saxon Cascade	65 yd.	9 oz.	46 in.
874885	4885-0000	Saxon Chili	65 yd.	9 oz.	46 in.
874901	4901-0000	Sunbrella Navy/Green/Yellow/ Red Regimental	65 yd.	9 oz.	46 in.
874907	4907-0000	Taupe 5-Bar	65 yd.	9 oz.	46 in.
874945	4945-0000	Taupe Tailored Bar	65 yd.	9 oz.	46 in.
874817	4817-0000	Westfield Mushroom	65 yd.	9 oz.	46 in.

Sunbrella® is a registered trademark of Glen Raven, Inc.



ITEM #	STYLE #	COLOR	PUT UP	WEIGHT	WIDTH
874982	4982-0000	Beaufort/Classic	65 yd.	9 oz.	46 in.
874760	5760-0000	Beige/White 6-Bar (Beaufort)	65 yd.	9 oz.	46 in.
874962	4962-0000	Captain Navy Regimental	65 yd.	9 oz.	46 in.
874833	4756-0000	Cavalier Colonial	65 yd.	9 oz.	46 in.
874834	4758-0000	Cavalier Raven	65 yd.	9 oz.	46 in.
874854	4854-0000	Coastal/Herbal	65 yd.	9 oz.	46 in.
874851	4851-0000	Coastal/Spa	65 yd.	9 oz.	46 in.
874818	4818-0000	Cordell Redwood	65 yd.	9 oz.	46 in.
874836	4760-0000	Crestview Mushroom	65 yd.	9 oz.	46 in.
874835	4759-0000	Crestview Oak	65 yd.	9 oz.	46 in.
874837	4761-0000	Crestview Seaglass	65 yd.	9 oz.	46 in.
874691	4691-0000	Deep Sea	65 yd.	9 oz.	46 in.
874960	4960-0000	Fern Graduated Stripe	65 yd.	9 oz.	46 in.
874963	4963-0000	Forest Green Regimental	65 yd.	9 oz.	46 in.
874828	4828-0000	Granville Mahogany	65 yd.	9 oz.	46 in.
874827	4827-0000	Granville Paprika	65 yd.	9 oz.	46 in.
874826	4826-0000	Granville Tinsel	65 yd.	9 oz.	46 in.
874754	4754-0000	Green Fancy	65 yd.	9 oz.	46 in.
874973	4973-0000	Hartwell/Fiesta	65 yd.	9 oz.	46 in.
874705	4705-0000	Hemlock Tweed Formal	65 yd.	9 oz.	46 in.
874971	4971-0000	Lankford/Woodland	65 yd.	9 oz.	46 in.
874881	4881-0000	Moreland Chestnut	65 yd.	9 oz.	46 in.
874880	4880-0000	Moreland Taupe	65 yd.	9 oz.	46 in.
874692	4692-0000	Palm	65 yd.	9 oz.	46 in.
874693	4693-0000	Pink	65 yd.	9 oz.	46 in.

Sunbrella® and Trivantage® are registered trademarks of Glen Raven, Inc.

Sunbrella® Mayfield Collection

Available exclusively from Trivantage®, the Mayfield Collection of Sunbrella awning fabrics is a beautiful collection of sophisticated patterns and colors combining a premium aesthetic with Sunbrella’s legendary performance and durability. Classic designs in refined colors and wider repeats add style and elegance to any awning or canopy.

Coordinating awning fabrics with furniture is an effective way to elevate the appeal of shaded outdoor living spaces. Mayfield is designed to work with Sunbrella upholstery fabrics, including the Sunbrella Fusion collection, also available exclusively through Trivantage.

FABRIC	Sunbrella Acrylic
FINISH	Fluorocarbon
FR STANDARDS MET	California Technical Bulletin 117-2013 Class 1
WARRANTY	10-Year

ITEM #	STYLE #	COLOR	PUT UP	WEIGHT	WIDTH
874922	4922-0000	Alpine Burgundy Pencil Stripe	65 yd.	9 oz.	46 in.
874928	4928-0000	Alpine/Beige 6-Bar (Beaufort)	65 yd.	9 oz.	46 in.

Sunbrella® Clarity

For awnings that are difficult to access for regular cleaning, look no further than Sunbrella® Clarity, an innovative awning fabric with low-maintenance attributes. Sunbrella Clarity features technology that works in two ways to help maintain a “like new” appearance. The first is a photoactive ingredient fueled by UV light even on cloudy days or in moderate shade. This action creates a natural cleaning mechanism that decomposes organic material such as volatile organic compounds (VOCs), grime, oils, mold and mildew.

The second part of the cleaning process is a hydrophilic or moisture spreading component that allows the surface of the fabric to wet out, washing away particles of inorganic matter on the surface. The fabric temporarily darkens, but returns to its original color after drying. Sunbrella Clarity features a coating that prevents water from penetrating through the awning.

FABRIC	Sunbrella Acrylic
FINISH	Polyurethane Undercoating
FR STANDARDS MET	California Technical Bulletin 117-2013 Class 1
WARRANTY	5-Year

ITEM #	STYLE #	COLOR	PUT UP	WEIGHT	WIDTH
892620	83020-0000	Beige	60 yd.	10 oz.	60 in.
892608	83008-0000	Black	60 yd.	10 oz.	60 in.
892631	83031-0000	Burgundy	60 yd.	10 oz.	60 in.
892630	83030-0000	Cadet Grey	60 yd.	10 oz.	60 in.
892646	83046-0000	Captain Navy	60 yd.	10 oz.	60 in.
892644	83044-0000	Charcoal Grey	60 yd.	10 oz.	60 in.
892637	83037-0000	Forest Green	60 yd.	10 oz.	60 in.
892603	83003-0000	Jockey Red	60 yd.	10 oz.	60 in.
892633	83033-0000	Linen	60 yd.	10 oz.	60 in.
892601	83001-0000	Pacific Blue	60 yd.	10 oz.	60 in.
892617	83017-0000	Royal Blue Tweed	60 yd.	10 oz.	60 in.
892645	83045-0000	Seagrass	60 yd.	10 oz.	60 in.
892602	83002-0000	Sunflower	60 yd.	10 oz.	60 in.
892648	83048-0000	Taupe	60 yd.	10 oz.	60 in.
892622	83022-0000	Terracotta	60 yd.	10 oz.	60 in.
892628	83028-0000	Toast	60 yd.	10 oz.	60 in.
892658	83058-0000	Tresco Brass	60 yd.	10 oz.	60 in.
892677	83077-0000	Tuscan	60 yd.	10 oz.	60 in.

Sunbrella® is a registered trademark of Glen Raven, Inc.





Sunbrella® Alloy

Sunbrella specialty shade product Alloy is a contemporary shade fabric featuring a metallic look with a unique shimmer. This streamlined product offers a soft hand and is available in four colorways.

Note: Solvent-based cleaners such as acetone, liquid fuels, paint thinners, mineral spirits and turpentine cannot be applied to Sunbrella Shade fabrics that contain PVC. Such solutions may accelerate the aging and degradation of the fabric.

FABRIC	11.4% Sunbrella Acrylic, 63.9% PVC, 24.7% Polyester
FINISH	Fluorocarbon
FR STANDARDS MET	California Technical Bulletin 117-2013 Class 1
WARRANTY	5-Year

ITEM #	STYLE #	COLOR	PUT UP	WEIGHT	WIDTH
875412	4401-0002	Alloy Bronze	45 yd.	15 oz.	60 in
875411	4401-0001	Alloy Silver	45 yd.	15 oz.	60 in
875413	4401-0003	Alloy Steel	45 yd.	15 oz.	60 in
875410	4401-0000	Alloy Vapor	45 yd.	15 oz.	60 in

Sunbrella® is a registered trademark of Glen Raven, Inc.



Sunbrella® Awning Jacquards

Fundamental is a specialty shade product available from Sunbrella for upscale, highly decorative applications. This jacquard features a houndstooth pattern, and is available in three colorways.

FABRIC	Sunbrella Acrylic
FINISH	Fluorocarbon
FR STANDARDS MET	California Technical Bulletin 117-2013 Class 1
WARRANTY	5-Year

ITEM #	STYLE #	COLOR	PUT UP	WEIGHT	WIDTH
875400	4400-0000	Fundamental Charcoal	60 yd.	10 oz.	54 in
875401	4400-0001	Fundamental Sand	60 yd.	10 oz.	54 in
875402	4400-0002	Fundamental Walnut	60 yd.	10 oz.	54 in

Sunbrella® is a registered trademark of Glen Raven, Inc.



Sunbrella® Unity

Renaissance fabrics were born from two objectives: creating beautiful vintage upholstery fabrics and recycling post-industrial fabric waste. Unity is the first Sunbrella Renaissance awning fabric. Crafted specifically for shade applications where subtle texture and distinctive detail creates a timeless charm, Unity is ideal for any awning.

FABRIC	Sunbrella Acrylic
FINISH	Fluorocarbon
FR STANDARDS MET	California Technical Bulletin 117-2013 Class 1
WARRANTY	5-Year

ITEM #	STYLE #	COLOR	PUT UP	WEIGHT	WIDTH
727500	85000-0000	Unity Ashe	60 yd.	12 oz.	60 in.
727502	85002-0000	Unity Char	60 yd.	12 oz.	60 in.
727504	85004-0000	Unity Garnet	60 yd.	12 oz.	60 in.
727501	85001-0000	Unity Granite	60 yd.	12 oz.	60 in.
727503	85003-0000	Unity Leaf	60 yd.	12 oz.	60 in.

Sunbrella® is a registered trademark of Glen Raven, Inc.

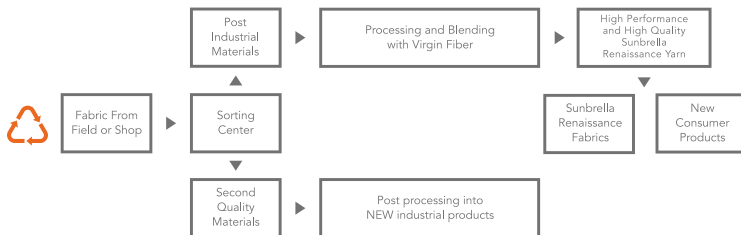

Sunbrella® And Mayfield Awning Display Complete

Featuring a slender 26" diameter footprint, this rotating display can hold up to 200 individual Sunbrella awning and marine fabric swatches (including the exclusive Mayfield collection). Viewing them is easy with removable fabric hangers that pivot 85°. Inset pockets below are specifically designed to hold official Sunbrella awning and marine selling tools like the swatch book, swatch cards and brochures.

The base features a recessed door that opens to a large storage compartment with shelves, perfect for storing additional fabric samples or Sunbrella selling tools.

Available only by drop shipment. Display includes a complete set of Sunbrella Awning and Sunbrella Mayfield samples.

ITEM #

999576

Sunbrella® is a registered trademark of Glen Raven, Inc.



SGS Thermal Lettering Film

Unlike SGS Thermal Digital Print Film, SGS Thermal Lettering Film is only intended for lettering and is not printable.

The film's adhesive layer is on the face side (top) of the film, meaning that it will have to be "reverse-plotted", weeded and then applied to the fabric without the need of transfer tape – like standard SGS film.

Sold in full rolls only.

ITEM #	STYLE #	COLOR	PUT UP	WIDTH
901677	VIX1026	Black	25.153 yd.	30 in.

SGS Thermal Digital Print Film

SGS Thermal Digital Print Film is a flexible urethane film which can be digitally printed and applied to Sunbrella® or other Glen Raven fabrics using the Sunbrella Graphics System to produce high quality, durable graphics for banners, umbrellas, covers and many other textile applications where flexibility of the fabric and film is needed. The adhesive is thermal activated, is dry to the touch at low temperatures and will remain dry to the touch once cooled. The adhesive can reduce the application time by 75% compared to other pressure sensitive films. The film can also be used unprinted for white lettering or graphics where printing is not required but the flexibility/durability is important. SGS Thermal Digital Print Film is suitable for use in most solvent, eco-solvent, and UV printers. Sold in full rolls only.

ITEM #	STYLE #	PUT UP	WIDTH
901676	1676-0000	25.153 yd.	30 in.
901678	1678-0000	25.153 yd.	60 in.

Sunbrella® is a registered trademark of Glen Raven, Inc.



Dickson North American Collection – Solids

The Dickson North American collection includes a vast selection of water-repellent, mildew-resistant solid fabrics. Its special finish delays the formation and accumulation of dirt. This fabric is colorfast and durable.

FABRIC	100% Solution Dyed Acrylic
FINISH	Water Repellent
WARRANTY	10-Year

ITEM #	STYLE #	COLOR	PUT UP	WEIGHT	WIDTH
897800	8600	Absythne (Willow)	65 yd.	8.55 oz.	47 in.
895104	7244	Amande (Avocado)	65 yd.	8.55 oz.	47 in.
895170	6028	Black	65 yd.	8.55 oz.	47 in.
895134	U225	Blue Jean	65 yd.	8.55 oz.	47 in.
895245	7104	Brick	65 yd.	8.55 oz.	47 in.
895208	U224	Brownie	65 yd.	8.55 oz.	47 in.
895206	8206	Burgundy	65 yd.	8.55 oz.	47 in.
895171	U171	Carbon	65 yd.	8.55 oz.	47 in.
895137	7554	Cassis	65 yd.	8.55 oz.	47 in.
895123	8903	Ciel	65 yd.	8.55 oz.	47 in.
895113	7703	Citron	65 yd.	8.55 oz.	47 in.
895195	6318	Corn	65 yd.	8.55 oz.	47 in.
895133	U141	Denim	65 yd.	8.55 oz.	47 in.
895135	0681	Dune	65 yd.	8.55 oz.	47 in.
895062	U104	Flanelle Gray	65 yd.	8.55 oz.	47 in.
895220	6687	Forest Green	65 yd.	8.55 oz.	47 in.
895064	U128	Frosty Chine	65 yd.	8.55 oz.	47 in.
895061	U105	Gold	65 yd.	8.55 oz.	47 in.
895175	6088	Gray	65 yd.	8.55 oz.	47 in.

ITEM #	STYLE #	COLOR	PUT UP	WEIGHT	WIDTH
895063	8396	Lead Chine	65 yd.	8.55 oz.	47 in.
895065	U131	Light Green Chine	65 yd.	8.55 oz.	47 in.
895060	8904	Linen	65 yd.	8.55 oz.	47 in.
895118	0867	Mandarine	65 yd.	8.55 oz.	47 in.
895201	0613	Marron (Brown)	65 yd.	8.55 oz.	47 in.
895103	7133	Natural	65 yd.	8.55 oz.	47 in.
895160	6022	Navy Blue	65 yd.	8.55 oz.	47 in.
895107	7264	Ocean Blue	65 yd.	8.55 oz.	47 in.
895221	0853	Olive	65 yd.	8.55 oz.	47 in.
895115	0018	Orange	65 yd.	8.55 oz.	47 in.
895114	8205	Papaya	65 yd.	8.55 oz.	47 in.
895202	3914	Paris Red	65 yd.	8.55 oz.	47 in.
895119	U134	Parma Chine	65 yd.	8.55 oz.	47 in.
895223	8201	Pearl Green	65 yd.	8.55 oz.	47 in.
895215	U170	Pink	65 yd.	8.55 oz.	47 in.
895121	U169	Purple	65 yd.	8.55 oz.	47 in.
895116	8016	Ramier	65 yd.	8.55 oz.	47 in.
895155	6020	Raw	65 yd.	8.55 oz.	47 in.
895117	7548	Raw Tweed/Beige	65 yd.	8.55 oz.	47 in.
895120	0020	Red	65 yd.	8.55 oz.	47 in.
895110	0017	Royal Blue	65 yd.	8.55 oz.	47 in.
895157	U132 (5092)	Straw	65 yd.	8.55 oz.	47 in.
895229	8207	Terra Cotta	65 yd.	8.55 oz.	47 in.
895225	6688	Turquoise (Aqua)	65 yd.	8.55 oz.	47 in.
895101	0001	White	65 yd.	8.55 oz.	47 in.
895190	6316	Yellow	65 yd.	8.55 oz.	47 in.

Dickson® is a registered trademark of Glen Raven, Inc.

Dickson North American Collection – Stripes

The Dickson North American collection includes a vast selection of water-repellent, mildew-resistant solid fabrics. Its special finish delays the formation and accumulation of dirt. This fabric is colorfast and durable.

FABRIC	100% Solution Dyed Acrylic
FINISH	Water Repellent
WARRANTY	10-Year

ITEM #	STYLE #	COLOR	PUT UP	WEIGHT	WIDTH
895873	8952	Algarve	65 yd.	8.55 oz.	47 in.
895445	6273	Baden Brown/Vanilla/Terra Cotta	65 yd.	8.55 oz.	47 in.
895455	6275	Baden Olive/Linen/Cream	65 yd.	8.55 oz.	47 in.
895847	7510	Beverly Black/White	65 yd.	8.55 oz.	47 in.
895395	6153	Beverly Burgundy/Silver	65 yd.	8.55 oz.	47 in.
895845	7508	Beverly Forest/White	65 yd.	8.55 oz.	47 in.
895846	7509	Beverly Sapphire/White	65 yd.	8.55 oz.	47 in.
896064	8164	Bilbao Black/Taupe/Natural (Charlotte)	65 yd.	8.55 oz.	47 in.
897630	8630	Boston Lime/Mint (Genoa)	65 yd.	8.55 oz.	47 in.
895750	D111	Brooklyn Amante	65 yd.	8.55 oz.	47 in.
895760	D112	Brooklyn Mandarin	65 yd.	8.55 oz.	47 in.
895762	D110	Brooklyn Pink	65 yd.	8.55 oz.	47 in.
895746	D050	Cadiz Dusk	65 yd.	8.55 oz.	47 in.
895754	D051	Cadiz Sunrise	65 yd.	8.55 oz.	47 in.
895749	8615	Capri	65 yd.	8.55 oz.	47 in.
895751	7465	Chicago (Casablanca)	65 yd.	8.55 oz.	47 in.
895426	5239	Castelo Linen/Rust/Beige (Oregon)	65 yd.	8.55 oz.	47 in.
895816	7466	Chicago (Casablanca)	65 yd.	8.55 oz.	47 in.
895420	6173	Davos Natural/Linen/Burgundy	65 yd.	8.55 oz.	47 in.
895955	7914	Goteborg Burgundy/Forest/Linen	65 yd.	8.55 oz.	47 in.
895956	7915	Goteborg Forest/Taupe	65 yd.	8.55 oz.	47 in.
897626	8626	Hanover Forest/Taupe/Linen (Cambridge)	65 yd.	8.55 oz.	47 in.
897612	8612	Hardelot Linen/Mustard/Cream	65 yd.	8.55 oz.	47 in.
895875	8935	Hardelot Tan/Beige/Natural	65 yd.	8.55 oz.	47 in.
895425	6228	Hossegor Linen/Blue/Gray	65 yd.	8.55 oz.	47 in.
895843	7506	Innsbruck Sebastian	65 yd.	8.55 oz.	47 in.
895879	8959	Londres Black With Narrow Stripe	65 yd.	8.55 oz.	47 in.
895876	8940	Londres Brown With Narrow Stripe	65 yd.	8.55 oz.	47 in.
895590	6671	Manchester Green/Peach Accent (Kent)	65 yd.	8.55 oz.	47 in.
895755	D103	Manosque Beige	65 yd.	8.55 oz.	47 in.
895743	D106	Manosque Blue	65 yd.	8.55 oz.	47 in.
895745	D104	Manosque Green	65 yd.	8.55 oz.	47 in.
895758	D108	Manosque Grey	65 yd.	8.55 oz.	47 in.
895744	D105	Manosque Violet	65 yd.	8.55 oz.	47 in.
895460	6276	Marza Brown/Linen/Natural (Jackson)	65 yd.	8.55 oz.	47 in.

ITEM #	STYLE #	COLOR	PUT UP	WEIGHT	WIDTH
895328	5328	Messina Green Yellow (Virginia)	65 yd.	8.55 oz.	47 in.
895329	5329	Messina Red/Gray (Virginia)	65 yd.	8.55 oz.	47 in.
895763	D115	Naples Black	65 yd.	8.55 oz.	47 in.
895740	D116	Naples Blue Jean	65 yd.	8.55 oz.	47 in.
895741	D117	Naples Denim	65 yd.	8.55 oz.	47 in.
895759	D113	Naples Grey	65 yd.	8.55 oz.	47 in.
895761	D114	Naples White	65 yd.	8.55 oz.	47 in.
895786	7351	Oslo Red/Gray/Splash Spun	65 yd.	8.55 oz.	47 in.
895254	8907	Paris Cadet Grey/Natural	65 yd.	8.55 oz.	47 in.
895757	C021	Paris Char	65 yd.	8.55 oz.	47 in.
895251	8553	Paris Lemon Yellow/White	65 yd.	8.55 oz.	47 in.
895748	C019	Paris Mimosa	65 yd.	8.55 oz.	47 in.
895861	8556	Paris Navy	65 yd.	8.55 oz.	47 in.
895252	8923	Paris Rouge Red/White	65 yd.	8.55 oz.	47 in.
895742	C020	Paris Sky	65 yd.	8.55 oz.	47 in.
895756	C018	Paris Wren	65 yd.	8.55 oz.	47 in.
895691	7124	Pompadour Red/White/Black	65 yd.	8.55 oz.	47 in.
895953	7408	Richmond Forest/Toast/Burgundy	65 yd.	8.55 oz.	47 in.
896126	8226	Rome Blue/Linen/Gray	65 yd.	8.55 oz.	47 in.
895752	8230	Saragosse	65 yd.	8.55 oz.	47 in.
896111	8211	Sienna Red/Linen	65 yd.	8.55 oz.	47 in.
895346	5346	Torres Rust/Beige/White (Oklahoma)	65 yd.	8.55 oz.	47 in.
895747	D047	Valencia	65 yd.	8.55 oz.	47 in.
895698	7130	Venezia Blue/Linen/White	65 yd.	8.55 oz.	47 in.
895753	6272	Windsor	65 yd.	8.55 oz.	47 in.
895510	6292	Windsor Yellow/White/Blue/Gray	65 yd.	8.55 oz.	47 in.

Dickson® is a registered trademark of Glen Raven, Inc.



Firesist®

Specifically designed for the commercial awning, canopy and shade markets, FIRESIST delivers a state-of-the-art combination of flame retardant performance and UV resistance.

FIRESIST fabric is woven from high UV and fade resistant solution dyed fiber with a proprietary coating and finish that results in superior weather, stain, mildew and flame resistance.

Extremely strong and tear resistant, FIRESIST is engineered for ease of fabrication, and features a lighter weight. FIRESIST's deep, rich colors deliver long lasting good looks and are color transfer resistant.

ITEM #	STYLE #	COLOR	PUT UP	WEIGHT	WIDTH
888500	82000-0000	Regatta	60 yd.	8.75 oz.	60 in.
888505	82005-0000	Regatta Tweed	60 yd.	8.75 oz.	60 in.
888506	82006-0000	Sand	60 yd.	8.75 oz.	60 in.
888513	82013-0000	Sunburst Yellow	60 yd.	8.75 oz.	60 in.
888514	82014-0000	Terra Cotta	60 yd.	8.75 oz.	60 in.
888512	82012-0000	Toasty Beige	60 yd.	8.75 oz.	60 in.

Firesist® is a registered trademark of Glen Raven, Inc.

FABRIC	Solution Dyed Polyester
FR STANDARDS MET	California State Fire Marshal Title 19; NFPA 701, Test Method 2; CPAI-84, Tent walls and roof; FMVSS 302; ASTM E84
WARRANTY	5-Year

ITEM #	STYLE #	COLOR	PUT UP	WEIGHT	WIDTH
888510	82010-0000	Admiral Navy	60 yd.	8.75 oz.	60 in.
888508	82008-0000	Black	60 yd.	8.75 oz.	60 in.
888516	82016-0000	Burgundy	60 yd.	8.75 oz.	60 in.
888517	82017-0000	Crimson Red	60 yd.	8.75 oz.	60 in.
888503	82003-0000	Forest Green	60 yd.	8.75 oz.	60 in.
888502	82002-0000	Forest Green Tweed	60 yd.	8.75 oz.	60 in.
888530	82030-0000	Grey	60 yd.	8.75 oz.	60 in.
888515	82015-0000	Ivory	60 yd.	8.75 oz.	60 in.



Weblon® Coastline Plus®

Coastline Plus awning fabric is a high performance PVC composite. It features a strong polyester base fabric, with manageable weight for excellent dimensional stability. The top surface is treated with the Rain Kleen® finish for color retention and prolonged fabric life. Coastline Plus is UV, water and mildew resistant. It is also heat-sealable for a strong, waterproof and airtight seal, and it accepts a variety of graphics including pressure sensitive graphics.

FABRIC	Vinyl Polyester Composite
FINISH	Vinyl Laminated, Kid-Embossed, Rain Kleen®
FR STANDARDS MET	California State Fire Marshal Title 19, NFPA 701 ASTM E84-81A Flame Spread Rating Class A (15)
WARRANTY	5-Year

ITEM #	STYLE #	COLOR	PUT UP	WEIGHT	WIDTH
857897	CP-2797	Almond	50 yd.	15 oz.	62 in.
857244	CP-2744	Aquamarine	50 yd.	15 oz.	62 in.
857225	CP-2725	Barque Brown	50 yd.	15 oz.	62 in.
857241	CP-2741	Bay Blue	50 yd.	15 oz.	62 in.
857206	CP-2706	Beacon Yellow	50 yd.	15 oz.	62 in.
857892	CP-2792	Beige	50 yd.	15 oz.	62 in.
857215	CP-2715	Burgundy	50 yd.	15 oz.	62 in.
857218	CP-2718	Charcoal Gray	50 yd.	15 oz.	62 in.
857205	CP-2705	Cork Brown	50 yd.	15 oz.	62 in.
857891	CP-2791	Dark Taupe	50 yd.	15 oz.	62 in.
857226	CP-2726	Deep Red	50 yd.	15 oz.	62 in.
857212	CP-2712	Deepsea Blue	50 yd.	15 oz.	62 in.
857219	CP-2719	Driftwood Gray	50 yd.	15 oz.	62 in.
857238	CP-2738	Ebbtide Tan	50 yd.	15 oz.	62 in.
857211	CP-2711	Glade Green	50 yd.	15 oz.	62 in.

ITEM #	STYLE #	COLOR	PUT UP	WEIGHT	WIDTH
857217	CP-2717	Gull Gray	50 yd.	15 oz.	62 in.
857201	CP-2701	Harbor Green	50 yd.	15 oz.	62 in.
857204	CP-2704	Island Turquoise	50 yd.	15 oz.	62 in.
857239	CP-2739	Ivory Coast	50 yd.	15 oz.	62 in.
857234	CP-2734	Jade	50 yd.	15 oz.	62 in.
857220	CP-2720	Mist Blue	50 yd.	15 oz.	62 in.
857247	CP-2747	Navy Blue	50 yd.	15 oz.	62 in.
857246	CP-2746	Ocean Blue	50 yd.	15 oz.	62 in.
857223	CP-2723	Panama Purple	50 yd.	15 oz.	62 in.
857245	CP-2745	Pirate Black	50 yd.	15 oz.	62 in.
857207	CP-2707	Portlight Red	50 yd.	15 oz.	62 in.
857209	CP-2709	Rust	50 yd.	15 oz.	62 in.
857290	CP-2790	Sail White	50 yd.	15 oz.	62 in.
857200	CP-2700	Sand	50 yd.	15 oz.	62 in.
857202	CP-2702	Sea Palm	50 yd.	15 oz.	62 in.
857233	CP-2733	Shell Pink	50 yd.	15 oz.	62 in.
857230	CP-2730	Sunrise Saffron	50 yd.	15 oz.	62 in.
857213	CP-2713	Sunset Orange	50 yd.	15 oz.	62 in.
857243	CP-2743	Teal	50 yd.	15 oz.	62 in.
857896	CP-2796	Terra Cotta	50 yd.	15 oz.	62 in.
857242	CP-2742	Tropic Green	50 yd.	15 oz.	62 in.

Weblon®, Coastline Plus® and Rain Kleen® are registered trademarks of Herculite Products Inc.

Weblon® Coastline Plus® Duplex

Coastline Plus Duplex are a selection of popular solid color topsides with complementing solid color underside.

FABRIC	Vinyl Polyester Composite
FINISH	Vinyl Laminated, Kid-Embossed, Rain Kleen®
FR STANDARDS MET	California State Fire Marshal Title 19, NFPA 701 ASTM E84-81A Flame Spread Rating Class A (15)
WARRANTY	5-Year

ITEM #	STYLE #	COLOR	PUT UP	WEIGHT	WIDTH
857250	CP-2750	Cork Brown/Sand	50 yd.	15 oz.	62 in.
857251	CP-2751	Glade Green/White	50 yd.	15 oz.	62 in.
857252	CP-2752	Rust/Ivory	50 yd.	15 oz.	62 in.

Weblon®, Coastline Plus® and Rain Kleen® are registered trademarks of Herculite Products Inc.

Weblon® Coastline Plus® Continental Stripes

Coastline Plus Continental Stripes are a superb selection of three-color stripe awning fabric designs. Continental linings are keyed to the lighter stripe shades.

FABRIC	Vinyl Polyester Composite
FINISH	Vinyl Laminated, Kid-Embossed, Rain Kleen®
FR STANDARDS MET	California State Fire Marshal Title 19, NFPA 701 ASTM E84-81A Flame Spread Rating Class A (15)
WARRANTY	5-Year

ITEM #	STYLE #	COLOR	PUT UP	WEIGHT	WIDTH
857287	CP-2887	Rust/Dark Brown	50 yd.	15 oz.	62 in.
857282	CP-2882	Sand/Olive on Ivory	50 yd.	15 oz.	62 in.

Weight varies slightly from color to color. Weight and roll size nominal. Their values are subject to slight variation and are not intended to be used as specifications.

If fabric awning valance is subject to wind whipping, we recommend that the valance be faced, framed or weighted.

Weblon®, Coastline Plus® and Rain Kleen® are registered trademarks of Herculite Products Inc.



Weblon® Coastline Plus® Linen Back

Coastline Plus Linen Back fabrics feature a colorful solid top side all decked out with a linen print underside.

FABRIC	Vinyl Polyester Composite
FINISH	Vinyl Laminated, Kid-Embossed, Rain Kleen®
FR STANDARDS MET	California State Fire Marshal Title 19, NFPA 701 ASTM E84-81A Flame Spread Rating Class A (15)
WARRANTY	5-Year

ITEM #	STYLE #	COLOR	PUT UP	WEIGHT	WIDTH
857112	CP-2812	Deepsea Blue/Mist Blue	50 yd.	15 oz.	62 in.
857111	CP-2811	Glade Green/Jade	50 yd.	15 oz.	62 in.
857156	CP-2856	Metallic Silver/Silver	50 yd.	15 oz.	62 in.

Weight varies slightly from color to color. Weight and roll size nominal. Their values are subject to slight variation and are not intended to be used as specifications.

If fabric awning valance is subject to wind whipping, we recommend that the valance be faced, framed or weighted.

Weblon®, Coastline Plus® and Rain Kleen® are registered trademarks of Herculite Products Inc.

Weblon® Coastline Plus® Traditional Stripes

Coastline Plus Traditional Stripes are classic four-bar stripes, in plenty of rich two-color combinations with solid undersides.

FABRIC	Vinyl Polyester Composite
FINISH	Vinyl Laminated, Kid-Embossed, Rain Kleen®
FR STANDARDS MET	California State Fire Marshal Title 19, NFPA 701 ASTM E84-81A Flame Spread Rating Class A (15)
WARRANTY	5-Year

ITEM #	STYLE #	COLOR	PUT UP	WEIGHT	WIDTH
857273	CP-2773	Brite Red/White	50 yd.	15 oz.	62 in.
857275	CP-2775	Cork and Sand/Sand	50 yd.	15 oz.	62 in.
857272	CP-2772	Deep Sea Blue/White	50 yd.	15 oz.	62 in.
857261	CP-2761	Glade Green and White/White	50 yd.	15 oz.	62 in.
857270	CP-2770	Pirate Black and White/White	50 yd.	15 oz.	62 in.
857274	CP-2774	Turquoise and White/Turquoise	50 yd.	15 oz.	62 in.

Weight varies slightly from color to color. Weight and roll size nominal. Their values are subject to slight variation and are not intended to be used as specifications. If fabric awning valance is subject to wind whipping, we recommend that the valance be faced, framed or weighted.

Weblon®, Coastline Plus® and Rain Kleen® are registered trademarks of Herculite Products



Patio 500®

Patio 500 has exceptional resistance to mildew and UV rays making this waterproof fabric the perfect choice for awnings, canopies and commercial installations in sunny, high humidity areas. Made with wick and craze resistant polyester weft-inserted warp knit scrim, Patio 500 has a matte, linen-like finish that combines long-lasting good looks with exceptional dimensional stability and superior strength. It accepts graphics including heat-sealed and inset fabrics, silk screening, hand painting, appliqué and more. Pressure sensitive adhesive vinyl graphics are not recommended. The underside of the fabric is the same color unless otherwise noted as duplex (different colors for the top and bottom).

FABRIC	Vinyl Laminated Polyester
FR STANDARDS MET	California State Fire Marshal, F-12102; NFPA 701; ASTM E84, Class A
WARRANTY	5-Year (excluding pattern 513 Clear)

ITEM #	STYLE #	COLOR	PUT UP	WEIGHT	WIDTH
858539	539	Bay Blue	50 yd.	17.5 oz.	61 in.
858522	522	Beige	50 yd.	17.5 oz.	61 in.
858508	508	Black	50 yd.	17.5 oz.	61 in.
858529	529	Bright Red	50 yd.	17.5 oz.	61 in.
858516	516	Brown	50 yd.	17.5 oz.	61 in.
858515	515	Buff	50 yd.	17.5 oz.	61 in.
858527	527	Burgundy	50 yd.	17.5 oz.	61 in.
858537	537	Champagne	50 yd.	17.5 oz.	61 in.
858513	513	Clear	50 yd.	17.5 oz.	61 in.
858536	536	Cobalt Blue	50 yd.	17.5 oz.	61 in.
858581	581	Cobalt/Eggshell (Duplex)	50 yd.	17.5 oz.	61 in.
858510	510	Dark Green	50 yd.	17.5 oz.	61 in.
858541	541	Designer White	50 yd.	17.5 oz.	61 in.
858518	518	Dusky Blue	50 yd.	17.5 oz.	61 in.
858524	524	Eggshell	50 yd.	17.5 oz.	61 in.
858562	562	Emerald	50 yd.	17.5 oz.	61 in.
858580	580	Emerald/Eggshell (Duplex)	50 yd.	17.5 oz.	61 in.
858525	525	English Brown	50 yd.	17.5 oz.	61 in.
858587	587	English Brown/Eggshell (Duplex)	50 yd.	17.5 oz.	61 in.
858567	567	Jade	50 yd.	17.5 oz.	61 in.
858514	514	Lime Green	50 yd.	17.5 oz.	61 in.
858538	538	Parchment	50 yd.	17.5 oz.	61 in.
858528	528	Pewter	50 yd.	17.5 oz.	61 in.
858565	565	Reef Blue	50 yd.	17.5 oz.	61 in.
858503	503	Royal Blue	50 yd.	17.5 oz.	61 in.
858545	545	Ruby	50 yd.	17.5 oz.	61 in.
858506	506	Slate Gray	50 yd.	17.5 oz.	61 in.
858543	543	Spruce	50 yd.	17.5 oz.	61 in.
858570	570	Summer Ivy	50 yd.	17.5 oz.	61 in.
858566	566	Sunflower	50 yd.	17.5 oz.	61 in.
858544	544	Sunset Orange	50 yd.	17.5 oz.	61 in.
858564	564	Teal	50 yd.	17.5 oz.	61 in.
858526	526	Terra Cotta	50 yd.	17.5 oz.	61 in.
858540	540	Timber	50 yd.	17.5 oz.	61 in.
858523	523	White	50 yd.	17.5 oz.	61 in.

Patio 500® is a registered trademark of Herculite Products Inc.



Weblon® Vanguard®

Built to last, and backed by an eight-year manufacturer's limited warranty. Vanguard is wick-resistant and reinforced with ultra-high strength 1000-denier polyester. 10-mil thick vinyl ply on the weatherside increases the life of any awning installation. Rain Kleen® surface treatments prolongs fabric life and preserves color intensity. Superior water, mildew and ultraviolet resistance. Dimensionally stable and compatible with a variety of graphic applications (including pressure sensitive graphics).

FABRIC	Wick-Resistant Polyester
FINISH	Vinyl Laminated, Kid-Embossed, Clear Rain Kleen® Top Coat
FR STANDARDS MET	California State Fire Marshal Title 19, NFPA 701 ASTM E84-81A Flame Spread Rating Class A (15)
WARRANTY	8-Year

ITEM #	STYLE #	COLOR	PUT UP	WEIGHT	WIDTH
857997	2997	Almond	50 yd.	17 oz.	62 in.
857945	2945	Black	50 yd.	17 oz.	62 in.
857915	2915	Burgundy	50 yd.	17 oz.	62 in.
857984	2984	Colonial Blue	50 yd.	17 oz.	62 in.
857926	2926	Deep Red	50 yd.	17 oz.	62 in.
857912	2912	Deepsea Blue	50 yd.	17 oz.	62 in.
857988	2988	Designer White	50 yd.	17 oz.	62 in.
857919	2919	Driftwood Gray	50 yd.	17 oz.	62 in.
857911	2911	Glade Green	50 yd.	17 oz.	62 in.
857939	2939	Ivory	50 yd.	17 oz.	62 in.
857946	2946	Ocean Blue	50 yd.	17 oz.	62 in.
857909	2909	Rust	50 yd.	17 oz.	62 in.
857900	2900	Sand	50 yd.	17 oz.	62 in.
857938	2938	Tan	50 yd.	17 oz.	62 in.

Weblon®, Vanguard® and Rain Kleen® are registered trademarks of Herculite Products Inc.



Herculite® Natura™

Herculite Natura Awning Fabric is a revolutionary textile that features the look and feel of woven cloth on both sides. The fabric is completely waterproof, weather-tight and highly flame resistant. This high performance textile is perfect for commercial awnings and canopies designed to protect people and furnishings from the sun's harsh UV rays while providing a natural fabric design element. Herculite Natura features the Rain-Kleen® II protective finish, and resists stain and mildew. This dimensionally stable fabric is digitally printable and heat and RF sealable.

FABRIC	100% Vinyl Composite Supported by a Polyester Substrate
FINISH	Rain-Kleen II®
FR STANDARDS MET	California State Fire Marshal Title 19; NFPA 701; ASTM E84-81A Flame Spread Rating Class A (15)
WARRANTY	8-Year

ITEM #	STYLE #	COLOR	PUT UP	WEIGHT	WIDTH
807739	NT7739	Antique White	50 yd.	18 oz.	62 in.
807725	NT7725	Barque Brown	50 yd.	18 oz.	62 in.
807709	NT7709	Barrel Tile	50 yd.	18 oz.	62 in.
807745	NT7745	Black	50 yd.	18 oz.	62 in.
807738	NT7738	Burlywood	50 yd.	18 oz.	62 in.
807715	NT7715	Cabernet	50 yd.	18 oz.	62 in.
807726	NT7726	Deep Red	50 yd.	18 oz.	62 in.
807788	NT7788	Digital White	50 yd.	18 oz.	62 in.
807711	NT7711	Evergreen	50 yd.	18 oz.	62 in.
807712	NT7712	Midnight Blue	50 yd.	18 oz.	62 in.
807747	NT7747	Navy	50 yd.	18 oz.	62 in.

Natura™ is a trademark of Herculite Products Inc. Herculite® and Rain-Kleen® are registered trademarks of Herculite Products Inc.

Herculite® Excel M Series™

Excel M Series is a revolutionary architectural textile composite. Engineered-in-America, it utilizes a unique hybrid construction which delivers exceptional tear and tensile strength blended with flexibility and softness.

Excel M Series surface is protected with our Rain-Kleen® Fluoropolymer and comes with our elegant Pearl-Luster finish providing incomparable abrasion and scratch resistance as well as extraordinary aesthetic appeal.

It is 100% waterproof, heat and RF weldable, and is well suited for commercial and residential structures alike. It is engineered to protect people and furnishings from weather while maintaining an architectural fabric statement of sustainability.

FABRIC	100% Vinyl Composite Supported by a Polyester Substrate
FINISH	Rain-Kleen®
FR STANDARDS MET	California State Fire Marshal Title 19; NFPA 701; ASTM E-84
WARRANTY	8-Year

ITEM #	STYLE #	COLOR	PUT UP	WEIGHT	WIDTH
856808	XL5045	Black	50 yd.	18 oz.	62 in.
856813	XL5088	Brite White	50 yd.	18 oz.	62 in.
856804	XL5015	Burgundy	50 yd.	18 oz.	62 in.
856803	XL5012	Dark Blue	50 yd.	18 oz.	62 in.
856812	XL5011	Glade Green	50 yd.	18 oz.	62 in.
856807	XL5039	Ivory	50 yd.	18 oz.	62 in.
856809	XL5046	Medium Blue	50 yd.	18 oz.	62 in.
856810	XL5047	Navy	50 yd.	18 oz.	62 in.
856805	XL5026	Red	50 yd.	18 oz.	62 in.
856802	XL5009	Rust	50 yd.	18 oz.	62 in.
856811	XL5090	Sail White	50 yd.	18 oz.	62 in.
856801	XL5000	Sand	50 yd.	18 oz.	62 in.
856806	XL5038	Tan	50 yd.	18 oz.	62 in.
856800	XL5088T	Translucent White	50 yd.	18 oz.	62 in.

Excel M Series™ is a trademark of Herculite Products Inc. Herculite® and Rain-Kleen® are registered trademarks of Herculite Products Inc.



Serge Ferrari Précontraint® 502 Satin

Précontraint 502 Satin is an evolution of the classic version of Précontraint 502 that has been a staple in North America for awnings, canopies, shade sails and light structures for the last 25 years. The new product has all the same performance characteristic as its predecessor, including dimensional stability, excellent UV resistance, heat and weather protection, and color retention and strength for long-term aesthetics and durability. However, Précontraint 502 Satin offers two new added benefits – a more desirable satin finish, compared with the classic’s glossy finish, and a new PVDF topcoat on both sides for exceptional long-term dirt resistance. Available with a 10-year warranty on fixed framed awnings and canopies (static applications) and 5-years for tents, tensile structure and retractable awnings (non-static applications).

FABRIC	High-Tenacity Polyester
FINISH	PVDF Topcoat On Both Sides
FR STANDARDS MET	California State Fire Marshal Title 19; Method 1/NFPA 701; Class A ASTM E-84
WARRANTY	10-Year

ITEM #	STYLE #	COLOR	PUT UP	WEIGHT	WIDTH
878417	502V2-2168C	Alu	43 yd.	16.7 oz.	70.9 in.
878411	502V2-2157C	Aniseed	43 yd.	16.7 oz.	70.9 in.
878405	502V2-2138C	Autumn	43 yd.	16.7 oz.	70.9 in.
878438	502V2-8450C	Black	43 yd.	16.7 oz.	70.9 in.
878418	502V2-2171C	Boulder	43 yd.	16.7 oz.	70.9 in.
878436	502V2-8284C	Burgundy	43 yd.	16.7 oz.	70.9 in.
878415	502V2-2166C	Buttercup	43 yd.	16.7 oz.	70.9 in.
878406	502V2-2141C	Camel	43 yd.	16.7 oz.	70.9 in.
878419	502V2-2172C	Carrot	43 yd.	16.7 oz.	70.9 in.
878429	502V2-50675C	Celadon	43 yd.	16.7 oz.	70.9 in.
878426	502V2-50672C	Celestial Blue	43 yd.	16.7 oz.	70.9 in.
878437	502V2-8341C	Champagne	43 yd.	16.7 oz.	70.9 in.

ITEM #	STYLE #	COLOR	PUT UP	WEIGHT	WIDTH
878407	502V2-2148C	Cocoa	43 yd.	16.7 oz.	70.9 in.
878416	502V2-2167C	Concrete	43 yd.	16.7 oz.	70.9 in.
878427	502V2-50673C	Dark Blue	43 yd.	16.7 oz.	70.9 in.
878425	502V2-50671C	Dijon	43 yd.	16.7 oz.	70.9 in.
878420	502V2-50265C	Hemp	43 yd.	16.7 oz.	70.9 in.
878413	502V2-2160C	Lagoon	43 yd.	16.7 oz.	70.9 in.
878428	502V2-50674C	Lemon	43 yd.	16.7 oz.	70.9 in.
878400	502V2-1125C	Marine	43 yd.	16.7 oz.	70.9 in.
878414	502V2-2161C	Midnight Blue	43 yd.	16.7 oz.	70.9 in.
878412	502V2-2158C	Moss Green	43 yd.	16.7 oz.	70.9 in.
878422	502V2-50668C	Olive	43 yd.	16.7 oz.	70.9 in.
878434	502V2-8204C	Orange	43 yd.	16.7 oz.	70.9 in.
878401	502V2-2012C	Pepper	43 yd.	16.7 oz.	70.9 in.
878424	502V2-50670C	Porcelain Green	43 yd.	16.7 oz.	70.9 in.
878408	502V2-2150C	Raspberry	43 yd.	16.7 oz.	70.9 in.
878435	502V2-8255C	Red	43 yd.	16.7 oz.	70.9 in.
878403	502V2-2135C	Sandy Beige	43 yd.	16.7 oz.	70.9 in.
878410	502V2-2156C	Spruce	43 yd.	16.7 oz.	70.9 in.
878430	502V2-50676C	Steel Blue	43 yd.	16.7 oz.	70.9 in.
878423	502V2-50669C	Teak	43 yd.	16.7 oz.	70.9 in.
878432	502V2-8056C	Tennis Green	43 yd.	16.7 oz.	70.9 in.
878402	502V2-20185C	Terracotta	43 yd.	16.7 oz.	70.9 in.
878421	502V2-50270C	Thistle Blue	43 yd.	16.7 oz.	70.9 in.
878439	502V2-8861C	Vanilla	43 yd.	16.7 oz.	70.9 in.
878409	502V2-2152C	Velvet Red	43 yd.	16.7 oz.	70.9 in.
878431	502V2-50677C	Victoria Blue	43 yd.	16.7 oz.	70.9 in.
878404	502V2-2137C	Walnut Stain	43 yd.	16.7 oz.	70.9 in.
878433	502V2-8102C	White	43 yd.	16.7 oz.	70.9 in.

Précontraint® is a registered trademark of The Serge Ferrari Group.

STAM 6002L

STAM 6002L is a high-performance material for open-air habitats, eco-lodges, canopies, pergolas, small tents and lightweight tensioned structures. It's high-tenacity polyester micro-yarn base cloth provides exceptional flexibility and strength, while ensuring maximum structural resistance to elongation and tearing. 100% waterproof, the PVDF finish ensures long-term resistance to UV radiation and dirt. Phthalate-free, GREENGUARD® certified, compliant with current REACH regulations and 100% recyclable through the Serge Ferrari Texyloop® operational recycling network. Available with an 8-year warranty on fixed framed awnings and canopies (static applications) and 5-years for tents, tensile structure and retractable awnings (non-static applications).

FABRIC	High-Tenacity Polyester
FINISH	PVDF Topcoat
FR STANDARDS MET	California State Fire Marshal Title 19; NFPA 701 Method 1 & 2; ASTM E-84 Class A
WARRANTY	8-Year

ITEM #	STYLE #	COLOR	PUT UP	WEIGHT	WIDTH
742260	6002L-20191	Beige	54.7 yd.	14.7 oz.	66.9 in.
742251	6002L-20007	Black	54.7 yd.	14.7 oz.	66.9 in.
742258	6002L-20186	Burgundy	54.7 yd.	14.7 oz.	66.9 in.
742264	6002L-50667	Caribbean Blue	54.7 yd.	14.7 oz.	66.9 in.
742261	6002L-20204	Chocolate	54.7 yd.	14.7 oz.	66.9 in.
742252	6002L-20024	Grey	54.7 yd.	14.7 oz.	66.9 in.
742263	6002L-2160	Lagoon	54.7 yd.	14.7 oz.	66.9 in.
742259	6002L-20189	Navy	54.7 yd.	14.7 oz.	66.9 in.
742253	6002L-2012	Pepper	54.7 yd.	14.7 oz.	66.9 in.
742262	6002L-2156	Spruce	54.7 yd.	14.7 oz.	66.9 in.
742254	6002L-20165	Taupe	54.7 yd.	14.7 oz.	66.9 in.
742256	6002L-20184	Tennis Green	54.7 yd.	14.7 oz.	66.9 in.
742257	6002L-20185	Terracotta	54.7 yd.	14.7 oz.	66.9 in.
742250	6002L-10387	Vanilla	54.7 yd.	14.7 oz.	66.9 in.
742255	6002L-20183	White	54.7 yd.	14.7 oz.	66.9 in.

GREENGUARD® is a registered trademark of GREENGUARD Environmental Institute. Texyloop® is a registered trademark of Serge Ferrari SAS.



Weathertyte®

Designed for a variety of awning and sign applications, Weathertyte is a weatherproof awning material with the look and feel of textured decorative fabric. This high-performance composite vinyl substrate is flame-resistant, easy to handle and highly durable.

Weathertyte is ideal for a variety of awning and canopy applications including restaurant, hospitality, retail, business and residential. It's digitally printable with solvent-based inks and accepts silk screen and spray paint. Weathertyte is easy to clean, and resists stains and mildew.

FABRIC	Polyester
FINISH	Vinyl/Acrylic
FR STANDARDS MET	California State Fire Marshal Title 19, Section 1237; ASTM E84 Class A; NFPA 701; UL Listed
WARRANTY	8-Year

ITEM #	STYLE #	COLOR	PUT UP	WEIGHT	WIDTH
839901	WT-76BK	Black	50 yd.	16 oz.	74 in.
839902	WT-76B	Blue	50 yd.	16 oz.	74 in.
839912	WT-76BWN	Brown	50 yd.	16 oz.	74 in.
839907	WT-76BU	Burgundy	50 yd.	16 oz.	74 in.
839913	WT-76CHR	Charcoal	50 yd.	16 oz.	74 in.
839910	WT-76DBL	Dark Blue	50 yd.	16 oz.	74 in.
839908	WT-76DRD	Dark Red	50 yd.	16 oz.	74 in.
839909	WT-76FGR	Forest Green	50 yd.	16 oz.	74 in.
839903	WT-76GR	Green	50 yd.	16 oz.	74 in.
839905	WT-76LN	Linen	50 yd.	16 oz.	74 in.
839920	WT-76ORG	Orange	50 yd.	16 oz.	74 in.
839906	WT-76RD	Red	50 yd.	16 oz.	74 in.
839914	WT-76SLT	Sapphire/Slate Blue	50 yd.	16 oz.	74 in.
839911	WT-76SUN	Sunflower Yellow	50 yd.	16 oz.	74 in.
839915	WT-76TRC	Terracotta Red	50 yd.	16 oz.	74 in.
839940	WT-60WT	White	50 yd.	16 oz.	60 in.
839930	WT-54WT	White	50 yd.	16 oz.	54 in.
839900	WT-76WT	White	50 yd.	16 oz.	74 in.

Weathertyte® is a registered trademark of the Cooley Group.



Main Street® +

Main Street + is ideal for awnings and canopies because it won't stretch, leak or fade even after years of exposure. This versatile fabric features a smooth surface for even greater looks and resistance to dirt build-up. It offers superior strength and resistance to water, mildew, ultraviolet rays and abrasion for many applications, indoors and out. Main Street + is easy to fabricate without puckering or fraying. It readily accepts graphics including sewn-in inset fabrics, screen-printing and hand painting.

FABRIC	Polyester
FINISH	Acrylic Coated Both Sides
FR STANDARDS MET	California State Fire Marshal; NFPA 701, Test Method 2; ASTM E84
WARRANTY	5-Year

ITEM #	STYLE #	COLOR	PUT UP	WEIGHT	WIDTH
808264	214MS+	Black	50 yd.	9 oz.	61 in.
808281	236MS+	Brown	50 yd.	9 oz.	61 in.
808280	235MS+	Cool Grey	50 yd.	9 oz.	61 in.
808260	210MS+	Cranberry	50 yd.	9 oz.	61 in.
808277	227MS+	Dark Linen	50 yd.	9 oz.	61 in.
808274	224MS+	Navy	50 yd.	9 oz.	61 in.
808282	237MS+	Olive	50 yd.	9 oz.	61 in.
808275	225MS+	Terra Cotta	50 yd.	9 oz.	61 in.
808261	211MS+	Toast	50 yd.	9 oz.	61 in.
808265	215MS+	White	50 yd.	9 oz.	61 in.

Main Street® is a registered trademark of Glen Raven, Inc.

Weathertyte® Lite

Weathertyte Lite Awning Fabric is a lighter-weight material which offers excellent weatherability and strength in a cost-effective composite membrane. As a digitally printable substrate, options for custom designed awnings, canopies or umbrellas are virtually endless.

Weathertyte's inherent waterproof properties make it easy to clean and resistant to stains and fungal growth. The lighter weight of Weathertyte Lite makes it easier to handle during fabrication and installation.

FABRIC	Polyester
FINISH	Vinyl/Acrylic
FR STANDARDS MET	California State Fire Marshal Title 19, Section 1237; ASTM E84 Class A; NFPA 701; UL Listed
WARRANTY	5-Year

ITEM #	STYLE #	COLOR	PUT UP	WEIGHT	WIDTH
839970	WTL-74DSBLK	Black/Black	50 yd.	11 oz.	74 in.
839972	WTL-74DSBLU	Blue/Blue	50 yd.	11 oz.	74 in.
839974	WTL-74DSBUR	Burgundy/Burgundy	50 yd.	11 oz.	74 in.
839976	WTL-74DSRD	Dark Red/Dark Red	50 yd.	11 oz.	74 in.
839971	WTL-74DSFGR	Forest Green/Forest Green	50 yd.	11 oz.	74 in.
839973	WTL-74DSLIN	Linen/Linen	50 yd.	11 oz.	74 in.
839978	WTL-74DSWHT	White/White	50 yd.	11 oz.	74 in.

Weathertyte® is a registered trademark of the Cooley Group.

Starfire®

A tough and long-lasting, yet soft and flexible fabric, Starfire can be used for a variety of applications including awnings, banners, outdoor umbrellas and tents. Finished with an acrylic topcoat, Starfire is easy to clean and resists fading, rotting and structural weakening from prolonged exposure to the sun and other damaging elements. Starfire is also water, soil and mildew resistant. This fabric is easy to handle and install. Starfire is often specified where a cloth-like appearance is desired.

FABRIC	45% Polyester/55% Cotton
FINISH	Pigmented and Acrylic Top coated
FR STANDARDS MET	California State Fire Marshal; NFPA 701 Test Method 2; ASTM E84
WARRANTY	5-Year Pro Rated

ITEM #	STYLE #	COLOR	PUT UP	WEIGHT	WIDTH
855722	722	Black	45 yd.	15 oz.	60 in.
855702	702	Bone White	45 yd.	15 oz.	60 in.
855720	720	Brown	45 yd.	15 oz.	60 in.
855708	708	Eggshell	45 yd.	15 oz.	60 in.
855701	701	Emerald Green	45 yd.	15 oz.	60 in.
855703	703	Forest Green	45 yd.	15 oz.	60 in.
855788	788	Khaki	45 yd.	15 oz.	60 in.
855719	719	Off White	45 yd.	15 oz.	60 in.
855753	753	Pearl Gray	45 yd.	15 oz.	60 in.
855707	707	Red	45 yd.	15 oz.	60 in.
855712	712	Royal Blue	45 yd.	15 oz.	60 in.
855749	749	Tan	45 yd.	15 oz.	60 in.
855713	713	Tangerine	45 yd.	15 oz.	60 in.
855704	704	Teal Blue	45 yd.	15 oz.	60 in.
855714	714	Terra Cotta	45 yd.	15 oz.	60 in.
855717	717	White	45 yd.	15 oz.	60 in.

Starfire® is a registered trademark of Glen Raven, Inc.

Calabaña®

An excellent choice for awnings and canopies, Calabaña cloth is both strong and flexible, with unique self-contouring characteristics. Fabric beauty is protected by invisible organosol shield, for non-glare dirt repellency and mildew resistance. Exposure shrinkage is approximately 2% to 5% depending upon atmospheric conditions.

FABRIC	Cotton Army Duck
FINISH	Vinyl Coated
WARRANTY	5-Year

ITEM #	STYLE #	COLOR	PUT UP	WEIGHT	WIDTH
826900	6900	Black	50 yd. pieces, 150 yd. cartons	15 oz.	31 in.
826929	6929	Bordeaux	50 yd. pieces, 150 yd. cartons	15 oz.	31 in.
826918	6918	Charcoal	50 yd. pieces, 150 yd. cartons	15 oz.	31 in.
826910	6910	Chocolate Brown	50 yd. pieces, 150 yd. cartons	15 oz.	31 in.
826911	6911	Emerald Green	50 yd. pieces, 150 yd. cartons	15 oz.	31 in.
826939	6939	Sandstone	50 yd. pieces, 150 yd. cartons	15 oz.	31 in.
826909	6909	Terrace Red	50 yd. pieces, 150 yd. cartons	15 oz.	31 in.
826917	6917	White	50 yd. pieces, 150 yd. cartons	15 oz.	31 in.

Calabaña® is a registered trademark of Graniteville Specialty Fabrics.



Nite-Lite®

Made from wick and craze resistant polyester scrim, Nite-Lite is an exceptional back-lit fabric that features vivid colors with a translucent white underside for spectacular illumination. An acrylic top coat makes this fabric easier to clean and extends its life by enhancing its resistance to UV, rot, mildew, stains and dirt. This durable fabric accepts pressure sensitive graphics as well as sewn-in and heat sealed inset fabrics, silk-screening and hand painting.

FABRIC	Vinyl Laminated Polyester
FINISH	Acrylic Top Coat
FR STANDARDS MET	California State Fire Marshal Title 19; NFPA 701 Test Method 2
WARRANTY	8-Year

ITEM #	STYLE #	COLOR	PUT UP	WEIGHT	WIDTH
812608	2608	Black	40 yd.	16 oz.	61 in.
812631	2631	Bordeaux	40 yd.	16 oz.	61 in.
812675	2675	Dark Blue	40 yd.	16 oz.	61 in.
812637	2637	Forest Green	40 yd.	16 oz.	61 in.
812600	2600	Green	40 yd.	16 oz.	61 in.
812601	2601	Marine Blue	40 yd.	16 oz.	61 in.
812676	2676	Mid Red	40 yd.	16 oz.	61 in.
812603	2603	Red	40 yd.	16 oz.	61 in.
812628	2628	Tan	40 yd.	16 oz.	61 in.
812604	2604	White	40 yd.	16 oz.	61 in.
812602	2602	Yellow	40 yd.	16 oz.	61 in.

Nite-Lite® is a registered trademark of Glen Raven, Inc.

Cool Glo™ / Northstar®

Distributed exclusively by Trivantage®, Cool Glo/NorthStar is designed specifically for back-lit awnings and signs. It features the same color on the face and back of the fabric, creating a warm, soothing glow beneath an awning or sign. Provides maximum brilliance and consistent translucency. Highly resistant to ultraviolet light, mildew, rot and water and has strong resilience to fade, weather, scuff and abrasion. Exhibits excellent tensile and tear strength. Compatible with a variety of graphics applications, including paint, heat transfer and screen printing.

FABRIC	Woven Polyester
FINISH	Vinyl Coated
FR STANDARDS MET	California State Fire Marshal Title 19; NFPA 701
WARRANTY	5-Year

ITEM #	STYLE #	COLOR	PUT UP	WEIGHT	WIDTH
850949	CE1749	Black	40 yd.	13 oz.	61 in.
850921	CE1701	Blue	40 yd.	13 oz.	61 in.
850951	CE1751	Hot Pink	40 yd.	13 oz.	61 in.
850942	CE1742	Ivory	40 yd.	13 oz.	61 in.
850938	CE1738	Kelly Green	40 yd.	13 oz.	61 in.
850925	CE1705	Orange	40 yd.	13 oz.	61 in.
850936	CE1736	Red	40 yd.	13 oz.	61 in.
850950	CE1750	White	40 yd.	13 oz.	61 in.
850960	CE1790	Winterberry	40 yd.	13 oz.	61 in.
850930	CE1730	Yellow	40 yd.	13 oz.	61 in.

Cool Glo™ is a trademark of Glen Raven, Inc. Northstar® and Trivantage® are registered trademarks of Glen Raven, Inc.



Eradi-Lite®

Eradi-Lite is a flexible and anti-crazing eradicable backlit awning and sign fabric made of a lightweight vinyl-laminated polyester fabric with an acrylic topcoat. The fabric features a unique blend of plasticizers and elastomers, which make the material resistant to plasticizer migration and staining or abrasion, while still remaining highly flexible.

FABRIC	Vinyl Laminated Polyester
FINISH	Eradicable Coating
FR STANDARDS MET	California State Fire Marshal Title 19, Section 1237; NFPA 701, Test Method 2
WARRANTY	8-Year (5-Year U.S. Desert Southwest)

ITEM #	STYLE #	COLOR	PUT UP	WEIGHT	WIDTH
853828	2728	Black	30 yd.	17 oz.	78 in.
853814	2714	Burgundy	30 yd.	17 oz.	78 in.
853806	2706	Dark Blue	30 yd.	17 oz.	78 in.
853822	2722	Forest Green	30 yd.	17 oz.	78 in.
853820	2720	Green	30 yd.	17 oz.	78 in.
853804	2704	Mid Blue	30 yd.	17 oz.	78 in.
853810	2710	Mid Red	30 yd.	17 oz.	78 in.
853851	2751	Orange	30 yd.	17 oz.	78 in.
853812	2712	Red	30 yd.	17 oz.	78 in.
853854	2754	Reflex Blue	30 yd.	17 oz.	78 in.
853800	2700	White	30 yd.	17 oz.	78 in.
853824	2724	Yellow	30 yd.	17 oz.	78 in.

Use ONLY Trivantage® eradication solution for eradicating Eradi-Lite. DO NOT use any solvents to eradicate. Solvents will leave behind residual solvents that will harm the vinyl surface and cause premature yellowing when exposed to the elements. If solvents are used to eradicate, the warranty will be VOIDED.

Eradi-Lite® and Trivantage® are registered trademarks of Glen Raven, Inc.



Cooley-Brite®

Engineered for high color brilliance and translucency in back-lit signs or awnings. Cooley-Brite provides the fastest, most economical method of sign and awning decoration. Accommodates numerous other graphics applications, including pressure-sensitive vinyls, heat transfer, screen printing and spray painting. Highly durable and easily cleaned.

FABRIC	Extrusion Coated PVC
FINISH	Eradicable Ink Top Surface
FR STANDARDS MET	California State Fire Marshal, NFPA 701, UL Listed
WARRANTY	8-Year

ITEM #	STYLE #	COLOR	PUT UP	WEIGHT	WIDTH
853006	2025	Black	25 yd.	20 oz.	78 in.
853023	0132	Bright Red	25 yd.	20 oz.	78 in.
853005	2020	Burgundy	25 yd.	20 oz.	78 in.
853009	2114	Dark Blue	25 yd.	20 oz.	78 in.
853012	2283A	Dark Red	25 yd.	20 oz.	78 in.
853018	4048	Forest Green	25 yd.	20 oz.	78 in.
853008	2108A	Green	25 yd.	20 oz.	78 in.
853011	2146A	Ivory	25 yd.	20 oz.	78 in.
853013	2648	Light Blue	25 yd.	20 oz.	78 in.
853019	0355A	Light Green	25 yd.	20 oz.	78 in.
853014	2662A	Light Red	25 yd.	20 oz.	78 in.
853015	0301	Mid-Blue	25 yd.	20 oz.	78 in.
853010	2119A	Orange	25 yd.	20 oz.	78 in.
853017	0219A	Pink	25 yd.	20 oz.	78 in.
853021	0248	Plum	25 yd.	20 oz.	78 in.
853024	5025	Reflex Blue	25 yd.	20 oz.	78 in.
853022	0123A	Sunflower	25 yd.	20 oz.	78 in.
853016	5019	Teal	25 yd.	20 oz.	78 in.
853004	0606	White	25 yd.	20 oz.	78 in.
853201	SM-42	White	25 yd.	16 oz.	78 in.
853007	2037A	Yellow	25 yd.	20 oz.	78 in.

Cooley-Brite® and Cooley Magic® are registered trademarks of Cooley, Inc.

Cooley-Brite® II with Coolthane® EPS

All of the high color brilliance and unique graphics capabilities of Cooley-Brite are also available with a clear Coolthane® Enhanced Protection System top coating for extended life and easy cleaning. It's highly resistant to mildew and UV rays.

FABRIC	Extrusion Coated PVC
FINISH	Coolthane® EPS with Eradicable Ink Top Surface
FR STANDARDS MET	California State Fire Marshal, NFPA 701, UL Listed
WARRANTY	10-Year

ITEM #	STYLE #	COLOR	PUT UP	WEIGHT	WIDTH
853106	C2025	Black	25 yd.	20 oz.	78 in.
853123	C0132	Bright Red	25 yd.	20 oz.	78 in.
853105	C2020	Burgundy	25 yd.	20 oz.	78 in.
853109	C2114	Dark Blue	25 yd.	20 oz.	78 in.
853112	C2283A	Dark Red	25 yd.	20 oz.	78 in.
853118	C4048	Forest Green	25 yd.	20 oz.	78 in.
853108	C2108A	Green	25 yd.	20 oz.	78 in.
853111	C2146A	Ivory	25 yd.	20 oz.	78 in.
853113	C2648	Light Blue	25 yd.	20 oz.	78 in.
853119	C0355A	Light Green	25 yd.	20 oz.	78 in.
853114	C2662A	Light Red	25 yd.	20 oz.	78 in.
853115	C0301	Mid-Blue	25 yd.	20 oz.	78 in.
853140	79-7002	Night Shade Brown	50 yd.	20 oz.	78 in.
853110	C2119A	Orange	25 yd.	20 oz.	78 in.
853117	C0219A	Pink	25 yd.	20 oz.	78 in.
853121	C0248	Plum	25 yd.	20 oz.	78 in.
853124	C5025	Reflex Blue	25 yd.	20 oz.	78 in.
853141	79-2307	Startling Orange	50 yd.	20 oz.	78 in.
853122	C0123A	Sunflower	25 yd.	20 oz.	78 in.
853116	C5019	Teal	25 yd.	20 oz.	78 in.
853104	C0606	White	25 yd.	20 oz.	78 in.
853107	C2037A	Yellow	25 yd.	20 oz.	78 in.

Cooley-Brite® and Coolthane® are registered trademarks of Cooley, Inc.



Cooley-Brite® Lite

Flexible, yet durable, Cooley-Brite Lite is a lightweight, vinyl coated polyester fabric that features excellent translucency in any back-lit sign or awning application. This line of white and eradicable colored substrates is easy to handle and simple to install. Cooley-Brite Lite suits a wide range of graphic applications, including screen printing, pressure-sensitive graphics, and spray painting with acrylic-based paint. Its advanced scrim design enhances graphic effects to provide superior quality and luminescent colors. A more resilient ink surface helps prevent fabric bruising.

FABRIC	Extrusion Coated PVC
FINISH	Eradicable Ink Top Surface
FR STANDARDS MET	California State Fire Marshal, NFPA 701, UL Listed
WARRANTY	8-Year

ITEM #	STYLE #	COLOR	PUT UP	WEIGHT	WIDTH
853310	CBL10	Black	25 yd.	16 oz.	78 in.
853302	CBL2	Bright Red	25 yd.	16 oz.	78 in.
853322	CBL22	Burgundy	25 yd.	16 oz.	78 in.
853301	CBL1	Cherry Red	25 yd.	16 oz.	78 in.
853307	CBL7	Emerald Green	25 yd.	16 oz.	78 in.
853324	CBL21	Holly Green	25 yd.	16 oz.	78 in.
853316	CBL16	Intense Blue	25 yd.	16 oz.	78 in.
853304	CBL4	Lemon Yellow	25 yd.	16 oz.	78 in.
853305	CBL5	Navy Blue	25 yd.	16 oz.	78 in.
853315	CBL15	Petro Green	25 yd.	16 oz.	78 in.
853311	CBL11	Plum	25 yd.	16 oz.	78 in.
853319	CBL19	Raspberry	25 yd.	16 oz.	78 in.
853306	CBL6	Royal Blue	25 yd.	16 oz.	78 in.
853318	CBL18	Ruby Red	25 yd.	16 oz.	78 in.
853323	CBL20	Sunflower Yellow	25 yd.	16 oz.	78 in.
853317	CBL17	Tangerine	25 yd.	16 oz.	78 in.
853313	CBL13	Teal	25 yd.	16 oz.	78 in.
853300	CBL0606	White	25 yd.	16 oz.	78 in.
853320	CBL	White (no topcoat)	25 yd.	16 oz.	78 in.

Cooley-Brite® is a registered trademark of Cooley, Inc.

Eradicating Fluid

This non flammable eradicating fluid works instantly to remove the colored ink from a variety of back-lit fabrics to create brilliant white graphics on a solid color background. To facilitate design, computer generated can be used. This solution's gentle formula will not harm the substrate or the underlying scrim. It is easy to apply, easy to work with and clean up is simple. No mess, no fuss. The graphics stay bold because this fluid resists fading and yellowing. It combines with many other decorating techniques, giving you unlimited design possibilities.

ITEM #	STYLE #	PUT UP
214339	7299	1 gal.



Awning Composer®

A simple way to bring your vision to life

Instead of describing your customer's awning, show them. Take a picture of your customer's home or storefront then choose from over 40 dynamic objects, including corners. Once you've built your scene, add visual options to your awning; select fabric, a valance, text or graphics.

Let your customer see how an awning will impact their home or workplace by using our real-time shade simulation. Use their building location, time of year and direction to pin point exactly where their shade will be cast.

Awning Composer version 5 is built from the ground up, incorporating ideas and feedback from hundreds of fabrications. To learn more about what Awning Composer can do for you and to try the full version of the software for 15 days, visit awningcomposer.com

Additional Features

- Customize the shade structure or awning with different fabric patterns, valance styles, graphics and text.
- Scale backdrops using a known measurement from the building such as the height of a door.
- Dynamically generate entire 3D models, including both fabric and frame components.
- Take standard awning styles and make adjustments to the frame quickly.
- Create cutlists that can be color coded and numbered to match the frame.
- Quickly generate estimates for materials needed, materials cost, labor needed, and labor costs.
- Create custom multi-page printouts. Create layouts for sales visuals, production, estimation, and quoting.

Awning Composer Before & After



Dynamic Objects

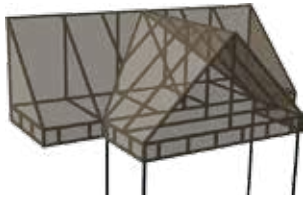

Start with standard combination style awnings and quickly customize spacing and add poles.



Easily create inside and outside corner awnings by adding awning segments together.

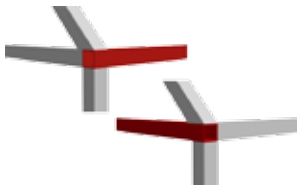

Set your preferences for master bars by using a drop down box to select master bar by location.



Add trussing by using a drop down box to select the type of truss needed.

Cut List

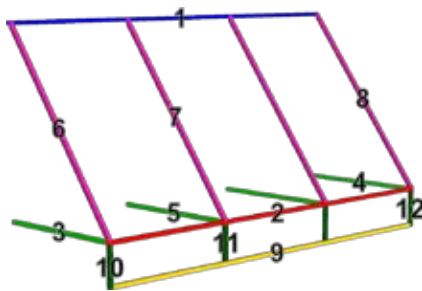

#	Name	Qty	Length	M1	M2
1	Open Traditional	1			
1	Top bar	1	9'		
2	Front bar	1	9'		
3	Left end out bar	1	2' 11"		
4	Right end out bar	1	2' 11"		
5	Intermediate out bar	2	2' 11"		
6	Left end rafter	1	4' 10 3/8"	53.4°	36.6°
7	Intermediate rafter	2	4' 10 3/8"	53.4°	36.6°
8	Right end rafter	1	4' 10 3/8"	53.4°	36.6°
9	SB front bar	1	8' 10"		
10	SB front left support	1	10"		
11	SB front support	2	9"		
12	SB front right support	1	10"		
	TOTAL	15	61' 2 3/8"		
	LENGTHS	3			

Estimation Add-on (Sold Separately)

Awning Composer's Estimation add-on brings new functionality to Awning Composer by adding the ability to estimate the amount of materials, labor time, cost of production, and retail price. Working directly with your live rendering, estimation results are updated continuously as you build and customize awnings in the 3D view.

Estimation Features:

- Extensive estimation support for 20+ dynamic awning styles plus associated corners
- An instant default quote layout
- Ability to quote more than one dynamic object in the same scene
- New printing features including the ability to build multi-page layouts

For more information or a full 15-day trial of Awning Composer's Estimation Add-on, visit www.awningcomposer.com

QUOTE

More Shade, LLC
112 North Park Ave.
Burlington, NC 27217
Phone: 888-555-1212
Fax: 800-555-1212
Email: info@moreshade.com

Quote date: 7/8/2016
Quote number: 2016-03-109
Expiration date: 5/1/2016

Customer name: Joe Smith
Street address 1: 1234 Main Street
Street address 2:
City, State, Zip: Burlington, NC 27217
Phone: 336-555-1212
Cell:
Fax:
Email:

Salesperson	Job Description	Payment Terms	Due Date
Bob Jones	Main St. Awning	50% deposit, balance on installation	7/15/2016

Qty	Style	Description	Price
1	Open Traditional	Open Traditional awning with frame and fabric Dimensions: 7' 6"(W) x 5'(H) x 3' 9"(D) Sign band height: 6" Options: spreader bar, vertical top fabric, sign band joined with top fabric	\$901.94

Total price	\$901.94
Sales tax (9%)	\$81.17
Total installed price	\$983.11

Shade Sails and Awnings
Since 1981



ITEM #	STYLE #	COLOR	PUT UP	WEIGHT	WIDTH
740254	45789-0000	Bingham Graphite	40-60 yd.	13.3 oz.	54 in.
740255	45789-0001	Bingham Lagoon	40-60 yd.	13.3 oz.	54 in.
740904	45893-0006	Boss Tweede II Celadon	40-60 yd.	12 oz.	54 in.
740910	45893-0025	Boss Tweede II Char	40-60 yd.	12 oz.	54 in.
740906	45893-0010	Boss Tweede II Chili	40-60 yd.	12 oz.	54 in.
740907	45893-0011	Boss Tweede II Denim	40-60 yd.	12 oz.	54 in.
740908	45893-0012	Boss Tweede II Indigo	40-60 yd.	12 oz.	54 in.
740905	45893-0008	Boss Tweede II Mink	40-60 yd.	12 oz.	54 in.
740902	45893-0004	Boss Tweede II Pebble	40-60 yd.	12 oz.	54 in.
740901	45893-0003	Boss Tweede II Salt	40-60 yd.	12 oz.	54 in.
740909	45893-0024	Boss Tweede II Stone	40-60 yd.	12 oz.	54 in.
740900	45893-0001	Boss Tweede II Storm	40-60 yd.	12 oz.	54 in.
740903	45893-0005	Boss Tweede II Wren	40-60 yd.	12 oz.	54 in.
740839	40107-0019	Bubble Mariner	40-60 yd.	9.3 oz.	54 in.
740882	44296-0001	Chapman Char	40-60 yd.	8.8 oz.	54 in.
740886	44296-0005	Chapman Juniper	40-60 yd.	8.8 oz.	54 in.
740885	44296-0004	Chapman Prep	40-60 yd.	8.8 oz.	54 in.
740884	44296-0003	Chapman Rust	40-60 yd.	8.8 oz.	54 in.
740883	44296-0002	Chapman Shadow	40-60 yd.	8.8 oz.	54 in.
729356	45864-0002	Chartres Barley	40-60 yd.	12 oz.	54 in.
740895	45864-0049	Chartres Fawn	40-60 yd.	12 oz.	54 in.
740042	45864-0001	Chartres Flax	40-60 yd.	12 oz.	54 in.
740911	45864-0050	Chartres Graphite	40-60 yd.	12 oz.	54 in.
740041	45864-0000	Chartres Hemp	40-60 yd.	12 oz.	54 in.
740894	45864-0048	Chartres Malt	40-60 yd.	12 oz.	54 in.
740047	45864-0045	Chartres Mist	40-60 yd.	12 oz.	54 in.
740045	45864-0004	Chartres Pebble	40-60 yd.	12 oz.	54 in.
740893	45864-0019	Chartres Salt	40-60 yd.	12 oz.	54 in.
740896	45864-0051	Chartres Storm	40-60 yd.	12 oz.	54 in.
740044	45864-0003	Chartres Willow	40-60 yd.	12 oz.	54 in.
740046	45864-0014	Chartres Wisteria	40-60 yd.	12 oz.	54 in.
740819	145153-0004	Connection Guava	40-60 yd.	14.5 oz.	54 in.
740818	145153-0000	Connection Onyx	40-60 yd.	14.5 oz.	54 in.
740820	145153-0005	Connection Sand	40-60 yd.	14.5 oz.	54 in.
740048	45973-0001	Crazy Quilt Seaglass	40-60 yd.	12.8 oz.	54 in.
740881	44282-0020	Demo Cloud	40-60 yd.	7.8 oz.	54 in.
740880	44282-0018	Demo Denim	40-60 yd.	7.8 oz.	54 in.
740872	44282-0003	Demo Fog	40-60 yd.	7.8 oz.	54 in.
740874	44282-0005	Demo Graphite	40-60 yd.	7.8 oz.	54 in.
740879	44282-0017	Demo Indigo	40-60 yd.	7.8 oz.	54 in.
740878	44282-0011	Demo Jade	40-60 yd.	7.8 oz.	54 in.
740870	44282-0001	Demo Parchment	40-60 yd.	7.8 oz.	54 in.
740871	44282-0002	Demo Putty	40-60 yd.	7.8 oz.	54 in.
740869	44282-0000	Demo Salt	40-60 yd.	7.8 oz.	54 in.
740876	44282-0008	Demo Sparrow	40-60 yd.	7.8 oz.	54 in.
740873	44282-0004	Demo Stone	40-60 yd.	7.8 oz.	54 in.
740875	44282-0007	Demo Stucco	40-60 yd.	7.8 oz.	54 in.
740877	44282-0009	Demo Wren	40-60 yd.	7.8 oz.	54 in.
740842	40441-0005	Dip Dye Aloe	40-60 yd.	8.5 oz.	54 in.
740841	40441-0001	Dip Dye Chickadee	40-60 yd.	8.5 oz.	54 in.
740040	45345-0000	Extend Breeze	40-60 yd.	12 oz.	54 in.

Sunbrella® 2017-2019 Fusion Collection

Sunbrella Fusion is a highly decorative collection of upholstery fabrics available exclusively through Trivantage®. The line is the fusion of beauty and durability, with gorgeous fabrics for indoor and outdoor use that allows for a worry-free lifestyle. The Fusion collection offers a wide variety of colors and patterns, including both classic basics and show-stopping jacquards for the ultimate in style and design possibilities.

FABRIC	Sunbrella Acrylic
FINISH	Soil, Stain and Water Repellent Finish
FR STANDARDS MET	California Technical Bulletin 117-2013 Class 1
WARRANTY	5-Year

ITEM #	STYLE #	COLOR	PUT UP	WEIGHT	WIDTH
740887	44297-0001	Abbott Char	40-60 yd.	8.8 oz.	54 in.
740891	44297-0005	Abbott Juniper	40-60 yd.	8.8 oz.	54 in.
740890	44297-0004	Abbott Prep	40-60 yd.	8.8 oz.	54 in.
740889	44297-0003	Abbott Rust	40-60 yd.	8.8 oz.	54 in.
740888	44297-0002	Abbott Shadow	40-60 yd.	8.8 oz.	54 in.
740817	145147-0005	Agra Classic	40-60 yd.	11.5 oz.	54 in.
740815	145147-0000	Agra Indigo	40-60 yd.	11.5 oz.	54 in.
740816	145147-0002	Agra Pebble	40-60 yd.	11.5 oz.	54 in.
729545	1357-0001	Beachcomber Dune	40-60 yd.	14.1 oz.	54 in.
740811	145098-0003	Bevel Smoke	40-60 yd.	11.5 oz.	54 in.

ITEM #	STYLE #	COLOR	PUT UP	WEIGHT	WIDTH
740827	40014-0149	Flagship Alpaca	40-60 yd.	7.7 oz.	54 in.
740831	40014-0153	Flagship Cilantro	40-60 yd.	7.7 oz.	54 in.
740823	40014-0101	Flagship Eclipse	40-60 yd.	7.7 oz.	54 in.
740824	40014-0146	Flagship Flax	40-60 yd.	7.7 oz.	54 in.
740838	40014-0160	Flagship Guava	40-60 yd.	7.7 oz.	54 in.
740828	40014-0150	Flagship Hedge	40-60 yd.	7.7 oz.	54 in.
740826	40014-0148	Flagship Hemp	40-60 yd.	7.7 oz.	54 in.
740832	40014-0154	Flagship Ivy	40-60 yd.	7.7 oz.	54 in.
740495	40014-0005	Flagship Pecan	40-60 yd.	7.7 oz.	54 in.
740014	40014-0039	Flagship Persimmon	40-60 yd.	7.7 oz.	54 in.
740829	40014-0151	Flagship Pewter	40-60 yd.	7.7 oz.	54 in.
740833	40014-0155	Flagship Reef	40-60 yd.	7.7 oz.	54 in.
740836	40014-0158	Flagship Rosewood	40-60 yd.	7.7 oz.	54 in.
740837	40014-0159	Flagship Rouge	40-60 yd.	7.7 oz.	54 in.
740830	40014-0152	Flagship Sage	40-60 yd.	7.7 oz.	54 in.
740015	40014-0065	Flagship Salt	40-60 yd.	7.7 oz.	54 in.
740825	40014-0147	Flagship Silver	40-60 yd.	7.7 oz.	54 in.
740834	40014-0156	Flagship Tide	40-60 yd.	7.7 oz.	54 in.
740835	40014-0157	Flagship Twilight	40-60 yd.	7.7 oz.	54 in.
740490	40014-0000	Flagship Vellum	40-60 yd.	7.7 oz.	54 in.
740565	40308-0001	Hampton Indigo	40-60 yd.	8.3 oz.	54 in.
740840	40308-0004	Hampton Stone	40-60 yd.	8.3 oz.	54 in.
740061	44240-0001	Houndstooth Ivory	40-60 yd.	9.9 oz.	54 in.
740063	44240-0004	Houndstooth Spark	40-60 yd.	9.9 oz.	54 in.
740062	44240-0003	Houndstooth Wren	40-60 yd.	9.9 oz.	54 in.
740661	45412-0001	Lanai Lagoon	40-60 yd.	12 oz.	54 in.
740822	145239-0000	Maritime Nautical	40-60 yd.	16.5 oz.	54 in.
740037	44216-0011	Meander Lilac	40-60 yd.	12.6 oz.	54 in.
740038	44216-0012	Meander Pebble	40-60 yd.	12.6 oz.	54 in.
740036	44216-0005	Meander Shamrock	40-60 yd.	12.6 oz.	54 in.
740039	44216-0013	Meander Wren	40-60 yd.	12.6 oz.	54 in.
740616	40061-0016	Meridian Air	40-60 yd.	7.1 oz.	54 in.
740059	40061-0059	Meridian Cameo	40-60 yd.	7.1 oz.	54 in.
740634	40061-0034	Meridian Charcoal	40-60 yd.	7.1 oz.	54 in.
740608	40061-0008	Meridian Coco	40-60 yd.	7.1 oz.	54 in.
740053	40061-0053	Meridian Flax	40-60 yd.	7.1 oz.	54 in.
740060	40061-0060	Meridian Grain	40-60 yd.	7.1 oz.	54 in.
740057	40061-0057	Meridian Meadow	40-60 yd.	7.1 oz.	54 in.
740056	40061-0056	Meridian Mist	40-60 yd.	7.1 oz.	54 in.
740054	40061-0054	Meridian Pewter	40-60 yd.	7.1 oz.	54 in.
740058	40061-0058	Meridian Rose	40-60 yd.	7.1 oz.	54 in.
740614	40061-0014	Meridian Twilight	40-60 yd.	7.1 oz.	54 in.
740055	40061-0055	Meridian Wisteria	40-60 yd.	7.1 oz.	54 in.
740607	40061-0007	Meridian Wren	40-60 yd.	7.1 oz.	54 in.
740810	1354-0006	Navigation Mariner	40-60 yd.	12.6 oz.	54 in.
740049	45984-0000	Paris Blush	40-60 yd.	12 oz.	54 in.
740051	45984-0004	Paris Lavender	40-60 yd.	12 oz.	54 in.
740052	45984-0005	Paris Mist	40-60 yd.	12 oz.	54 in.
740050	45984-0001	Paris Raffia	40-60 yd.	12 oz.	54 in.

ITEM #	STYLE #	COLOR	PUT UP	WEIGHT	WIDTH
740860	44157-0017	Posh Aqua	40-60 yd.	12.6 oz.	54 in.
740031	44157-0013	Posh Ash	40-60 yd.	12.6 oz.	54 in.
740033	44157-0021	Posh Charcoal	40-60 yd.	12.6 oz.	54 in.
740859	44157-0016	Posh Coral	40-60 yd.	12.6 oz.	54 in.
740034	44157-0023	Posh Dove	40-60 yd.	12.6 oz.	54 in.
740858	44157-0014	Posh Lichen	40-60 yd.	12.6 oz.	54 in.
740021	44157-0002	Posh Lime	40-60 yd.	12.6 oz.	54 in.
740022	44157-0004	Posh Oat	40-60 yd.	12.6 oz.	54 in.
740019	44157-0000	Posh Parchment	40-60 yd.	12.6 oz.	54 in.
740032	44157-0018	Posh Salt	40-60 yd.	12.6 oz.	54 in.
740861	44157-0019	Posh Shamrock	40-60 yd.	12.6 oz.	54 in.
740035	44157-0024	Posh Shitake	40-60 yd.	12.6 oz.	54 in.
740234	42034-0004	Reel Parchment	40-60 yd.	10.5 oz.	54 in.
740230	42034-0000	Reel Slate	40-60 yd.	10.5 oz.	54 in.
740812	145114-0000	Rialto Ash	40-60 yd.	11.3 oz.	54 in.
740813	145114-0001	Rialto Mist	40-60 yd.	11.3 oz.	54 in.
740814	145114-0002	Rialto Moss	40-60 yd.	11.3 oz.	54 in.
740862	44193-0000	Rochelle Bleu	40-60 yd.	8.8 oz.	54 in.
740864	44193-0002	Rochelle Parchment	40-60 yd.	8.8 oz.	54 in.
740867	44193-0021	Rochelle Pebble	40-60 yd.	8.5 oz.	54 in.
740868	44193-0022	Rochelle Slate	40-60 yd.	8.5 oz.	54 in.
740863	44193-0001	Rochelle Spice	40-60 yd.	8.8 oz.	54 in.
740865	44193-0005	Rochelle Toffee	40-60 yd.	8.8 oz.	54 in.
740866	44193-0013	Rochelle White	40-60 yd.	8.8 oz.	54 in.
740897	45889-0007	Savvy Indigo	40-60 yd.	11.5 oz.	54 in.
740898	45889-0009	Savvy Onyx	40-60 yd.	11.5 oz.	54 in.
740899	45889-0010	Savvy Sangria	40-60 yd.	11.5 oz.	54 in.
740844	40465-0004	Scope Cape	40-60 yd.	7.5 oz.	54 in.
740845	40465-0005	Scope Foliage	40-60 yd.	7.5 oz.	54 in.
740843	40465-0000	Scope Vintage	40-60 yd.	7.5 oz.	54 in.
740854	42082-0011	Tailored Cherry	40-60 yd.	11.3 oz.	54 in.
740850	42082-0005	Tailored Coal	40-60 yd.	11.3 oz.	54 in.
740848	42082-0002	Tailored Fog	40-60 yd.	11.3 oz.	54 in.
740857	42082-0017	Tailored Indigo	40-60 yd.	11.3 oz.	54 in.
740856	42082-0016	Tailored Lagoon	40-60 yd.	11.3 oz.	54 in.
740851	42082-0006	Tailored Mink	40-60 yd.	11.3 oz.	54 in.
740847	42082-0001	Tailored Putty	40-60 yd.	11.3 oz.	54 in.
740849	42082-0004	Tailored Smoke	40-60 yd.	11.3 oz.	54 in.
740846	42082-0000	Tailored Snow	40-60 yd.	11.3 oz.	54 in.
740852	42082-0007	Tailored Taupe	40-60 yd.	11.3 oz.	54 in.
740855	42082-0013	Tailored Wisteria	40-60 yd.	11.3 oz.	54 in.
740853	42082-0009	Tailored Wren	40-60 yd.	11.3 oz.	54 in.
740821	145214-0000	Tropics Jungle	40-60 yd.	13.3 oz.	54 in.
741177	40332-0005	Viento Mercury	40-60 yd.	7.5 oz.	54 in.
741178	40332-0006	Viento Nautical	40-60 yd.	7.5 oz.	54 in.
741179	40332-0008	Viento Paprika	40-60 yd.	7.5 oz.	54 in.
741180	47072-0004	Zara Moroccan	40-60 yd.	14.9 oz.	54 in.

Sunbrella® is a registered trademark of Glen Raven, Inc. Trivantage® is a registered trademark of Glen Raven, Inc.



Sunbrella® Twist Cord-Edge

Twisted bead is constructed from Sunbrella yarns. Color-matched sewing tab. Can be used as a welting on marine and patio cushions or as a decorative umbrella trimming. Colors and blends are specifically selected to complement our Fusion Collection as well as the Sunbrella Upholstery Collection.

3 yard minimum for cut yardage.

ITEM #	STYLE #	COLOR	PUT UP	WIDTH
504706	07313-4633	Almond	25 yd.	3/8 in.
504720	07313-5416	Aruba	25 yd.	3/8 in.
504729	08337	Barley	25 yd.	3/8 in.
504707	07313-4635	Buttercup	25 yd.	3/8 in.
504714	07313-4675	Capri	25 yd.	3/8 in.
504703	07313-4621	Chocolate	25 yd.	3/8 in.
504715	07313-4676	Cocoa	25 yd.	3/8 in.
504700	07313-4603	Crimson	25 yd.	3/8 in.
504721	07313-5418	Deep Sea	25 yd.	3/8 in.
504705	07313-4630	Dove	25 yd.	3/8 in.
504732	08347-CE	Dune	25 yd.	3/8 in.
504733	08348-CE	Flame	25 yd.	3/8 in.
504717	07313-4685	Ginkgo	25 yd.	3/8 in.
504724	07313-5441	Gold	25 yd.	3/8 in.
504708	07313-4644	Graphite	25 yd.	3/8 in.
504725	07313-5462	Hot Pink	25 yd.	3/8 in.
504734	08349	Linden	25 yd.	3/8 in.
504719	07313-5415	Melon	25 yd.	3/8 in.
504728	07532-CE	Nautical	25 yd.	3/8 in.
504704	07313-4626	Navy	25 yd.	3/8 in.
504718	07313-4686	Nutmeg	25 yd.	3/8 in.
504702	07313-4608	Onyx	25 yd.	3/8 in.
504723	07313-5421	Palm	25 yd.	3/8 in.
504710	07313-4649	Plum	25 yd.	3/8 in.
504730	08345	Putty	25 yd.	3/8 in.
504701	07313-4604	Salt	25 yd.	3/8 in.
504722	07313-5420	Sky	25 yd.	3/8 in.
504731	08346	Smoke	25 yd.	3/8 in.
504712	07313-4673	Spa	25 yd.	3/8 in.
504709	07313-4648	Stone	25 yd.	3/8 in.
504726	07313-5488	Teak	25 yd.	3/8 in.
504716	07313-4677	Tuscan	25 yd.	3/8 in.
504727	07313-5498	Vellum	25 yd.	3/8 in.
504713	07313-4674	Wheat	25 yd.	3/8 in.
504711	07313-4672	Wren	25 yd.	3/8 in.

Sunbrella® is a registered trademark of Glen Raven, Inc.

Sunbrella® Brush Fringe

Brush fringe is constructed from Sunbrella yarns. Can be used for marine and patio throw pillows, or as a decorative umbrella trimming. Colors and blends are specifically selected to complement our Fusion Collection as well as the Sunbrella Upholstery Collection.

3 yard minimum for cut yardage.

ITEM #	STYLE #	COLOR	PUT UP	WIDTH
504507	08337-2	Barley	25 yd.	2 in.
503768	07104	Black/Charcoal/Toast	25 yd.	3 in.
504502	07300-4635	Buttercup	25 yd.	2 in.
504504	07697-2	Classic	25 yd.	2 in.
504515	08354-2	Clay	25 yd.	2 in.
503874	07300	Cocoa	25 yd.	2 in.
504510	08347-2	Dune	25 yd.	2 in.
504516	08359-2	Dusk	25 yd.	2 in.
504511	08348-2	Flame	25 yd.	2 in.
504503	07300-5462	Hot Pink	25 yd.	2 in.
504513	08351-2	Indigo	25 yd.	2 in.
503856	06867	Jockey Red	25 yd.	2 in.
503657	06917	Linen/Linen Boucle	25 yd.	2 in.
504517	08362-2	Meadow	25 yd.	2 in.
503855	06865	Natural	25 yd.	2 in.
504501	07300-4608	Onyx	25 yd.	2 in.
504514	08352-2	Opal	25 yd.	2 in.
504505	08290-2	Papaya	25 yd.	2 in.
504508	08345-2	Putty	25 yd.	2 in.
504506	08293-2	Rain Forest	25 yd.	2 in.
504512	08350-2	Redwood	25 yd.	2 in.
504500	07300-4604	Salt	25 yd.	2 in.
504509	08346-2	Smoke	25 yd.	2 in.

Sunbrella® is a registered trademark of Glen Raven, Inc.



Sunbrella® 2016-2017 Shift Collection

The Shift Collection features classic design interpreted in a contemporary fashion, fusing traditional pattern with modern styling. Fabrics are designed to be mixed and matched by layering texture, color and pattern, creating an eclectic familiar-meets-new mood.

FABRIC	Sunbrella Acrylic, PVC, Polyester
FINISH	Soil, Stain and Water Repellent Finish
FR STANDARDS MET	California Technical Bulletin 117-2013 Class 1
WARRANTY	5-Year

ITEM #	STYLE #	COLOR	PUT UP	WEIGHT	WIDTH
743750	58043-0000	Connect Cosmic	30-60 yd.	7.8 oz.	54 in.
743751	58042-0000	Connect Dune	30-60 yd.	7.8 oz.	54 in.
743752	58041-0000	Connect Fusion	30-60 yd.	7.8 oz.	54 in.
743753	58044-0000	Connect Twilight	30-60 yd.	7.8 oz.	54 in.
743754	57010-0000	Escapade Electro	30-60 yd.	12.5 oz.	54 in.
743755	57009-0000	Escapade Fusion	30-60 yd.	12.5 oz.	54 in.
743756	57008-0000	Escapade Twilight	30-60 yd.	12.5 oz.	54 in.
743757	57011-0000	Escapade Vivid	30-60 yd.	12.5 oz.	54 in.
743758	69006-0007	Integrated Dune	30-60 yd.	17.3 oz.	54 in.
743759	69006-0009	Integrated Indigo	30-60 yd.	17.3 oz.	54 in.
743760	69006-0006	Integrated Pewter	30-60 yd.	17.3 oz.	54 in.
743761	69006-0008	Integrated Steel	30-60 yd.	17.3 oz.	54 in.
743762	46058-0013	Loft Char	30-60 yd.	11 oz.	54 in.
743763	46058-0009	Loft Crimson	30-60 yd.	11 oz.	54 in.
743764	46058-0007	Loft Dune	30-60 yd.	11 oz.	54 in.
743765	46058-0004	Loft Flax	30-60 yd.	11 oz.	54 in.

ITEM #	STYLE #	COLOR	PUT UP	WEIGHT	WIDTH
743766	46058-0010	Loft Grape	30-60 yd.	11 oz.	54 in.
743767	46058-0006	Loft Grey	30-60 yd.	11 oz.	54 in.
743768	46058-0012	Loft Indigo	30-60 yd.	11 oz.	54 in.
743769	46058-0005	Loft Pebble	30-60 yd.	11 oz.	54 in.
743770	46058-0011	Loft Turquoise	30-60 yd.	11 oz.	54 in.
743771	46058-0003	Loft White	30-60 yd.	11 oz.	54 in.
743772	46058-0008	Loft Wisteria	30-60 yd.	11 oz.	54 in.
743773	69008-0001	Radiant Dune	30-60 yd.	15.3 oz.	54 in.
743774	69008-0005	Radiant Kiwi	30-60 yd.	15.3 oz.	54 in.
743775	69008-0003	Radiant Lagoon	30-60 yd.	15.3 oz.	54 in.
743776	69008-0004	Radiant Sangria	30-60 yd.	15.3 oz.	54 in.
743777	69008-0000	Radiant Silver	30-60 yd.	15.3 oz.	54 in.
743778	69008-0002	Radiant Slate	30-60 yd.	15.3 oz.	54 in.
743779	15000-0003	Spotlight Ash	30-60 yd.	11 oz.	54 in.
743780	15000-0009	Spotlight Azure	30-60 yd.	11 oz.	54 in.
743781	15000-0008	Spotlight Citron	30-60 yd.	11 oz.	54 in.
743782	15000-0001	Spotlight Dune	30-60 yd.	11 oz.	54 in.
743783	15000-0004	Spotlight Emerald	30-60 yd.	11 oz.	54 in.
743784	15000-0010	Spotlight Flame	30-60 yd.	11 oz.	54 in.
743785	15000-0006	Spotlight Galaxy	30-60 yd.	11 oz.	54 in.
743786	15000-0007	Spotlight Indigo	30-60 yd.	11 oz.	54 in.
743787	15000-0005	Spotlight Lagoon	30-60 yd.	11 oz.	54 in.
743788	15000-0002	Spotlight Pebble	30-60 yd.	11 oz.	54 in.
743789	15000-0011	Spotlight Rose	30-60 yd.	11 oz.	54 in.
743790	15000-0012	Spotlight Wisteria	30-60 yd.	11 oz.	54 in.

Sunbrella® is a registered trademark of Glen Raven, Inc.



Sunbrella® 2016-2017 Upholstery Collection – Decorative

Sunbrella upholstery fabrics make any space look stunning, with the strength to stand up to the elements and everyday use. Perfect for both indoor and outdoor applications, Sunbrella upholstery is water repellent, bleach cleanable and fade resistant, yet incredibly soft to the touch.

With a large selection of solids, patterns, textures and jacquards, the possibilities are endless. Coordinate upholstery fabric with awnings, umbrellas, drapery, and more.

FABRIC	Sunbrella Acrylic
FINISH	Soil, Stain and Water Repellent Finish
FR STANDARDS MET	California Technical Bulletin 117-2013 Class 1
WARRANTY	5-Year

ITEM #	STYLE #	COLOR	PUT UP	WEIGHT	WIDTH
743656	45936-0000	Accord II Crimson	40-60 yd.	12.8 oz.	54 in.
743652	45922-0000	Accord Jade	40-60 yd.	14 oz.	54 in.
743653	45922-0001	Accord Koi	40-60 yd.	14 oz.	54 in.
735381	44285-0001	Action Ash	40-60 yd.	9.8 oz.	54 in.
735384	44285-0004	Action Denim	40-60 yd.	9.8 oz.	54 in.
735380	44285-0000	Action Linen	40-60 yd.	9.8 oz.	54 in.
735382	44285-0002	Action Stone	40-60 yd.	9.8 oz.	54 in.
735383	44285-0003	Action Taupe	40-60 yd.	9.8 oz.	54 in.
743666	56096-0000	Astoria Lagoon	40-60 yd.	8.3 oz.	54 in.
743665	56095-0000	Astoria Sunset	40-60 yd.	8.3 oz.	54 in.
729287	45707-0002	Aura Honey	40-60 yd.	14.5 oz.	54 in.
738521	8521-0000	Berenson Tuxedo	40-60 yd.	9.1 oz.	54 in.
729290	7253-0000	Bessemer 1000BA	40-60 yd.	10.3 oz.	54 in.
729219	45542-0000	Blox Slate	40-60 yd.	12 oz.	54 in.
735712	5612-0000	Brannon Redwood	40-60 yd.	8.3 oz.	54 in.
735610	5621-0000	Brannon Whisper	40-60 yd.	8.3 oz.	54 in.
735602	5602-0000	Bravada Limelite	40-60 yd.	8.3 oz.	54 in.
735701	5601-0000	Bravada Salsa	40-60 yd.	8.3 oz.	54 in.
743719	58026-0000	Cabana Citron	40-60 yd.	8.3 oz.	54 in.
743723	58030-0000	Cabana Classic	40-60 yd.	8.3 oz.	54 in.
743720	58027-0000	Cabana Emerald	40-60 yd.	8.3 oz.	54 in.
743721	58028-0000	Cabana Flame	40-60 yd.	8.3 oz.	54 in.
743722	58029-0000	Cabana Regatta	40-60 yd.	8.3 oz.	54 in.
729299	45099-0003	Cabaret Blue Haze	40-60 yd.	10.6 oz.	54 in.
743700	40428-0000	Cast Ash	40-60 yd.	7.1 oz.	54 in.
735379	40456-0000	Cast Lagoon	40-60 yd.	7.1 oz.	54 in.
743701	40429-0000	Cast Mist	40-60 yd.	7.1 oz.	54 in.
743702	40430-0000	Cast Oasis	40-60 yd.	7.1 oz.	54 in.
743703	40431-0000	Cast Petal	40-60 yd.	7.1 oz.	54 in.
743704	40432-0000	Cast Shale	40-60 yd.	7.1 oz.	54 in.
743705	40433-0000	Cast Silver	40-60 yd.	7.1 oz.	54 in.
743706	40434-0000	Cast Slate	40-60 yd.	7.1 oz.	54 in.
743707	40435-0000	Cast Tinsel	40-60 yd.	7.1 oz.	54 in.
743730	58037-0000	Cove Cameo	40-60 yd.	8.3 oz.	54 in.
743729	58036-0000	Cove Pebble	40-60 yd.	8.3 oz.	54 in.
735706	5606-0000	Davidson Redwood	40-60 yd.	8.6 oz.	54 in.

ITEM #	STYLE #	COLOR	PUT UP	WEIGHT	WIDTH
738631	8031-0000	Dimone Sequoia	40-60 yd.	10.1 oz.	54 in.
746000	56000-0000	Dolce Mango	40-60 yd.	8.3 oz.	54 in.
746001	56001-0000	Dolce Oasis	40-60 yd.	8.3 oz.	54 in.
746059	56059-0000	Dorsett Cherry	40-60 yd.	8.3 oz.	54 in.
743717	57005-0000	Echo Ash	40-60 yd.	10.1 oz.	54 in.
743689	8079-0000	Echo Citron	40-60 yd.	10.1 oz.	54 in.
743718	57007-0000	Echo Dune	40-60 yd.	10.1 oz.	54 in.
743688	8078-0000	Echo Limelite	40-60 yd.	10.1 oz.	54 in.
743686	8076-0000	Echo Midnight	40-60 yd.	10.1 oz.	54 in.
743690	8080-0000	Echo Sangria	40-60 yd.	10.1 oz.	54 in.
743687	8077-0000	Echo Teak	40-60 yd.	10.1 oz.	54 in.
729289	45746-0001	Elegance Marble	40-60 yd.	14.4 oz.	54 in.
743637	45837-0002	Empire Dove	40-60 yd.	14.5 oz.	54 in.
743644	45885-0004	Fischer Graphite	40-60 yd.	14.5 oz.	54 in.
743640	45885-0000	Fischer Lagoon	40-60 yd.	14.5 oz.	54 in.
743641	45885-0001	Fischer Sunset	40-60 yd.	14.5 oz.	54 in.
729228	56051-0000	Foster Metallic	40-60 yd.	8.3 oz.	54 in.
729226	56049-0000	Foster Surfside	40-60 yd.	8.3 oz.	54 in.
743662	56092-0000	Frequency Ash	40-60 yd.	8.3 oz.	54 in.
743663	56093-0000	Frequency Parchment	40-60 yd.	8.3 oz.	54 in.
743664	56094-0000	Frequency Sand	40-60 yd.	8.3 oz.	54 in.
743714	45991-0003	Fretwork Cameo	40-60 yd.	12 oz.	54 in.
740717	45991-0001	Fretwork Flax	40-60 yd.	12 oz.	54 in.
743712	45991-0000	Fretwork Mist	40-60 yd.	12 oz.	54 in.
743713	45991-0002	Fretwork Pewter	40-60 yd.	12 oz.	54 in.
743731	58038-0000	Gateway Blush	40-60 yd.	8.3 oz.	54 in.
743732	58039-0000	Gateway Mist	40-60 yd.	8.3 oz.	54 in.
729229	56052-0000	Gavin Mist	40-60 yd.	8.3 oz.	54 in.
735603	5603-0000	Harwood Crimson	40-60 yd.	8.6 oz.	54 in.
743708	42076-0000	Hybrid Citrus	40-60 yd.	11.6 oz.	54 in.
743709	42077-0000	Hybrid Lime	40-60 yd.	11.6 oz.	54 in.
743710	42078-0000	Hybrid Sky	40-60 yd.	11.6 oz.	54 in.
743711	42079-0000	Hybrid Smoke	40-60 yd.	11.6 oz.	54 in.
743674	57004-0000	Lido Indigo	40-60 yd.	8.6 oz.	54 in.
729282	45690-0000	Luxe Indigo	40-60 yd.	12.9 oz.	54 in.
729213	42048-0009	Mainstreet Latte	40-60 yd.	12.5 oz.	54 in.
729212	42048-0005	Mainstreet Wren	40-60 yd.	12.5 oz.	54 in.
735630	5630-0000	Mason Forest Green	40-60 yd.	8.3 oz.	54 in.
746079	56079-0000	Milano Char	40-60 yd.	8.3 oz.	54 in.
746080	56080-0000	Milano Cobalt	40-60 yd.	8.3 oz.	54 in.
746087	56087-0000	Milano Dawn	40-60 yd.	8.3 oz.	54 in.
746081	56081-0000	Milano Flax	40-60 yd.	8.3 oz.	54 in.
729202	56071-0000	Passage Poppy	40-60 yd.	8.3 oz.	54 in.
746075	56075-0000	Peyton Granite	40-60 yd.	8.6 oz.	54 in.
743693	145094-0000	Reflex Classic	40-60 yd.	10.8 oz.	54 in.
743696	145094-0003	Reflex Emerald	40-60 yd.	10.8 oz.	54 in.
743695	145094-0002	Reflex Flame	40-60 yd.	10.8 oz.	54 in.
743697	145095-0000	Reflex II Citron	40-60 yd.	11.6 oz.	54 in.
743694	145094-0001	Reflex Regatta	40-60 yd.	10.8 oz.	54 in.
735695	5695-0000	Regency Sand	40-60 yd.	8.6 oz.	54 in.
735708	5608-0000	Seville Seaside	40-60 yd.	8.3 oz.	54 in.

ITEM #	STYLE #	COLOR	PUT UP	WEIGHT	WIDTH
743727	58034-0000	Shore Citron	40-60 yd.	8.3 oz.	54 in.
743726	58033-0000	Shore Classic	40-60 yd.	8.3 oz.	54 in.
743728	58035-0000	Shore Emerald	40-60 yd.	8.3 oz.	54 in.
743724	58031-0000	Shore Flame	40-60 yd.	8.3 oz.	54 in.
743725	58032-0000	Shore Regatta	40-60 yd.	8.3 oz.	54 in.
743228	32008-0000	Solana Seagull	40-60 yd.	13.9 oz.	54 in.
743668	56098-0000	Solano Fiesta	40-60 yd.	10.1 oz.	54 in.
743683	58003-0000	Stanton Brownstone	40-60 yd.	8.3 oz.	54 in.
743682	58002-0000	Stanton Greystone	40-60 yd.	8.3 oz.	54 in.
743681	58001-0000	Stanton Lagoon	40-60 yd.	8.3 oz.	54 in.
743716	56099-0000	Token Caribbean	40-60 yd.	10.1 oz.	54 in.
743733	58040-0000	Token Surfside	40-60 yd.	10.1 oz.	54 in.
729240	45760-0002	Violetta Baltic	40-60 yd.	14.5 oz.	54 in.

Sunbrella® is a registered trademark of Glen Raven, Inc.

Sunbrella® 2016-2017 Upholstery Collection – Canvas

Sunbrella upholstery fabrics make any space look stunning, with the strength to stand up to the elements and everyday use. Perfect for both indoor and outdoor applications, Sunbrella upholstery is water repellent, bleach cleanable and fade resistant, yet incredibly soft to the touch.

With a large selection of solids, patterns, textures and jacquards, the possibilities are endless. Coordinate upholstery fabric with awnings, umbrellas, drapery, and more.

Sunbrella Canvas upholstery fabrics are solid fabrics, perfect for coordinating with Sunbrella patterned fabrics. Available in classic neutrals and a myriad of colors, Canvas is appropriate for upholstery for indoor and outdoor applications.

FABRIC	Sunbrella Acrylic
FINISH	Soil, Stain and Water Repellent Finish
FR STANDARDS MET	California Technical Bulletin 117-2013 Class 1
WARRANTY	5-Year

ITEM #	STYLE #	COLOR	PUT UP	WEIGHT	WIDTH
735410	5410-0000	Canvas Air Blue	40-60 yd.	8 oz.	54 in.
735422	5422-0000	Canvas Antique Beige	40-60 yd.	8 oz.	54 in.
735416	5416-0000	Canvas Aruba	40-60 yd.	8 oz.	54 in.
735232	5432-0000	Canvas Bay Brown	40-60 yd.	8 oz.	54 in.
735472	5472-0000	Canvas Birds Eye	40-60 yd.	8 oz.	54 in.
735408	5408-0000	Canvas Black	40-60 yd.	8 oz.	54 in.
743670	57000-0000	Canvas Blush	40-60 yd.	8 oz.	54 in.
735484	5484-0000	Canvas Brass	40-60 yd.	8 oz.	54 in.
735409	5409-0000	Canvas Brick	40-60 yd.	8 oz.	54 in.
735436	5436-0000	Canvas Burgundy	40-60 yd.	8 oz.	54 in.
735438	5438-0000	Canvas Buttercup	40-60 yd.	8 oz.	54 in.
735468	5468-0000	Canvas Camel	40-60 yd.	8 oz.	54 in.
735453	5453-0000	Canvas Canvas	40-60 yd.	8 oz.	54 in.
735226	5426-0000	Canvas Capri	40-60 yd.	8 oz.	54 in.
735948	54048-0000	Canvas Charcoal	40-60 yd.	8 oz.	54 in.
743671	57001-0000	Canvas Chestnut	40-60 yd.	8 oz.	54 in.
735489	5489-0000	Canvas Coal	40-60 yd.	8 oz.	54 in.
735325	5425-0000	Canvas Cocoa	40-60 yd.	8 oz.	54 in.
735248	5448-0000	Canvas Cork	40-60 yd.	8 oz.	54 in.
735491	5491-0000	Canvas Dusk	40-60 yd.	8 oz.	54 in.
735487	5487-0000	Canvas Fern	40-60 yd.	8 oz.	54 in.
735492	5492-0000	Canvas Flax	40-60 yd.	8 oz.	54 in.
735446	5446-0000	Canvas Forest Green	40-60 yd.	8 oz.	54 in.
735911	54011-0000	Canvas Ginkgo	40-60 yd.	8 oz.	54 in.
735228	5428-0000	Canvas Glacier	40-60 yd.	8 oz.	54 in.
735402	5402-0000	Canvas Granite	40-60 yd.	8 oz.	54 in.
735476	5476-0000	Canvas Heather Beige	40-60 yd.	8 oz.	54 in.
735407	5407-0000	Canvas Henna	40-60 yd.	8 oz.	54 in.
735562	5462-0000	Canvas Hot Pink	40-60 yd.	8 oz.	54 in.
743672	57002-0000	Canvas Iris	40-60 yd.	8 oz.	54 in.
735403	5403-0000	Canvas Jockey Red	40-60 yd.	8 oz.	54 in.
735477	5477-0000	Canvas Logo Red	40-60 yd.	8 oz.	54 in.
735229	5429-0000	Canvas Macaw	40-60 yd.	8 oz.	54 in.

ITEM #	STYLE #	COLOR	PUT UP	WEIGHT	WIDTH
735412	5412-0000	Canvas Maize	40-60 yd.	8 oz.	54 in.
735415	5415-0000	Canvas Melon	40-60 yd.	8 oz.	54 in.
735320	5420-0000	Canvas Mineral Blue	40-60 yd.	8 oz.	54 in.
735404	5404-0000	Canvas Natural	40-60 yd.	8 oz.	54 in.
735439	5439-0000	Canvas Navy	40-60 yd.	8 oz.	54 in.
735401	5401-0000	Canvas Pacific Blue	40-60 yd.	8 oz.	54 in.
735321	5421-0000	Canvas Palm	40-60 yd.	8 oz.	54 in.
735405	5405-0000	Canvas Parrot	40-60 yd.	8 oz.	54 in.
735471	5471-0000	Canvas Raven Black	40-60 yd.	8 oz.	54 in.
743715	5493-0000	Canvas Regatta	40-60 yd.	8 oz.	54 in.
735910	54010-0000	Canvas Rust	40-60 yd.	8 oz.	54 in.
735452	5452-0000	Canvas Sapphire Blue	40-60 yd.	8 oz.	54 in.
735424	5424-0000	Canvas Sky Blue	40-60 yd.	8 oz.	54 in.
735413	5413-0000	Canvas Spa	40-60 yd.	8 oz.	54 in.
735457	5457-0000	Canvas Sunflower	40-60 yd.	8 oz.	54 in.
735406	5406-0000	Canvas Tangerine	40-60 yd.	8 oz.	54 in.
735461	5461-0000	Canvas Taupe	40-60 yd.	8 oz.	54 in.
735488	5488-0000	Canvas Teak	40-60 yd.	8 oz.	54 in.
735456	5456-0000	Canvas Teal	40-60 yd.	8 oz.	54 in.
735240	5440-0000	Canvas Terracotta	40-60 yd.	8 oz.	54 in.
735499	5499-0000	Canvas True Blue	40-60 yd.	8 oz.	54 in.
735417	5417-0000	Canvas Tuscan	40-60 yd.	8 oz.	54 in.
735498	5498-0000	Canvas Vellum	40-60 yd.	8 oz.	54 in.
735470	5470-0000	Canvas Walnut	40-60 yd.	8 oz.	54 in.
735514	5414-0000	Canvas Wheat	40-60 yd.	8 oz.	54 in.
743673	57003-0000	Canvas White	40-60 yd.	8 oz.	54 in.

Sunbrella® is a registered trademark of Glen Raven, Inc.

Sunbrella® 2016-2017 Upholstery Collection – Dupione

Sunbrella upholstery fabrics make any space look stunning, with the strength to stand up to the elements and everyday use. Perfect for both indoor and outdoor applications, Sunbrella upholstery is water repellent, bleach cleanable and fade resistant, yet incredibly soft to the touch.

With a large selection of solids, patterns, textures and jacquards, the possibilities are endless. Coordinate upholstery fabric with awnings, umbrellas, drapery, and more.

Part of the upholstery collection, Dupione fabrics have a unique texture with a “Dupione” silk look.

FABRIC	Sunbrella Acrylic
FINISH	Soil, Stain and Water Repellent Finish
FR STANDARDS MET	California Technical Bulletin 117-2013 Class 1
WARRANTY	5-Year

ITEM #	STYLE #	COLOR	PUT UP	WEIGHT	WIDTH
738668	8068-0000	Dupione Aloe	40-60 yd.	10.1 oz.	54 in.
738613	8013-0000	Dupione Bamboo	40-60 yd.	10.1 oz.	54 in.
738659	8059-0000	Dupione Caramel	40-60 yd.	10.1 oz.	54 in.
738667	8067-0000	Dupione Celeste	40-60 yd.	10.1 oz.	54 in.
738612	8012-0000	Dupione Cornsilk	40-60 yd.	10.1 oz.	54 in.
738651	8051-0000	Dupione Crimson	40-60 yd.	10.1 oz.	54 in.
738619	8019-0000	Dupione Deep Sea	40-60 yd.	10.1 oz.	54 in.
738655	8069-0000	Dupione Dove	40-60 yd.	10.1 oz.	54 in.
738616	8016-0000	Dupione Galaxy	40-60 yd.	10.1 oz.	54 in.
738656	8056-0000	Dupione Henna	40-60 yd.	10.1 oz.	54 in.
738666	8066-0000	Dupione Latte	40-60 yd.	10.1 oz.	54 in.
738615	8015-0000	Dupione Laurel	40-60 yd.	10.1 oz.	54 in.
738664	8064-0000	Dupione Nectarine	40-60 yd.	10.1 oz.	54 in.
738657	8057-0000	Dupione Oak	40-60 yd.	10.1 oz.	54 in.
738652	8052-0000	Dupione Palm	40-60 yd.	10.1 oz.	54 in.
738653	8053-0000	Dupione Papaya	40-60 yd.	10.1 oz.	54 in.
738650	8050-0000	Dupione Paradise	40-60 yd.	10.1 oz.	54 in.
738610	8010-0000	Dupione Pearl	40-60 yd.	10.1 oz.	54 in.
738624	8024-0000	Dupione Peridot	40-60 yd.	10.1 oz.	54 in.
738611	8011-0000	Dupione Sand	40-60 yd.	10.1 oz.	54 in.
738660	8060-0000	Dupione Stone	40-60 yd.	10.1 oz.	54 in.
738617	8017-0000	Dupione Walnut	40-60 yd.	10.1 oz.	54 in.

Sunbrella® is a registered trademark of Glen Raven, Inc.

Sunbrella® 2016-2017 Upholstery Collection – Linen

Sunbrella upholstery fabrics make any space look stunning, with the strength to stand up to the elements and everyday use. Perfect for both indoor and outdoor applications, Sunbrella upholstery is water repellent, bleach cleanable and fade resistant, yet incredibly soft to the touch.

With a large selection of solids, patterns, textures and jacquards, the possibilities are endless. Coordinate upholstery fabric with awnings, umbrellas, drapery, and more.

Also part of the upholstery collection Sunbrella linen is woven to look like traditional linen, but offers the same durability as other Sunbrella fabrics.

FABRIC	Sunbrella Acrylic
FINISH	Soil, Stain and Water Repellent Finish
FR STANDARDS MET	California Technical Bulletin 117-2013 Class 1
WARRANTY	5-Year

ITEM #	STYLE #	COLOR	PUT UP	WEIGHT	WIDTH
738322	8322-0000	Linen Antique Beige	40-60 yd.	8.9 oz.	54 in.
738353	8353-0000	Linen Canvas	40-60 yd.	8.9 oz.	54 in.
738300	8300-0000	Linen Champagne	40-60 yd.	8.9 oz.	54 in.
738309	8306-0000	Linen Chili	40-60 yd.	8.9 oz.	54 in.
738304	8304-0000	Linen Natural	40-60 yd.	8.9 oz.	54 in.
738317	8317-0000	Linen Pampas	40-60 yd.	8.9 oz.	54 in.
738318	8318-0000	Linen Sesame	40-60 yd.	8.9 oz.	54 in.
738351	8351-0000	Linen Silver	40-60 yd.	8.9 oz.	54 in.
738319	8319-0000	Linen Stone	40-60 yd.	8.9 oz.	54 in.
738314	8314-0000	Linen Straw	40-60 yd.	8.9 oz.	54 in.
738374	8374-0000	Linen Taupe	40-60 yd.	8.9 oz.	54 in.

Sunbrella® is a registered trademark of Glen Raven, Inc.

Sunbrella® 2016-2017 Upholstery Collection – Sailcloth

Sunbrella upholstery fabrics make any space look stunning, with the strength to stand up to the elements and everyday use. Perfect for both indoor and outdoor applications, Sunbrella upholstery is water repellent, bleach cleanable and fade resistant, yet incredibly soft to the touch.

With a large selection of solids, patterns, textures and jacquards, the possibilities are endless. Coordinate upholstery fabric with awnings, umbrellas, drapery, and more.

Sailcloth is ideal for applications where a little extra strength is desired, but also retains the soft hand of Sunbrella upholstery fabrics. Sailcloth is available in a # of neutral colors.

FABRIC	Sunbrella Acrylic
FINISH	Soil, Stain and Water Repellent Finish
FR STANDARDS MET	California Technical Bulletin 117-2013 Class 1
WARRANTY	5-Year

ITEM #	STYLE #	COLOR	PUT UP	WEIGHT	WIDTH
743216	32000-0016	Sailcloth Sahara	40-60 yd.	13.9 oz.	54 in.
743226	32000-0026	Sailcloth Sailor	40-60 yd.	13.9 oz.	54 in.
743218	32000-0018	Sailcloth Salt	40-60 yd.	13.9 oz.	54 in.
743202	32000-0002	Sailcloth Sand	40-60 yd.	13.9 oz.	54 in.
743223	32000-0023	Sailcloth Seagull	40-60 yd.	13.9 oz.	54 in.
743699	32000-0036	Sailcloth Shade	40-60 yd.	13.9 oz.	54 in.
743225	32000-0025	Sailcloth Shadow	40-60 yd.	13.9 oz.	54 in.
743200	32000-0000	Sailcloth Shell	40-60 yd.	13.9 oz.	54 in.
743203	32000-0003	Sailcloth Shore	40-60 yd.	13.9 oz.	54 in.
743217	32000-0017	Sailcloth Sienna	40-60 yd.	13.9 oz.	54 in.
743205	32000-0024	Sailcloth Sisal	40-60 yd.	13.9 oz.	54 in.
743698	32000-0027	Sailcloth Space	40-60 yd.	13.9 oz.	54 in.
743219	32000-0019	Sailcloth Spice	40-60 yd.	13.9 oz.	54 in.
743207	32000-0007	Sailcloth Suntan	40-60 yd.	13.9 oz.	54 in.

Sunbrella® is a registered trademark of Glen Raven, Inc.

Sunbrella® 2016-2017 Upholstery Collection – Spectrum

Sunbrella upholstery fabrics make any space look stunning, with the strength to stand up to the elements and everyday use. Perfect for both indoor and outdoor applications, Sunbrella upholstery is water repellent, bleach cleanable and fade resistant, yet incredibly soft to the touch.

With a large selection of solids, patterns, textures and jacquards, the possibilities are endless. Coordinate upholstery fabric with awnings, umbrellas, drapery, and more.

Spectrum is a variation of Canvas with a slight ribbed pattern, and is appropriate for both indoor and outdoor upholstery applications.

FABRIC	Sunbrella Acrylic
FINISH	Soil, Stain and Water Repellent Finish
FR STANDARDS MET	California Technical Bulletin 117-2013 Class 1
WARRANTY	5-Year

ITEM #	STYLE #	COLOR	PUT UP	WEIGHT	WIDTH
743232	48082-0000	Spectrum Almond	40-60 yd.	7.1 oz.	54 in.
743235	48085-0000	Spectrum Carbon	40-60 yd.	7.1 oz.	54 in.
743233	48083-0000	Spectrum Caribou	40-60 yd.	7.1 oz.	54 in.
743326	48026-0000	Spectrum Cayenne	40-60 yd.	7.1 oz.	54 in.
743322	48022-0000	Spectrum Cilantro	40-60 yd.	7.1 oz.	54 in.
743329	48029-0000	Spectrum Coffee	40-60 yd.	7.1 oz.	54 in.
743245	48035-0000	Spectrum Crimson	40-60 yd.	7.1 oz.	54 in.
743324	48024-0000	Spectrum Daffodil	40-60 yd.	7.1 oz.	54 in.
743236	48086-0000	Spectrum Denim	40-60 yd.	7.1 oz.	54 in.
743332	48032-0000	Spectrum Dove	40-60 yd.	7.1 oz.	54 in.
743318	48018-0000	Spectrum Eggshell	40-60 yd.	7.1 oz.	54 in.
743330	48030-0000	Spectrum Graphite	40-60 yd.	7.1 oz.	54 in.
743327	48027-0000	Spectrum Grenadine	40-60 yd.	7.1 oz.	54 in.
743230	48080-0000	Spectrum Indigo	40-60 yd.	7.1 oz.	54 in.
743323	48023-0000	Spectrum Kiwi	40-60 yd.	7.1 oz.	54 in.
743320	48020-0000	Spectrum Mist	40-60 yd.	7.1 oz.	54 in.
743331	48031-0000	Spectrum Mushroom	40-60 yd.	7.1 oz.	54 in.
743231	48081-0000	Spectrum Peacock	40-60 yd.	7.1 oz.	54 in.
743319	48019-0000	Spectrum Sand	40-60 yd.	7.1 oz.	54 in.
743234	48084-0000	Spectrum Sesame	40-60 yd.	7.1 oz.	54 in.
743328	48028-0000	Spectrum Sierra	40-60 yd.	7.1 oz.	54 in.

Sunbrella® is a registered trademark of Glen Raven, Inc.

Sunbrella® 2016-2017 Upholstery Collection – Rib

Sunbrella upholstery fabrics make any space look stunning, with the strength to stand up to the elements and everyday use. Perfect for both indoor and outdoor applications, Sunbrella upholstery is water repellent, bleach cleanable and fade resistant, yet incredibly soft to the touch.

With a large selection of solids, patterns, textures and jacquards, the possibilities are endless. Coordinate upholstery fabric with awnings, umbrellas, drapery, and more.

Sunbrella Rib fabrics are specifically designed to withstand the rigors of sling furniture use. The added polyester yarns give the fabric its needed strength.

FABRIC	Sunbrella Acrylic, Polyester
FINISH	Soil, Stain and Water Repellent Finish
FR STANDARDS MET	California Technical Bulletin 117-2013 Class 1
WARRANTY	5-Year

ITEM #	STYLE #	COLOR	PUT UP	WEIGHT	WIDTH
743684	7774-0000	Carousel Confetti	40-60 yd.	13.5 oz.	54 in.
743685	7775-0000	Carousel Limelite	40-60 yd.	13.5 oz.	54 in.
737704	7704-0000	Rib Natural	45 yd.	13.5 oz.	54 in.
732561	7761-0000	Rib Taupe/Antique Beige	45 yd.	13.5 oz.	54 in.

Sunbrella® is a registered trademark of Glen Raven, Inc.



Sunbrella® Rain

Sunbrella Rain is a 100% waterproof version of Sunbrella upholstery fabrics. Not only does it hold the same fade resistance and mold and mildew resistance you expect from Sunbrella, with Sunbrella Rain, cushions are able to quickly dry.

Do not machine wash Sunbrella Rain fabrics. Please refer to www.trivantage.com for fabrication techniques for Sunbrella Rain.

FABRIC	Sunbrella Acrylic
FR STANDARDS MET	California Technical Bulletin 117-2013 Class 1
WARRANTY	5-Year

ITEM #	STYLE #	COLOR	COLOR #	PUT UP	WEIGHT	WIDTH
738495	5612-0000 77	Brannon Redwood		40-60 yd.	8.3 oz.	54 in.
738422	5422-0000 77	Canvas Antique Beige		40-60 yd.	8.3 oz.	54 in.
738408	5408-0000 77	Canvas Black		40-60 yd.	8.3 oz.	54 in.
738510	5409-0000 77	Canvas Brick		40-60 yd.	8.3 oz.	54 in.
738453	5453-0000 77	Canvas Canvas		40-60 yd.	8.3 oz.	54 in.
738489	5489-0000 77	Canvas Coal		40-60 yd.	8.3 oz.	54 in.
738425	5425-0000 77	Canvas Cocoa		40-60 yd.	8.3 oz.	54 in.
738511	5487-0000 77	Canvas Fern		40-60 yd.	8.3 oz.	54 in.
738411	54011-0000 77	Canvas Ginkgo		40-60 yd.	8.3 oz.	54 in.
738406	5402-0000 77	Canvas Granite		40-60 yd.	8.3 oz.	54 in.
738476	5476-0000 77	Canvas Heather Beige		40-60 yd.	8.3 oz.	54 in.
738407	5407-0000 77	Canvas Henna		40-60 yd.	8.3 oz.	54 in.
738403	5403-0000 77	Canvas Jockey Red		40-60 yd.	8.3 oz.	54 in.
738439	5439-0000 77	Canvas Navy		40-60 yd.	8.3 oz.	54 in.
738413	5413-0000 77	Canvas Spa		40-60 yd.	8.3 oz.	54 in.
738461	5461-0000 77	Canvas Taupe		40-60 yd.	8.3 oz.	54 in.
738488	5488-0000 77	Canvas Teak		40-60 yd.	8.3 oz.	54 in.
738493	8013-0000 77	Dupione Bamboo		40-60 yd.	10.1 oz.	54 in.

Sunbrella® Heritage

Building on our reputation for sustainable, high performance fabric solutions, we introduce Heritage – a Sunbrella upholstery fabric featuring 50% recycled content. With a homespun look and extensive color palette, the fabric is an expansion of our existing Sunbrella Renaissance Collection of recycled products. Heritage is a blend of post-industrial recycled Sunbrella and Sunbrella virgin fiber that helps ensure that the product meets stringent Sunbrella performance standards. Because Heritage is made with 50% recycled content, there can be variations in color from lot to lot and even within a master roll. Slub yarns and fiber variations are part of the design of this product. There is a greater degree of variation in this product line than in others with blended fibers and slub yarns.

FABRIC	50% Sunbrella Acrylic, 50% Recycled Sunbrella Acrylic
FINISH	Soil, Stain and Water Repellent Finish
FR STANDARDS MET	California Technical Bulletin 117-2013 Class 1
WARRANTY	5-Year

ITEM #	STYLE #	COLOR	PUT UP	WEIGHT	WIDTH
735280	18000-0000	Heritage Alpaca	40-60 yd.	11 oz.	54 in.
735281	18001-0000	Heritage Ashe	40-60 yd.	11 oz.	54 in.
735288	18009-0000	Heritage Char	40-60 yd.	11 oz.	54 in.
735289	18010-0000	Heritage Denim	40-60 yd.	11 oz.	54 in.
735282	18003-0000	Heritage Garnet	40-60 yd.	11 oz.	54 in.
735283	18004-0000	Heritage Granite	40-60 yd.	11 oz.	54 in.
735290	18011-0000	Heritage Leaf	40-60 yd.	11 oz.	54 in.
735284	18005-0000	Heritage Mink	40-60 yd.	11 oz.	54 in.
735291	18012-0000	Heritage Moss	40-60 yd.	11 oz.	54 in.
735285	18006-0000	Heritage Papyrus	40-60 yd.	11 oz.	54 in.
735286	18007-0000	Heritage Pumpkin	40-60 yd.	11 oz.	54 in.
735287	18008-0000	Heritage Wheat	40-60 yd.	11 oz.	54 in.

Sunbrella® is a registered trademark of Glen Raven, Inc.

ITEM #	STYLE #	COLOR	COLOR #	PUT UP	WEIGHT	WIDTH
738513	8067-0000 77	Dupione Celeste		40-60 yd.	10.1 oz.	54 in.
738512	8016-0000 77	Dupione Galaxy		40-60 yd.	10.1 oz.	54 in.
738502	8066-0000 77	Dupione Latte		40-60 yd.	10.1 oz.	54 in.
738491	8011-0000 77	Dupione Sand		40-60 yd.	10.1 oz.	54 in.
738500	56049-0000 77	Foster Surfside		40-60 yd.	8.3 oz.	54 in.
738503	8300-0000 77	Linen Champagne		40-60 yd.	8.9 oz.	54 in.
738499	8318-0000 77	Linen Sesame		40-60 yd.	8.9 oz.	54 in.
738494	8314-0000 77	Linen Straw		40-60 yd.	8.9 oz.	54 in.
738497	32000-0016 77	Sailcloth Sahara		40-60 yd.	13.9 oz.	54 in.
738498	32000-0018 77	Sailcloth Salt		40-60 yd.	13.9 oz.	54 in.
738496	48026-0000 77	Spectrum Cayenne		40-60 yd.	7.1 oz.	54 in.
738492	48022-0000 77	Spectrum Cilantro		40-60 yd.	7.1 oz.	54 in.
738508	48032-0000 77	Spectrum Dove		40-60 yd.	7.1 oz.	54 in.
738506	48031-0000 77	Spectrum Mushroom		40-60 yd.	7.1 oz.	54 in.

Sunbrella® is a registered trademark of Glen Raven, Inc.

Sunbrella® Shadow

Discover fabrics that filter light while adding style and privacy to indoor and outdoor areas. Designed for use in awnings, market umbrellas, privacy screens and architectural embellishments on gazebos and other outdoor structures, Sunbrella Shade Shadow filters and diffuses light and adds privacy or decorative embellishments without completely blocking the sun.

Sunbrella Shadow features a mock-leno weave in which space is locked into the fabric, limiting the amount of sun blocked. It also allows water to pass through for fast drying and prevents weight gain from water retention that can damage architectural structures.

Offered in a variety of colors, Sunbrella Shade Shadow coordinates with many popular Sunbrella solid awning and furniture fabric colors.

FABRIC	Sunbrella Acrylic
FINISH	Soil, Stain and Water Repellent Finish
FR STANDARDS MET	California Technical Bulletin 117-2013 Class 1
WARRANTY	5-Year

ITEM #	STYLE #	COLOR	PUT UP	WEIGHT	WIDTH
740433	51000-0013	Shadow Charcoal	60 yd.	6 oz.	54 in.
740421	51000-0001	Shadow Sand	60 yd.	6 oz.	54 in.
740420	51000-0000	Shadow Snow	60 yd.	6 oz.	54 in.

Sunbrella® is a registered trademark of Glen Raven, Inc.



Sunbrella® Sheer

Sunbrella Sheer performance fabric is fade-resistant and ideal for draperies and architectural structures that call for luxurious, romantic embellishments.

Sunbrella Sheer fabric is woven from Sunbrella yarns, which makes it long lasting even under long-term sun exposure. The fabric also offers soil release for easy cleaning. In addition, water can flow through the fabric, allowing for fast drying and avoiding the risk of damage to architectural structures from weight gain due to water retention.

This plain flat weave fabric is a light, wispy sheer that takes on the coloration of background elements. And since Sunbrella Sheer is made with Sunbrella yarns, it coordinates with the entire Sunbrella decorative fabric line.

FABRIC	Sunbrella Acrylic
FR STANDARDS MET	California Technical Bulletin 117-2013 Class 1
WARRANTY	5-Year

ITEM #	STYLE #	COLOR	PUT UP	WEIGHT	WIDTH
740415	52001-0005	Mist Dove	60 yd.	4 oz.	54 in.
740413	52001-0003	Mist Honey	60 yd.	4 oz.	54 in.
740411	52001-0001	Mist Parchment	60 yd.	4 oz.	54 in.
740412	52001-0002	Mist Sand	60 yd.	4 oz.	54 in.
740410	52001-0000	Mist Snow	60 yd.	4 oz.	54 in.
740414	52001-0004	Mist Wren	60 yd.	4 oz.	54 in.

Sunbrella® is a registered trademark of Glen Raven, Inc.



Sunbrella® Sling

Sunbrella Sling is a patented performance fabric that combines the exceptional strength of vinyl yarns with the softness of Sunbrella. These extremely durable outdoor fabrics are primarily used in sling chair applications. Sunbrella Sling is fade and stain resistant, and provides a sleek designer look and effortless maintenance.

FABRIC	PVC Coated Polyester/Sunbrella
FR STANDARDS MET	California Technical Bulletin 117-2013 Class 1
WARRANTY	5-Year

ITEM #	STYLE #	COLOR	PUT UP	WEIGHT	WIDTH
793912	5928-0042	Augustine Alloy	45 yd.	15.7 oz.	54 in.
793911	5928-0041	Augustine Amethyst	45 yd.	15.7 oz.	54 in.
794124	5928-0054	Augustine Ashe	45 yd.	15.7 oz.	54 in.
793913	5928-0043	Augustine Denim	45 yd.	15.7 oz.	54 in.
793947	5928-0017	Augustine Espresso	45 yd.	15.7 oz.	54 in.
794123	5928-0053	Augustine Fawn	45 yd.	15.7 oz.	54 in.
793800	5928-0033	Augustine Fennel	45 yd.	15.7 oz.	54 in.
793909	5928-0039	Augustine Frost	45 yd.	15.7 oz.	54 in.
794120	5928-0049	Augustine Golden	45 yd.	15.7 oz.	54 in.
793957	5928-0007	Augustine Gravel	45 yd.	14.7 oz.	54 in.
794122	5928-0051	Augustine Marine	45 yd.	15.7 oz.	54 in.
793801	5928-0034	Augustine Moss	45 yd.	15.7 oz.	54 in.
793948	5928-0018	Augustine Nutmeg	45 yd.	15.7 oz.	54 in.
793910	5928-0040	Augustine Pear	45 yd.	15.7 oz.	54 in.
794121	5928-0050	Augustine Pearl	45 yd.	15.7 oz.	54 in.
793954	5928-0031	Augustine Pebble	45 yd.	15.7 oz.	54 in.
793803	5928-0032	Augustine Pecan	45 yd.	15.7 oz.	54 in.
794119	5928-0048	Augustine Pewter	45 yd.	15.7 oz.	54 in.
793940	50135-0000	Barlow Mocha	45 yd.	14.9 oz.	54 in.
793869	5300-0000	Baron Oak	35 yd.	21.1 oz.	54 in.
793963	50016-0006	Bossa Nova Graphite	45 yd.	14.9 oz.	54 in.

ITEM #	STYLE #	COLOR	PUT UP	WEIGHT	WIDTH
793850	5301-0006	Calvin Spice	45 yd.	21.8 oz.	54 in.
793825	5318-0002	Casteel Dune	45 yd.	17.8 oz.	54 in.
793827	5318-0001	Casteel Straw	45 yd.	17.8 oz.	54 in.
794132	5312-0001	Corcovado Lichen	45 yd.	17.8 oz.	54 in.
794134	5312-0003	Corcovado Oak	45 yd.	17.8 oz.	54 in.
793996	50078-0006	Destiny Sand	45 yd.	15.7 oz.	54 in.
793993	50078-0003	Destiny Walnut	45 yd.	15.7 oz.	54 in.
793839	5290-0003	Dublin Oak	45 yd.	17.8 oz.	54 in.
794127	50178-0000	Duette Sand	45 yd.	18.3 oz.	54 in.
794128	50179-0000	Duette Shadow	45 yd.	18.3 oz.	54 in.
793855	50184-0000	Elevation Oak	45 yd.	15.7 oz.	54 in.
793856	50183-0000	Elevation Stone	45 yd.	15.7 oz.	54 in.
793857	5319-0000	Force Oak	45 yd.	16.5 oz.	54 in.
793858	5319-0002	Force Slate	45 yd.	16.5 oz.	54 in.
793859	5319-0001	Force Sparrow	45 yd.	16.5 oz.	54 in.
793815	50162-0003	Frontier Barley	45 yd.	15.7 oz.	54 in.
793816	50162-0006	Frontier Everglade	45 yd.	15.7 oz.	54 in.
793817	50162-0008	Frontier Redwood	45 yd.	15.7 oz.	54 in.
793967	50017-0007	Havana Java	45 yd.	14.9 oz.	54 in.
793834	5288-0000	Igneous Cappuccino	45 yd.	17.6 oz.	54 in.
793836	5288-0005	Igneous Granite	45 yd.	17.6 oz.	54 in.
793835	5288-0001	Igneous Sesame	45 yd.	17.6 oz.	54 in.
793860	5317-0001	Keetley Birch	45 yd.	17.2 oz.	54 in.
793866	5317-0002	Keetley Jay	45 yd.	17.2 oz.	54 in.
793867	5317-0000	Keetley Prairie	45 yd.	17.2 oz.	54 in.
793961	5929-0001	Lamont Curry	45 yd.	14 oz.	54 in.
793872	50045-0018	Logan Graphite	45 yd.	14.9 oz.	54 in.
793818	50045-0001	Logan Ocean	45 yd.	14.9 oz.	54 in.
794135	5314-0001	Madison Barley	45 yd.	16.3 oz.	54 in.
794137	5314-0003	Madison Cajun	45 yd.	16.3 oz.	54 in.
793982	50160-0000	Mahjong II Teak	45 yd.	15.7 oz.	54 in.
793864	5226-0005	Mattox 6005PB	45 yd.	16.5 oz.	54 in.
793968	5973-0001	Myrtle 7001BN	45 yd.	14.3 oz.	54 in.
794118	5323-0002	Ramona Dove	45 yd.	19.4 oz.	54 in.
794116	5323-0000	Ramona Parchment	45 yd.	19.4 oz.	54 in.
794117	5323-0001	Ramona Parchment	45 yd.	19.4 oz.	54 in.
794112	50143-0020	Sailing Sahara	45 yd.	18.3 oz.	54 in.
793844	50143-0000	Sailing Salt	45 yd.	18.3 oz.	54 in.
793848	50143-0010	Sailing Seagull	45 yd.	18.3 oz.	54 in.
794110	50143-0018	Sailing Shade	45 yd.	18.3 oz.	54 in.
793847	50143-0004	Sailing Sienna	45 yd.	18.3 oz.	54 in.
794111	50143-0019	Sailing Space	45 yd.	18.3 oz.	54 in.
793845	50143-0003	Sailing Suntan	45 yd.	18.3 oz.	54 in.
793813	50171-0000	Shangrila Dove	45 yd.	15.7 oz.	54 in.
793812	50170-0000	Shangrila Seagrass	45 yd.	15.7 oz.	54 in.
793811	50169-0000	Stafford Cedar	45 yd.	16.1 oz.	54 in.
794177	6829-0000	Weyburn 7001PB	45 yd.	14.3 oz.	54 in.
793906	5910-0006	Weyburn Redwood	45 yd.	14.7 oz.	54 in.

Sunbrella® is a registered trademark of Glen Raven, Inc.

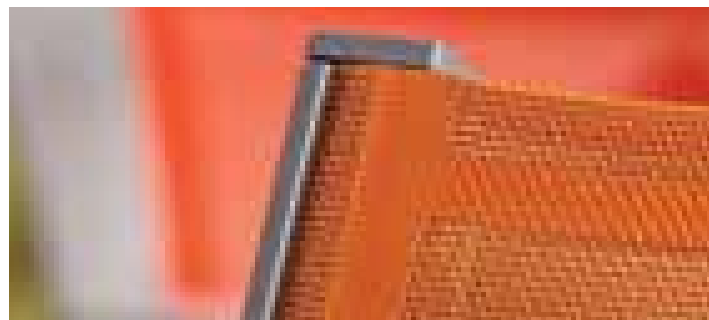

Phifertex®

Phifertex is ideal for lawn and patio furniture, umbrellas, office furniture, orthopedic equipment, upholstery, safety vests, and unique heat-filtering awnings.

Phifertex is infused with Microban® antimicrobial product protection, helping to provide an additional level of cleanliness protection that won't wash or wear away for the lifetime of the fabric. Microban protection inhibits the growth of stain and odor-causing bacteria, mold and mildew and works continuously, keeping fabrics cleaner for longer. This product is GREENGUARD® certified for low chemical emissions. UL.Com/GG, UL2818.

FABRIC	Vinyl Encapsulated Polyester Yarns
FR STANDARDS MET	California Technical Bulletin 117, Section E
WARRANTY	3-Year

ITEM #	STYLE #	COLOR	FABRIC COUNT	PUT UP	WEIGHT	WIDTH
997145	186	Almond	17 x 11	60 yd.	11.7 oz.	54 in.
997150	X11	Ash Gray	17 x 11	60 yd.	11.7 oz.	54 in.
997152	X04	Black	17 x 11	60 yd.	11.7 oz.	54 in.
997148	800	Brown	17 x 11	60 yd.	11.7 oz.	54 in.
997149	812	Camel	17 x 11	60 yd.	11.7 oz.	54 in.
997235	X00	Grey Sand	17 x 11	60 yd.	11.7 oz.	54 in.
997147	G01	Navy	17 x 11	60 yd.	11.7 oz.	54 in.
997146	412	Orange	17 x 11	60 yd.	11.7 oz.	54 in.
997173	M96	Red	17 x 11	60 yd.	11.7 oz.	54 in.
997141	G00	Royal Blue	17 x 11	60 yd.	11.7 oz.	54 in.
997136	A40	Spice	17 x 11	60 yd.	11.7 oz.	54 in.
997171	C09	Spruce	17 x 11	60 yd.	11.7 oz.	54 in.
997142	000	White	17 x 11	60 yd.	11.7 oz.	54 in.
997143	406	Yellow	17 x 11	60 yd.	11.7 oz.	54 in.

997173 - Trivantage® makes no claim as to the colorfastness of M96 Red. Customer should determine suitability of fabric to needs.

Phifertex® is a registered trademark of Phifer Inc. Microban® is a registered trademark of Microban Products Company. GREENGUARD® is a registered trademark of GREENGUARD Environmental Institute.

Phifertex® Plus

Designed especially for sling and umbrella applications.

Phifertex is infused with Microban® antimicrobial product protection, helping to provide an additional level of cleanliness protection that won't wash or wear away for the lifetime of the fabric. Microban protection inhibits the growth of stain and odor-causing bacteria, mold and mildew and works continuously, keeping fabrics cleaner for longer. This product is GREENGUARD® certified.

FABRIC	Vinyl Encapsulated Polyester Yarns
FR STANDARDS MET	California Technical Bulletin 117, Section E
WARRANTY	3-Year

ITEM #	STYLE #	COLOR	FABRIC COUNT	PUT UP	WEIGHT	WIDTH
997298	X04	Black	42 x 12	60 yd.	16.5 oz. (+/- 0.5)	54 in.
997299	BH4	Burlap	42 x 12	60 yd.	16.5 oz. (+/- 0.5)	54 in.
997557	DJ7	Dupione Kiwi	42 x 12	60 yd.	16.5 oz. (+/- 0.5)	54 in.
997555	L37	Dupione Poolside	42 x 12	60 yd.	16.5 oz. (+/- 0.5)	54 in.
997316	L96	Dupione Sapphire	42 x 14	60 yd.	16.5 oz. (+/- 0.5)	54 in.
997315	KT1	Dupione Spice	42 x 14	60 yd.	16.5 oz. (+/- 0.5)	54 in.
997289	DB6	Garden Green	42 x 12	60 yd.	16.5 oz. (+/- 0.5)	54 in.
997108	X00	Grey Sand	42 x 12	60 yd.	16.5 oz. (+/- 0.5)	54 in.
997122	CL1	Holly Green	42 x 12	60 yd.	16.5 oz. (+/- 0.5)	54 in.
997464	XUP	Metallica Platinum	42 x 14	60 yd.	16.5 oz. (+/- 0.5)	54 in.
997302	KK3	Metallica Salsa	42 x 12	60 yd.	16.5 oz. (+/- 0.5)	54 in.
997314	XXG	Metallica Smoke	42 x 14	60 yd.	16.5 oz. (+/- 0.5)	54 in.
997300	OHK	Metallica White	42 x 14	60 yd.	16.5 oz. (+/- 0.5)	54 in.
997124	GP5	Navy Pier	42 x 12	60 yd.	16.5 oz. (+/- 0.5)	54 in.
997125	G00	Royal Blue	42 x 12	60 yd.	16.5 oz. (+/- 0.5)	54 in.
997295	KG4	Salsa	42 x 12	60 yd.	16.5 oz. (+/- 0.5)	54 in.
997288	KF4	Snappy	42 x 12	60 yd.	16.5 oz. (+/- 0.5)	54 in.
997498	LEA	Spring Tweed Aqua Shimmer	42 x 14	60 yd.	16.5 oz. (+/- 0.5)	54 in.
997497	DAV	Spring Tweed Citronelle	42 x 14	60 yd.	16.5 oz. (+/- 0.5)	54 in.
997301	LBY	Straw Mat Blue	42 x 14	60 yd.	16.5 oz. (+/- 0.5)	54 in.
997129	OY3	Stucco	42 x 12	60 yd.	16.5 oz. (+/- 0.5)	54 in.
997472	LDC	Tweed Indigo	42 x 14	60 yd.	16.5 oz. (+/- 0.5)	54 in.
997471	DAH	Tweed Taffy	42 x 14	60 yd.	16.5 oz. (+/- 0.5)	54 in.
997121	000	White	42 x 12	60 yd.	16.5 oz. (+/- 0.5)	54 in.
997123	406	Yellow	42 x 12	60 yd.	16.5 oz. (+/- 0.5)	54 in.

Phifertex® is a registered trademark of Phifer Incorporated. Microban® is a registered trademark of Microban Products Company. GREENGUARD® is a registered trademark of GREENGUARD Environmental Institute.

Phifertex® Stripes

Phifertex is infused with Microban® antimicrobial product protection, helping to provide an additional level of cleanliness protection that won't wash or wear away for the lifetime of the fabric. Microban protection inhibits the growth of stain and odor-causing bacteria, mold and mildew and works continuously, keeping fabrics cleaner for longer. This product is GREENGUARD® certified for low chemical emissions. UL.Com/GG, UL2818.

FABRIC	Vinyl Encapsulated Polyester Yarns
FR STANDARDS MET	California Technical Bulletin 117, Section E
WARRANTY	3-Year

ITEM #	STYLE #	COLOR	FABRIC COUNT	PUT UP	WEIGHT	WIDTH
997429	GYO	Aquafino	42 x 14	60 yd.	16.5 oz. (+/- 0.5)	54 in.
997494	LEB	Bailey Stripe Aqua Shimmer	42 x 14	60 yd.	16.5 oz. (+/- 0.5)	54 in.
997493	DAW	Bailey Stripe Citronelle	42 x 14	60 yd.	16.5 oz. (+/- 0.5)	54 in.
997137	687	Charisma Citrus	42 x 14	60 yd.	16.5 oz. (+/- 0.5)	54 in.
997468	XUM	Coastline Peacock	42 x 14	60 yd.	16.5 oz. (+/- 0.5)	54 in.
997552	DJ5	Delray Stripe Conch	42 x 14	60 yd.	16.5 oz. (+/- 0.5)	54 in.
997551	DJ6	Delray Stripe Kiwi	42 x 14	60 yd.	16.5 oz. (+/- 0.5)	54 in.
997550	L38	Delray Stripe Poolside	42 x 14	60 yd.	16.5 oz. (+/- 0.5)	54 in.
997139	LAN	Leena Indigo	42 x 14	60 yd.	16.5 oz. (+/- 0.5)	54 in.
997619	NH4	Martindale Pewter	42 x 14	60 yd.	16.5 oz. (+/- 0.5)	54 in.
997614	EY1	Pulse Dahlia	42 x 14	60 yd.	16.5 oz. (+/- 0.5)	54 in.
997613	EY0	Pulse Kiwi	42 x 14	60 yd.	16.5 oz. (+/- 0.5)	54 in.
997473	DAI	Raleigh Stripe Willow	42 x 14	60 yd.	16.5 oz. (+/- 0.5)	54 in.
997433	KG3	Santiago Stripe	42 x 14	60 yd.	16.5 oz. (+/- 0.5)	54 in.
997475	NN5	Saylor Stripe Sepia	42 x 14	60 yd.	16.5 oz. (+/- 0.5)	54 in.
997466	XUQ	Skyline Stripe Verde	42 x 14	60 yd.	16.5 oz. (+/- 0.5)	54 in.
997138	DW3	Sumi Sea Mist	42 x 14	60 yd.	16.5 oz. (+/- 0.5)	54 in.
997616	YAC	Tempo Stone	42 x 14	60 yd.	16.5 oz. (+/- 0.5)	54 in.
997474	LDB	Trixie Stripe Myrtle	42 x 14	60 yd.	16.5 oz. (+/- 0.5)	54 in.
997618	NH3	Whatley Dune	42 x 14	60 yd.	16.5 oz. (+/- 0.5)	54 in.
997441	L09	Windsor Stripe Spa	42 x 14	60 yd.	16.5 oz. (+/- 0.5)	54 in.
997617	LBX	Winsted Stripe Beach	42 x 14	60 yd.	16.5 oz. (+/- 0.5)	54 in.

Phifertex® is a registered trademark of Phifer Incorporated. Microban® is a registered trademark of Microban Products Company. GREENGUARD® is a registered trademark of GREENGUARD Environmental Institute.



Phifertex® Cane Wicker Collection

Phifertex is ideal for lawn and patio furniture, umbrellas, office furniture, orthopedic equipment, upholstery, safety vests, and unique heat-filtering awnings.

Phifertex is infused with Microban® antimicrobial product protection, helping to provide an additional level of cleanliness protection that won't wash or wear away for the lifetime of the fabric. Microban protection inhibits the growth of stain and odor-causing bacteria, mold and mildew and works continuously, keeping fabrics cleaner for longer. This product is GREENGUARD® certified for low chemical emissions. UL.Com/GG, UL2818.

FABRIC	Vinyl Encapsulated Polyester Yarns
FR STANDARDS MET	California Technical Bulletin 117, Section E
WARRANTY	3-Year

ITEM #	STYLE #	COLOR	FABRIC COUNT	PUT UP	WEIGHT	WIDTH
997510	CX2	Aluminum	25 x 25	60 yd.	22 oz.	54 in.
997508	CX3	Balsa	25 x 25	60 yd.	22 oz.	54 in.
997583	EH3	Bellingrath	25 x 20	60 yd.	18.9 oz.	54 in.
997594	OFE	Cane Oyster	25 x 25	60 yd.	18 oz.	54 in.
997487	LED	Charm Blue Haven	22 x 18	60 yd.	17.2 oz.	54 in.
997726	NP2	Charm Driftwood	25 x 25	60 yd.	17.2 oz.	54 in.
997725	NN7	Charm Glacier	25 x 25	60 yd.	17.2 oz.	54 in.
997723	LDE	Charm Indigo	25 x 25	60 yd.	17.2 oz.	54 in.
997486	NS4	Charm Stucco	22 x 18	60 yd.	17.2 oz.	54 in.
997712	LBZ	Clarity Blue	25 x 25	60 yd.	21.1 oz.	54 in.
997720	NH5	Clarity Pearl	25 x 25	60 yd.	21.1 oz.	54 in.
997721	NH6	Clarity Sea Fog	25 x 25	60 yd.	21.1 oz.	54 in.
997543	EC1	Coral Topaz	25 x 25	60 yd.	21.1 oz.	54 in.
997580	EH4	Cordoba Copper	22 x 20	60 yd.	17.7 oz.	54 in.
997581	XSX	Cordoba Ninja	22 x 20	60 yd.	17.7 oz.	54 in.
997531	NC2	Cortez Clay	25 x 25	60 yd.	21.1 oz.	54 in.
997713	NG2	Cortez Earth	25 x 25	60 yd.	21.1 oz.	54 in.
997711	LBL	Cortez Navy	25 x 25	60 yd.	21.1 oz.	54 in.
997529	DW5	Cortez Thyme	25 x 25	60 yd.	21.1 oz.	54 in.
997501	AD7	Desert	25 x 25	60 yd.	22 oz.	54 in.
997540	BT3	Double Dipper	25 x 25	60 yd.	22 oz.	54 in.

ITEM #	STYLE #	COLOR	FABRIC COUNT	PUT UP	WEIGHT	WIDTH
997585	EH6	Echo Valley Sadat	25 x 25	60 yd.	21.1 oz.	54 in.
997707	XZY	Kamali Limestone	25 x 20	60 yd.	18.9 oz.	54 in.
997715	NG4	Lanigan	25 x 20	60 yd.	18 oz.	54 in.
997593	DT6	Luna Silver Sage	22 x 22	60 yd.	18.7 oz.	54 in.
997591	XUN	Luna Straw	22 x 22	60 yd.	18.7 oz.	54 in.
997714	NG3	Montego	25 x 20	60 yd.	18.9 oz.	54 in.
997592	ET2	Napa Brindle	22 x 22	60 yd.	18.7 oz.	54 in.
997524	AB8	Natural	25 x 25	60 yd.	22 oz.	54 in.
997522	AB9	Paja	25 x 25	60 yd.	22 oz.	54 in.
997525	XFG	Plata	25 x 25	60 yd.	21.1 oz.	54 in.
997722	LDD	Pria Tweed Indigo	25 x 25	60 yd.	21.1 oz.	54 in.
997724	NN6	Pria Tweed Sterling	25 x 25	60 yd.	21.1 oz.	54 in.
997710	KV6	Pritchard Ember	25 x 25	60 yd.	21.1 oz.	54 in.
997530	DW6	Reflection Seaglass	25 x 25	60 yd.	21.1 oz.	54 in.
997533	YCD	Reflection Taupe	25 x 25	60 yd.	21.1 oz.	54 in.
997704	EY6	Rivercane Spice	25 x 25	60 yd.	21.1 oz.	54 in.
997490	NS5	Rumi Latte Pearl	25 x 22	60 yd.	20 oz.	54 in.
997532	YCC	Saddle Stitch	22 x 18	60 yd.	17.2 oz.	54 in.
997706	XZT	Shelburne Taupe	25 x 22	60 yd.	20 oz.	54 in.
997488	LDY	Shelby Cadet Blue	22 x 22	60 yd.	18.7 oz.	54 in.
997492	DAX	Sisal Aloe	30 x 30	60 yd.	24.6 oz.	54 in.
997491	LEC	Sisal Winter Blue	30 x 30	60 yd.	24.6 oz.	54 in.
997518	OOV	Sisal/Aluminum	25 x 25	60 yd.	22 oz.	54 in.
997514	AKO	Sisal/Tungsten	25 x 25	60 yd.	22 oz.	54 in.
997489	LDZ	Terrace Poolside	22 x 22	60 yd.	18.7 oz.	54 in.
997590	KP4	Terrance Sienna	22 x 22	60 yd.	18.7 oz.	54 in.
997717	NG6	Tiki Butter	25 x 20	60 yd.	17.7 oz.	54 in.
997718	NG7	Tiki Glow	25 x 20	60 yd.	17.7 oz.	54 in.
997523	DB1	Turquesa	25 x 25	60 yd.	21.1 oz.	54 in.
997595	DR6	Veranda Basil	25 x 20	60 yd.	18.9 oz.	54 in.
997596	EM9	Veranda Nutmeg	25 x 20	60 yd.	18.9 oz.	54 in.
997521	DB2	Verde	25 x 25	60 yd.	21.1 oz.	54 in.
997716	NG5	Watercolor Tweed Glow	25 x 25	60 yd.	21.1 oz.	54 in.
997702	EX8	Watercolor Tweed Mocha	22 x 22	60 yd.	18.7 oz.	54 in.
997701	EX7	Watercolor Tweed Moth	22 x 22	60 yd.	18.7 oz.	54 in.
997700	OGA	Watercolor Tweed Oyster	22 x 22	60 yd.	18 oz.	54 in.
997719	NG8	Watercolor Tweed Pearly	25 x 25	60 yd.	21.1 oz.	54 in.

Phifertex® is a registered trademark of Phifer Inc. Microban® is a registered trademark of Microban Products Company. GREENGUARD® is a registered trademark of GREENGUARD Environmental Institute. Trivantage® is a registered trademark of Glen Raven, Inc.



Phifertex® Jacquards

Phifertex Jacquard is a 100% PVC fabric designed for use in sling applications. These fabrics are durable, antimicrobial, stain-resistant and fade-resistant, and can be woven into a # of combinations of colors and patterns.

Phifertex is infused with Microban® antimicrobial product protection, helping to provide an additional level of cleanliness protection that won't wash or wear away for the lifetime of the fabric. Microban protection inhibits the growth of stain and odor-causing bacteria, mold and mildew and works continuously, keeping fabrics cleaner for longer. This product is GREENGUARD® certified for low chemical emissions. UL.Com/GG, UL2818.

FABRIC	Vinyl Encapsulated Polyester Yarns
FR STANDARDS MET	California Technical Bulletin 117, Section E
WARRANTY	3-Year

ITEM #	STYLE #	COLOR	FABRIC COUNT	PUT UP	WEIGHT	WIDTH
997421	NC1	Burmese Java	42 x 14	60 yd.	15.7 oz.	54 in.
997417	DW7	Burmese Sea Mist	42 x 14	60 yd.	15.7 oz.	54 in.
997416	00U	Caribbean Palm	42 x 14	60 yd.	15.7 oz.	54 in.
997422	YCB	Dazzle Driftwood	42 x 14	60 yd.	15.7 oz.	54 in.
997478	NN8	Dresden Stone	42 x 14	60 yd.	16.2 oz.	54 in.
997400	NH2	Fantasy Flow Asher	42 x 14	60 yd.	15.7 oz.	54 in.
997283	EH2	Grasscloth Bronze	30 x 14	60 yd.	11.7 oz.	54 in.
997246	CN0	Grasscloth Natural	30 x 14	60 yd.	11.7 oz.	54 in.
997401	YEA	Greek Key Lattice	42 x 14	60 yd.	16.2 oz.	54 in.
997469	EM7	Island Palms Sadat	42 x 14	60 yd.	15.7 oz.	54 in.
997477	LDF	Lattice Greystone	42 x 14	60 yd.	15.7 oz.	54 in.
997496	LEF	Merge Blue Ombre	42 x 16	60 yd.	16.2 oz.	54 in.
997476	LDF	Pompass Grass Indigo	42 x 14	60 yd.	15.7 oz.	54 in.
997420	NB9	Seagrass Ash	42 x 14	60 yd.	15.7 oz.	54 in.
997480	0EN	Shantung White	42 x 20	60 yd.	17.6 oz.	54 in.
997271	C03	Straw Mat/Cognac	42 x 14	60 yd.	15.7 oz.	54 in.
997414	DW4	Sumba Aloe	42 x 14	60 yd.	15.7 oz.	54 in.
997419	NB8	Sumba Java	42 x 14	60 yd.	15.7 oz.	54 in.
997407	969	Sumba/Mocha	42 x 14	60 yd.	15.7 oz.	54 in.
997412	0AG	Tropic Foliage	42 x 14	60 yd.	15.7 oz.	54 in.
997251	GP8	Valencia/Blue	30 x 14	60 yd.	11.7 oz.	54 in.
997495	YGF	Victoria Polished Silver	42 x 16	60 yd.	16.2 oz.	54 in.
997205	Z44	Wild Orchid Black	42 x 14	60 yd.	15.5 oz.	54 in.

Phifertex® is a registered trademark of Phifer Inc. Microban® is a registered trademark of Microban Products Company. GREENGUARD® is a registered trademark of GREENGUARD Environmental Institute.

Phifertex® Olefin/PVC Blend

Suitable for both sling and cushion furniture applications, Phifertex Olefin/PVC blend fabric combines the durability of vinyl-coated polyester yarns with the softness of acrylic yarns. These fabrics are durable, antimicrobial, stain-resistant and fade-resistant, and can be woven into a # of combinations of colors and patterns.

Phifertex is infused with Microban® antimicrobial product protection, helping to provide an additional level of cleanliness protection that won't wash or wear away for the lifetime of the fabric. Microban protection inhibits the growth of stain and odor-causing bacteria, mold and mildew and works continuously, keeping fabrics cleaner for longer. This product is GREENGUARD® certified for low chemical emissions. UL.Com/GG, UL2818.

FABRIC	Vinyl Encapsulated Polyester/Olefin Blend Yarns
FR STANDARDS MET	California Technical Bulletin 117, Section E
WARRANTY	3-Year

ITEM #	STYLE #	COLOR	FABRIC COUNT	PUT UP	WEIGHT	WIDTH
997376	BJ4	Chambray Stripe	42 x 24	60 yd.	13.6 oz.	54 in.
997388	BR9	China Brush	42 x 24	60 yd.	13.6 oz.	54 in.
997319	NC4	Crystal Linen Ash	42 x 24	60 yd.	13.6 oz.	54 in.
997318	NC3	Crystal Linen Java	42 x 14	60 yd.	11.5 oz.	54 in.
997483	KY2	Domick Cedar	42 x 24	60 yd.	17.7 oz.	54 in.
997656	XZZ	Double Cross Limestone	42 x 24	60 yd.	13.6 oz.	54 in.
997484	LDG	Greer Indigo	42 x 24	60 yd.	13.6 oz.	54 in.
997317	NB6	Hayden Hickory	42 x 24	60 yd.	17.7 oz.	54 in.
997457	KQ4	Island Stripe Sienna	42 x 24	60 yd.	13.6 oz.	54 in.
997453	NH1	Kipton Suede	42 x 24	60 yd.	17.7 oz.	54 in.
997459	DZ8	Laird Sage	42 x 24	60 yd.	13.6 oz.	54 in.
997458	DZ7	Laird Willow	42 x 24	60 yd.	13.6 oz.	54 in.
997320	YCA	Milano Haze	42 x 24	60 yd.	13.9 oz.	54 in.
997653	EY3	Mingle Pecan	42 x 24	60 yd.	17.7 oz.	54 in.
997381	BS8	Natural Brush Forest Abbey	42 x 24	60 yd.	13.6 oz.	54 in.
997387	XHX	Natural Brush Forest Pebble	42 x 24	60 yd.	13.6 oz.	54 in.
997450	KW4	Patina Red	42 x 24	60 yd.	17.7 oz.	54 in.
997451	LBW	Patina Seashore	42 x 24	60 yd.	17.7 oz.	54 in.
997452	NG9	Patina Stone	42 x 24	60 yd.	17.7 oz.	54 in.
997375	BJ3	Raffia Natural	42 x 22	60 yd.	12.5 oz.	54 in.
997655	EY4	Raffia Pecan	42 x 24	60 yd.	13.6 oz.	54 in.
997485	LEE	Vegas Blues	42 x 20	60 yd.	16.0 oz.	54 in.
997305	XXS	Weston Charcoal	42 x 24	60 yd.	13.6 oz.	54 in.
997304	DT5	Weston Heather	42 x 24	60 yd.	13.6 oz.	54 in.

Phifertex® is a registered trademark of Phifer Inc. Microban® is a registered trademark of Microban Products Company. GREENGUARD® is a registered trademark of GREENGUARD Environmental Institute.



Sunbrella® Awning/Marine Solids 46 in.

A favorite for awning and marine use, Sunbrella fabric offers excellent fade and weather resistance. The fabric is water repellent, yet is also soft and easy to work with. A wide selection of colors and patterns are available to choose from, and also coordinate with Sunbrella upholstery fabrics. Sunbrella makes it easy to create beautiful designs that outperform the elements.

FABRIC	Sunbrella Acrylic
FINISH	Fluorocarbon
FR STANDARDS MET	California Technical Bulletin 117-2013 Class 1
WARRANTY	10-Year

ITEM #	STYLE #	COLOR	PUT UP	WEIGHT	WIDTH
874655	4655-0000	Alpine	65 yd.	9 oz.	46 in.
874623	4623-0000	Aquamarine	65 yd.	9 oz.	46 in.

ITEM #	STYLE #	COLOR	PUT UP	WEIGHT	WIDTH
874612	4612-0000	Aruba	65 yd.	9 oz.	46 in.
874668	4668-0000	Aspen	65 yd.	9 oz.	46 in.
874688	4688-0000	Basil	65 yd.	9 oz.	46 in.
874620	4620-0000	Beige	65 yd.	9 oz.	46 in.
874608	4608-0000	Black	65 yd.	9 oz.	46 in.
874640	4640-0000	Black Cherry	65 yd.	9 oz.	46 in.
874631	4631-0000	Burgundy	65 yd.	9 oz.	46 in.
874635	4635-0000	Buttercup	65 yd.	9 oz.	46 in.
874630	4630-0000	Cadet Grey	65 yd.	9 oz.	46 in.
874675	4675-0000	Capri	65 yd.	9 oz.	46 in.
874646	4646-0000	Captain Navy	65 yd.	9 oz.	46 in.
874644	4644-0000	Charcoal Grey	65 yd.	9 oz.	46 in.
874607	4607-0000	Charcoal Tweed	65 yd.	9 oz.	46 in.
874676	4676-0000	Cocoa	65 yd.	9 oz.	46 in.
874665	4665-0000	Concord	65 yd.	9 oz.	46 in.
874662	4662-0000	Crest Ash	65 yd.	9 oz.	46 in.
874660	4660-0000	Crest Birch	65 yd.	9 oz.	46 in.
874561	4661-0000	Crest Denim	65 yd.	9 oz.	46 in.
874606	4606-0000	Dubonnet Tweed	65 yd.	9 oz.	46 in.
874600	4600-0000	Erin Green	65 yd.	9 oz.	46 in.
874671	4671-0000	Fern	65 yd.	9 oz.	46 in.
874637	4637-0000	Forest Green	65 yd.	9 oz.	46 in.
874685	4685-0000	Ginkgo	65 yd.	9 oz.	46 in.
874672	4672-0000	Heather Beige	65 yd.	9 oz.	46 in.
874605	4605-0000	Hemlock Tweed	65 yd.	9 oz.	46 in.
874663	4663-0000	Hyacinth	65 yd.	9 oz.	46 in.
874532	4632-0000	Ivy	65 yd.	9 oz.	46 in.
874603	4603-0000	Jockey Red	65 yd.	9 oz.	46 in.
874633	4633-0000	Linen	65 yd.	9 oz.	46 in.
874654	4654-0000	Linen Tweed	65 yd.	9 oz.	46 in.
874666	4666-0000	Logo Red	65 yd.	9 oz.	46 in.
874667	4667-0000	Mahogany	65 yd.	9 oz.	46 in.
874678	4678-0000	Marine Blue	65 yd.	9 oz.	46 in.
874652	4652-0000	Mediterranean Blue	65 yd.	9 oz.	46 in.
874653	4653-0000	Mediterranean Blue Tweed	65 yd.	9 oz.	46 in.
875701	4701-0000	Mix Emerald	65 yd.	9 oz.	46 in.
875700	4700-0000	Mix Redwood	65 yd.	9 oz.	46 in.
874616	4616-0000	Mocha Tweed	65 yd.	9 oz.	46 in.
874604	4604-0000	Natural	65 yd.	9 oz.	46 in.
874626	4626-0000	Navy	65 yd.	9 oz.	46 in.
874686	4686-0000	Nutmeg	65 yd.	9 oz.	46 in.
874679	4679-0000	Ocean Blue	65 yd.	9 oz.	46 in.
874609	4609-0000	Orange	65 yd.	9 oz.	46 in.
874642	4642-0000	Oyster	65 yd.	9 oz.	46 in.
874601	4601-0000	Pacific Blue	65 yd.	9 oz.	46 in.
874683	4683-0000	Parchment	65 yd.	9 oz.	46 in.
874643	4643-0000	Persian Green	65 yd.	9 oz.	46 in.
874617	4617-0000	Royal Blue Tweed	65 yd.	9 oz.	46 in.
874689	4689-0000	Rust	65 yd.	9 oz.	46 in.

ITEM #	STYLE #	COLOR	PUT UP	WEIGHT	WIDTH
874641	4641-0000	Sapphire Blue	65 yd.	9 oz.	46 in.
874664	4664-0000	Sea	65 yd.	9 oz.	46 in.
874645	4645-0000	Seagrass Green	65 yd.	9 oz.	46 in.
874858	4858-0000	Silica Barley	65 yd.	9 oz.	46 in.
874897	4897-0000	Silica Charcoal	65 yd.	9 oz.	46 in.
874859	4859-0000	Silica Dune	65 yd.	9 oz.	46 in.
874896	4896-0000	Silica Sage	65 yd.	9 oz.	46 in.
874860	4860-0000	Silica Sesame	65 yd.	9 oz.	46 in.
874862	4862-0000	Silica Silver	65 yd.	9 oz.	46 in.
874861	4861-0000	Silica Stone	65 yd.	9 oz.	46 in.
874651	4651-0000	Silver	65 yd.	9 oz.	46 in.
874624	4624-0000	Sky Blue	65 yd.	9 oz.	46 in.
874684	4684-0000	Slate	65 yd.	9 oz.	46 in.
874615	4615-0000	Smoke	65 yd.	9 oz.	46 in.
874673	4673-0000	Spa	65 yd.	9 oz.	46 in.
874602	4602-0000	Sunflower Yellow	65 yd.	9 oz.	46 in.
874614	4614-0000	Tan	65 yd.	9 oz.	46 in.
874648	4648-0000	Taupe	65 yd.	9 oz.	46 in.
874622	4622-0000	Terracotta	65 yd.	9 oz.	46 in.
874628	4628-0000	Toast	65 yd.	9 oz.	46 in.
874696	4696-0000	Tresco Birch	65 yd.	9 oz.	46 in.
874658	4658-0000	Tresco Brass	65 yd.	9 oz.	46 in.
874699	4699-0000	Tresco Brick	65 yd.	9 oz.	46 in.
874698	4698-0000	Tresco Clay	65 yd.	9 oz.	46 in.
874697	4697-0000	Tresco Ginger	65 yd.	9 oz.	46 in.
874695	4695-0000	Tresco Linen	65 yd.	9 oz.	46 in.
874621	4621-0000	True Brown	65 yd.	9 oz.	46 in.
874610	4610-0000	Turquoise	65 yd.	9 oz.	46 in.
874677	4677-0000	Tuscan	65 yd.	9 oz.	46 in.
874618	4618-0000	Walnut Brown Tweed	65 yd.	9 oz.	46 in.
874674	4674-0000	Wheat	65 yd.	9 oz.	46 in.

Sunbrella® is a registered trademark of Glen Raven, Inc.



Sunbrella® Awning/Marine Solids 60 in.

A favorite for awning and marine use, Sunbrella fabric offers excellent fade and weather resistance. The fabric is water repellent, yet is also soft and easy to work with. A wide selection of colors and patterns are available to choose from, and also coordinate with Sunbrella upholstery fabrics. Sunbrella makes it easy to create beautiful designs that outperform the elements.

FABRIC	Sunbrella Acrylic
FINISH	Fluorocarbon
FR STANDARDS MET	California Technical Bulletin 117-2013 Class 1
WARRANTY	10-Year

ITEM #	STYLE #	COLOR	PUT UP	WEIGHT	WIDTH
721789	6055-0000	Alpine	65 yd.	9 oz.	60 in.
721760	6023-0000	Aquamarine	65 yd.	9 oz.	60 in.
721766	6012-0000	Aruba	65 yd.	9 oz.	60 in.
721802	6068-0000	Aspen	65 yd.	9 oz.	60 in.
721824	6088-0000	Basil	65 yd.	9 oz.	60 in.
721790	6020-0000	Beige	65 yd.	9 oz.	60 in.
721755	6008-0000	Black	65 yd.	9 oz.	60 in.
721774	6040-0000	Black Cherry	65 yd.	9 oz.	60 in.
721765	6031-0000	Burgundy	65 yd.	9 oz.	60 in.
721770	6035-0000	Buttercup	65 yd.	9 oz.	60 in.
721764	6030-0000	Cadet Grey	65 yd.	9 oz.	60 in.
721809	6075-0000	Capri	65 yd.	9 oz.	60 in.
721780	6046-0000	Captain Navy	65 yd.	9 oz.	60 in.
721778	6044-0000	Charcoal Grey	65 yd.	9 oz.	60 in.
721747	6007-0000	Charcoal Tweed	65 yd.	9 oz.	60 in.
721810	6076-0000	Cocoa	65 yd.	9 oz.	60 in.
721799	6065-0000	Concord	65 yd.	9 oz.	60 in.
721754	6006-0000	Dubonnet Tweed	65 yd.	9 oz.	60 in.
721745	6000-0000	Erin Green	65 yd.	9 oz.	60 in.
721805	6071-0000	Fern	65 yd.	9 oz.	60 in.
721771	6037-0000	Forest Green	65 yd.	9 oz.	60 in.
721821	6085-0000	Ginkgo	65 yd.	9 oz.	60 in.
721806	6072-0000	Heather Beige	65 yd.	9 oz.	60 in.
721753	6005-0000	Hemlock Tweed	65 yd.	9 oz.	60 in.

ITEM #	STYLE #	COLOR	PUT UP	WEIGHT	WIDTH
721832	6032-0000	Ivy	65 yd.	9 oz.	60 in.
721751	6003-0000	Jockey Red	65 yd.	9 oz.	60 in.
721767	6033-0000	Linen	65 yd.	9 oz.	60 in.
721788	6054-0000	Linen Tweed	65 yd.	9 oz.	60 in.
721800	6066-0000	Logo Red	65 yd.	9 oz.	60 in.
721801	6067-0000	Mahogany	65 yd.	9 oz.	60 in.
721812	6078-0000	Marine Blue	65 yd.	9 oz.	60 in.
721786	6052-0000	Mediterranean Blue	65 yd.	9 oz.	60 in.
721787	6053-0000	Mediterranean Blue Tweed	65 yd.	9 oz.	60 in.
721743	6016-0000	Mocha Tweed	65 yd.	9 oz.	60 in.
721752	6004-0000	Natural	65 yd.	9 oz.	60 in.
721762	6026-0000	Navy	65 yd.	9 oz.	60 in.
721822	6086-0000	Nutmeg	65 yd.	9 oz.	60 in.
721813	6079-0000	Ocean Blue	65 yd.	9 oz.	60 in.
721741	6009-0000	Orange	65 yd.	9 oz.	60 in.
721776	6042-0000	Oyster	65 yd.	9 oz.	60 in.
721750	6001-0000	Pacific Blue	65 yd.	9 oz.	60 in.
721817	6083-0000	Parchment	65 yd.	9 oz.	60 in.
721777	6043-0000	Persian Green	65 yd.	9 oz.	60 in.
721757	6017-0000	Royal Blue Tweed	65 yd.	9 oz.	60 in.
721739	2079-0060	Royal Navy	65 yd.	9 oz.	60 in.
721825	6089-0000	Rust	65 yd.	9 oz.	60 in.
721768	6027-0000	Salmon	65 yd.	9 oz.	60 in.
721775	6041-0000	Sapphire Blue	65 yd.	9 oz.	60 in.
721779	6045-0000	Seagrass Green	65 yd.	9 oz.	60 in.
721785	6051-0000	Silver	65 yd.	9 oz.	60 in.
721761	6024-0000	Sky Blue	65 yd.	9 oz.	60 in.
721818	6084-0000	Slate	65 yd.	9 oz.	60 in.
721815	6015-0000	Smoke	65 yd.	9 oz.	60 in.
721807	6073-0000	Spa	65 yd.	9 oz.	60 in.
721746	6002-0000	Sunflower Yellow	65 yd.	9 oz.	60 in.
721742	6014-0000	Tan	65 yd.	9 oz.	60 in.
721782	6048-0000	Taupe	65 yd.	9 oz.	60 in.
721784	6050-0000	Teal Tweed	65 yd.	9 oz.	60 in.
721744	6022-0000	Terracotta	65 yd.	9 oz.	60 in.
721763	6028-0000	Toast	65 yd.	9 oz.	60 in.
721872	2389-0060	Toast Tweed	65 yd.	9 oz.	60 in.
721827	6096-0000	Tresco Birch	65 yd.	9 oz.	60 in.
721795	6058-0000	Tresco Brass	65 yd.	9 oz.	60 in.
721830	6099-0000	Tresco Brick	65 yd.	9 oz.	60 in.
721829	6098-0000	Tresco Clay	65 yd.	9 oz.	60 in.
721828	6097-0000	Tresco Ginger	65 yd.	9 oz.	60 in.
721814	6094-0000	Tresco Indigo	65 yd.	9 oz.	60 in.
721826	6095-0000	Tresco Linen	65 yd.	9 oz.	60 in.
721759	6021-0000	True Brown	65 yd.	9 oz.	60 in.
721748	6010-0000	Turquoise	65 yd.	9 oz.	60 in.
721811	6077-0000	Tuscan	65 yd.	9 oz.	60 in.
721758	6018-0000	Walnut Brown Tweed	65 yd.	9 oz.	60 in.
721808	6074-0000	Wheat	65 yd.	9 oz.	60 in.

Sunbrella® is a registered trademark of Glen Raven, Inc.

STANDARD MARINE STYLES

(Courtesy of The Marine Fabricators Association)

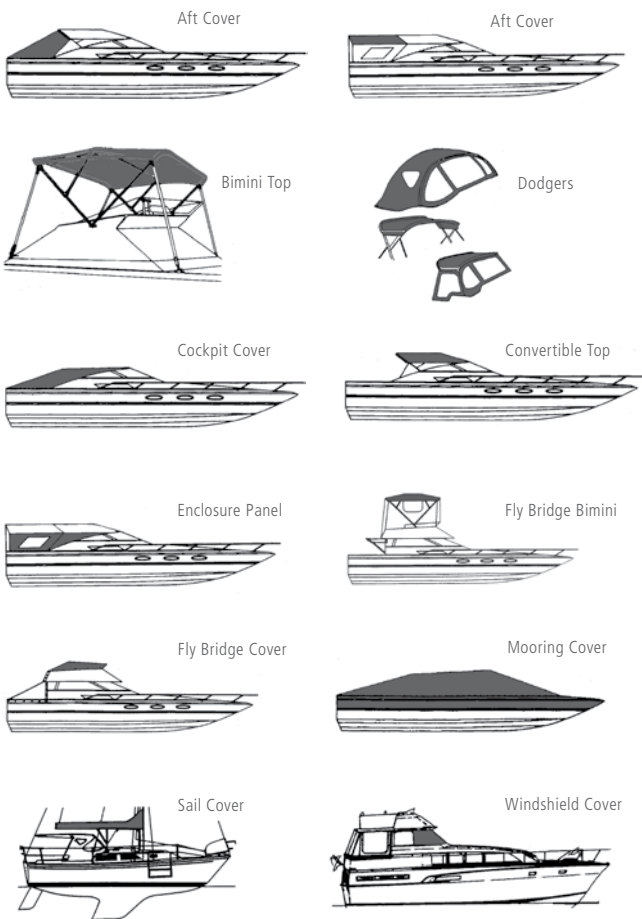

(Courtesy of The Marine Fabricators Association)

Sunbrella® Awning/Marine Solids 80 in.

A favorite for awning and marine use, Sunbrella fabric offers excellent fade and weather resistance. The fabric is water repellent, yet is also soft and easy to work with. A wide selection of colors and patterns are available to choose from, and also coordinate with Sunbrella upholstery fabrics. Sunbrella makes it easy to create beautiful designs that outperform the elements.

FABRIC	Sunbrella Acrylic
FINISH	Fluorocarbon
FR STANDARDS MET	California Technical Bulletin 117-2013 Class 1
WARRANTY	10-Year

ITEM #	STYLE #	COLOR	PUT UP	WEIGHT	WIDTH
722308	80008-0000	Black	50 yd.	9 oz.	80 in.
722331	80031-0000	Burgundy	50 yd.	9 oz.	80 in.
722330	80030-0000	Cadet Grey	50 yd.	9 oz.	80 in.
722346	80046-0000	Captain Navy	50 yd.	9 oz.	80 in.
722337	80037-0000	Forest Green	50 yd.	9 oz.	80 in.
722301	80001-0000	Pacific Blue	50 yd.	9 oz.	80 in.
722328	80028-0000	Toast	50 yd.	9 oz.	80 in.

Sunbrella® is a registered trademark of Glen Raven, Inc.



Sunbrella® Plus 60 in.

Sunbrella Plus is a traditional Sunbrella awning and marine fabric with a durable polyurethane undercoating for superior water resistance. Sunbrella Plus uses standard Sunbrella colors for easy color coordination and is ideal wherever water resistance is essential.

FABRIC	Sunbrella Acrylic
FINISH	Face- Fluorocarbon, Back- Polyurethane
FR STANDARDS MET	California Technical Bulletin 117-2013 Class 1
WARRANTY	5-Year

ITEM #	STYLE #	COLOR	PUT UP	WEIGHT	WIDTH
728423	8423-0000	Aquamarine	60 yd.	10 oz.	60 in.
728408	8408-0000	Black	60 yd.	10 oz.	60 in.
728431	8431-0000	Burgundy	60 yd.	10 oz.	60 in.
728430	8430-0000	Cadet Grey	60 yd.	10 oz.	60 in.
728446	8446-0000	Captain Navy	60 yd.	10 oz.	60 in.
728406	8406-0000	Dubonnet Tweed	60 yd.	10 oz.	60 in.
728437	8437-0000	Forest Green	60 yd.	10 oz.	60 in.
728403	8403-0000	Jockey Red	60 yd.	10 oz.	60 in.
728404	8404-0000	Natural	60 yd.	10 oz.	60 in.
728442	8442-0000	Oyster	60 yd.	10 oz.	60 in.
728401	8401-0000	Pacific Blue	60 yd.	10 oz.	60 in.
728443	8443-0000	Persian Green	60 yd.	10 oz.	60 in.
728417	8417-0000	Royal Blue Tweed	60 yd.	10 oz.	60 in.
728428	8428-0000	Toast	60 yd.	10 oz.	60 in.

Sunbrella® is a registered trademark of Glen Raven, Inc.



Sunbrella® Supreme

Sunbrella Supreme is a luxurious, waterproof exterior marine fabric featuring Sunbrella canvas on the exterior face and a special Sunbrella flocking on the reverse side. The unique bonding process creates a waterproof Sunbrella canvas with a beautifully soft headliner underneath.

FABRIC	Sunbrella Acrylic
FINISH	Fluorocarbon
FR STANDARDS MET	California Technical Bulletin 117-2013 Class 1
WARRANTY	5-Year

ITEM #	STYLE #	COLOR	PUT UP	WEIGHT	WIDTH
722203	9408-0000	Black/Black	40 yd.	12.5 oz.	60 in.
722204	9408-0001	Black/Linen	40 yd.	12.5 oz.	60 in.
722215	9446-0000	Captain Navy/Captain Navy	40 yd.	12.5 oz.	60 in.
722216	9446-0001	Captain Navy/Linen	40 yd.	12.5 oz.	60 in.
722212	9433-0000	Linen/Linen	40 yd.	12.5 oz.	60 in.

Sunbrella® is a registered trademark of Glen Raven, Inc.

Sunbrella® Plus 80 in.

Sunbrella Plus is a traditional Sunbrella awning and marine fabric with a durable polyurethane undercoating for superior water resistance. Sunbrella Plus uses standard Sunbrella colors for easy color coordination and is ideal wherever water resistance is essential.

FABRIC	Sunbrella Acrylic
FINISH	Face- Fluorocarbon, Back- Polyurethane
FR STANDARDS MET	California Technical Bulletin 117-2013 Class 1
WARRANTY	5-Year

ITEM #	STYLE #	COLOR	PUT UP	WEIGHT	WIDTH
728508	84008-0000	Black	50 yd.	10 oz.	80 in.
728531	84031-0000	Burgundy	50 yd.	10 oz.	80 in.
728530	84030-0000	Cadet Grey	50 yd.	10 oz.	80 in.
728546	84046-0000	Captain Navy	50 yd.	10 oz.	80 in.
728501	84001-0000	Pacific Blue	50 yd.	10 oz.	80 in.
728528	84028-0000	Toast	50 yd.	10 oz.	80 in.

Sunbrella® is a registered trademark of Glen Raven, Inc.

Aqualon® Edge

Aqualon Edge is a new product from Trivantage®, featuring Perfecta Marine® technology. Aqualon Edge with Perfecta Marine technology provides superior heat reduction and heat reflection, and exceptional UV performance. Featuring innovative technology and these enhanced benefits, Trivantage offers an industry leading 7-year warranty for this hybrid coated fabric.

FABRIC	Two-Ply Polyester Duck
FINISH	Vinyl Resin Top Coated with Underside Coated with a Durable Water Resistant Finish
WARRANTY	7-Year

ITEM #	STYLE #	COLOR	PUT UP	WEIGHT	WIDTH
776217	5917	Alpine White	65 yd.	8.75 oz.	60 in.
776207	5907	Apple Red	65 yd.	8.75 oz.	60 in.
776244	5944	Atlantic Blue	65 yd.	8.75 oz.	60 in.
776268	5968	Basic Beige	65 yd.	8.75 oz.	60 in.
776200	5900	Black Onyx	65 yd.	8.75 oz.	60 in.
776209	5909	Cabernet	65 yd.	8.75 oz.	60 in.
776218	5900	Charcoal Grey	65 yd.	8.75 oz.	60 in.
776213	5913	Cherry Red	65 yd.	8.75 oz.	60 in.
776242	5942	Classic Silver	65 yd.	8.75 oz.	60 in.
776208	5908	Coastal Ivory	65 yd.	8.75 oz.	60 in.
776269	5969	Indigo Blue	65 yd.	8.75 oz.	60 in.
776203	5903	Ivy Green	65 yd.	8.75 oz.	60 in.
776221	5921	Mountain Taupe	65 yd.	8.75 oz.	60 in.
776228	5928	Nautical Navy	65 yd.	8.75 oz.	60 in.
776225	5925	Oxford Tan	65 yd.	8.75 oz.	60 in.
776205	5900	Scarlet	65 yd.	8.75 oz.	60 in.
776271	5971	Slate Grey	65 yd.	8.75 oz.	60 in.
776249	5949	Toast	65 yd.	8.75 oz.	60 in.
776212	5912	True Blue	65 yd.	8.75 oz.	60 in.
776204	5904	True Teal	65 yd.	8.75 oz.	60 in.

Aqualon® and Trivantage® are registered trademarks of Glen Raven, Inc. Perfecta Marine® is a registered trademark of Graniteville Specialty Fabrics.

Harbor-Time®

Harbor-Time is designed for use in various marine and industrial applications. Its unique color, enhanced with a proprietary clear coating on both sides has exceptional abrasion resistance. Stabilized for minimum stretch or shrinkage will ensure continuous fit throughout application. This highly water repellent, mildew and UV resistant fabric has superior strength and long-lasting color.

Because Harbor-Time is water repellent, the use of vents when fabricating a mooring cover is recommended. A clear vinyl patch should be sewn at contact points when total protection against rub-off is desired. This fabric is non-flame retardant, and should not be exposed to direct flame or extreme heat.

FABRIC	Polyester
FINISH	Acrylic Coated
WARRANTY	5-Year

ITEM #	STYLE #	COLOR	PUT UP	WEIGHT	WIDTH
775655	HT025	Antique Beige	50 yd.	11 oz.	62 in.
775664	HT034	Beige Suede	50 yd.	11 oz.	62 in.
775668	HT042	Cardinal Red	50 yd.	11 oz.	62 in.
775651	HT021	Cordovan	50 yd.	11 oz.	62 in.
775638	HT008	Driftwood	50 yd.	11 oz.	62 in.
775662	HT032	Mallard Green	50 yd.	11 oz.	62 in.
775657	HT027	Nautical Blue	50 yd.	11 oz.	62 in.
775667	HT041	Navy	50 yd.	11 oz.	62 in.
775660	HT030	Onyx	50 yd.	11 oz.	62 in.
775648	HT018	Putty	50 yd.	11 oz.	62 in.
775653	HT023	Shale	50 yd.	11 oz.	62 in.
775652	HT022	Storm Grey	50 yd.	11 oz.	62 in.
775645	HT015	Surf	50 yd.	11 oz.	62 in.

Harbor-Time® is a registered trademark of Glen Raven, Inc.

Sea-Spraé®

Economical and super lightweight, Sea-Spraé is the perfect choice for lightweight bimini tops and other marine craft covers. The fabric resists water, dirt and UV rays, and is stabilized for minimum stretch and shrinkage. This durable fabric is flexible and easy to fabricate, and has excellent tear and tensile strength. Sea-Spraé features proprietary back coating to prevent color transfer, however, a clear vinyl patch should be sewn at contact points when total protection against rub-off is desired.

FABRIC	Polyester
FINISH	Acrylic Coated
WARRANTY	3-Year

ITEM #	STYLE #	COLOR	PUT UP	WEIGHT	WIDTH
775757	SEA27	Bay Blue	75 yd.	6.25 oz.	64 in.
775760	SEA30	Black	75 yd.	6.25 oz.	64 in.
775796	SEA96	Burgundy	75 yd.	6.25 oz.	64 in.
775762	SEA32	Dark Green	75 yd.	6.25 oz.	64 in.
775753	SEA23	Dark Grey	75 yd.	6.25 oz.	64 in.
775776	SEA46	Sandpiper Grey	75 yd.	6.25 oz.	64 in.
775755	SEA25	Toast	75 yd.	6.25 oz.	64 in.
775756	SEA26	White	75 yd.	6.25 oz.	64 in.

Sea-Spraé® is a registered trademark of Glen Raven, Inc.



SeaMark™

An exterior grade, waterproof burbank grain marine fabric. Made by combining Sunbrella® fabric with a textured marine grade vinyl. Ideal for boat tops and covers. Also used for tonneau and equipment covers.

FABRIC	Sunbrella Acrylic Bonded to Vinyl
FINISH	Top: Fluorocarbon Finish. Back: Textured Marine Grade Vinyl for Waterproof Finish.
WARRANTY	5-Year

ITEM #	STYLE #	COLOR	PUT UP	WEIGHT	WIDTH
727100	1002	Black	50 yd.	16 oz.	60 in.
727110	1131	Cadet Gray	50 yd.	16 oz.	60 in.
727175	1701	Captain Navy	50 yd.	16 oz.	60 in.
727145	6007	Charcoal Tweed	50 yd.	16 oz.	60 in.
727135	6006MDN	Dubonnet Tweed	50 yd.	16 oz.	60 in.
727170	1655	Forest Green	50 yd.	16 oz.	60 in.
727130	6005	Hemlock Tweed	50 yd.	16 oz.	60 in.
727153	1645	Jockey Red	50 yd.	16 oz.	60 in.
727106	Z11543	Linen	50 yd.	16 oz.	60 in.
727120	1543	Linen Tweed	50 yd.	16 oz.	60 in.
727190	1694	Mediterranean Blue Tweed	50 yd.	16 oz.	60 in.
727105	1008	Navy	50 yd.	16 oz.	60 in.
727165	1543	Oyster	50 yd.	16 oz.	60 in.
727125	2331	Pacific Blue	50 yd.	16 oz.	60 in.
727140	2331	Royal Blue Tweed	50 yd.	16 oz.	60 in.
727155	1511	Teal Tweed	50 yd.	16 oz.	60 in.
727107	1543	Toast Tweed	50 yd.	16 oz.	60 in.
727150	6006MUN	True Burgundy	50 yd.	16 oz.	60 in.

SeaMark™ is a trademark of the Haartz Corporation. Sunbrella® is a registered trademark of Glen Raven, Inc.

Sur Last®

Sur Last can be used for many applications that require UV protection, including boat covers, bimini tops, boat storage covers, furniture covers, tonneau covers, luggage, and camping enclosures just to name a few. Sur Last is a very colorfast protective material, and because it is solution-dyed, the colors will not fade or wash out. Sur Last stands up to wind, rain, pollutants and chemicals that will make other fabrics fade. It has high UV, mold and mildew resistance, excellent tear and abrasion resistance, and is non-abrasive to gelcoat and other popular marine finishes. Sur Last also features outstanding silk screen adhesion.

FABRIC	100% Solution Dyed Polyester
FINISH	3/4 oz. Urethane Back Coating
WARRANTY	3-Year

ITEM #	STYLE #	COLOR	PUT UP	WEIGHT	WIDTH
777166	3866	Admiral Navy	100 yd.	7 oz.	60 in.
777154	3854	Black	100 yd.	7 oz.	60 in.
777160	3860	Forest	100 yd.	7 oz.	60 in.
777162	3862	Light Grey	100 yd.	7 oz.	60 in.
777151	3851	Navy Weave	100 yd.	7 oz.	60 in.
777153	3853	Sand	100 yd.	7 oz.	60 in.
777169	3869	Scarlet	100 yd.	7 oz.	60 in.
777171	3871	Walnut	100 yd.	7 oz.	60 in.

Sur Last® is a registered trademark of Glen Raven, Inc.



Herculite® Riviera Marine Fabric™

Herculite Riviera Marine Fabric is specifically formulated with high quality vinyl that features a soft, supple hand for easy fabrication. Riviera is suited for a variety of marine applications, such as bimini tops, enclosure curtains, and cockpit and stationary boat covers.

Riviera is colorfast, mildew resistant and waterproof. The fabric's exclusive top coat provides ease of cleaning, prolongs the life of the fabric and adds to the fabric's pleasing appearance. Matching binding is available for all products.

FABRIC	100% PVC Composite Supported by a High Strength Woven Polyester
FINISH	Top Coat
WARRANTY	5-Year

ITEM #	STYLE #	COLOR	PUT UP	WEIGHT	WIDTH
975167	167	Ivory	50 yd.	15 oz.	61 in.
975165	166	Snow White	33 yd.	15 oz.	78 in.
975166	166	Snow White	50 yd.	15 oz.	61 in.
975164	168	White	33 yd.	15 oz.	78 in.
975168	168	White	50 yd.	15 oz.	61 in.

Herculite® is a registered trademark of Herculite Products Inc. Herculite Riviera Marine Fabric™ is a trademark of Herculite Products Inc.

Weblon® Regatta® Yacht Fabric

For all pleasure craft, power or sail, Weblon Regatta Yacht Fabric with Rain Kleen® finish provides the best answer for fabric accessories such as boom awnings, bimini, sun, curtains, dodgers, enclosures, cushions, mooring and protective covers.

Regatta Yacht Fabric is designed specifically for the rigorous topside exposure. This fabric is not for use for trailering covers.

Regatta is a lamination of two plies of specially formulated vinyl with an inner, reinforcing core fabric woven from high strength polyester. Regatta's exclusive Rain Kleen finish on the weather side provides ease of cleaning, prolongs the life of the fabric and adds to the pleasing appearance of the surface.

Regatta Offers You These Advantages:

- Waterproof and Mildew Resistant
- High, Lasting Strength – Lightweight
- Dimensional Stability
- Age, Stain and Fade Resistance
- Abrasion Resistance
- White Tops Reflect Heat – Pastel Linings Relieve Glare
- Wide Color Selection

FABRIC	Polyester
FINISH	Vinyl Laminated, Embossed Rain Kleen®
WARRANTY	5-Year

ITEM #	STYLE #	COLOR	PUT UP	WEIGHT	WIDTH
975625	D-62445	Black/Black	50 yd.	13 oz.	62 in.
975611	D-62439	Ivory/Ivory	50 yd.	13 oz.	62 in.
975529	D-62429	White/Driftwood	50 yd.	13 oz.	62 in.
975503	D-62416	White/Foam Green	50 yd.	13 oz.	62 in.
975502	D-62415	White/Mist Blue	50 yd.	13 oz.	62 in.
975501	D-62417	White/White	50 yd.	13 oz.	62 in.

Weight varies slightly from color to color. Weight and roll size nominal. These values are subject to slight variations and are NOT intended to be used as specifications.

Weblon®, Regatta® and Rain Kleen® are registered trademarks of Herculite Products Inc.



Stamoid® Marine Fabrics – Stamoid Light 59 in.

Stamoid vinyl coated polyester marine fabrics offer outstanding features for a wide range of exterior marine applications. Inherent dimensional stability provides long-lasting durability for boats of all sizes. Stamoid marine is colorfast, mildew resistant and waterproof. It maintains its flexibility in temperature extremes from the hot tropics to near zero temperatures. Stamoid's vinyl coating assures dirt resistance and cleanability.

Suggested uses: equipment cover, flybridge cover, furling sail cover, console cover, dinghy cover, shadesail.

FABRIC	High-Tenacity Polyester
FINISH	Vinyl Coated Top Side
WARRANTY	5-Year

ITEM #	STYLE #	COLOR	PUT UP	WEIGHT	WIDTH
742014	F4128	Black	54.7 yd.	8.3 oz.	59 in.
742001	F4128	Cream	54.7 yd.	8.3 oz.	59 in.
742002	F4128	Ivory	54.7 yd.	8.3 oz.	59 in.
742010	F4128	Navy	54.7 yd.	8.3 oz.	59 in.
742004	F4128	Pearl Grey	54.7 yd.	8.3 oz.	59 in.
742009	F4128	Royal Blue	54.7 yd.	8.3 oz.	59 in.
742003	F4128	Sand	54.7 yd.	8.3 oz.	59 in.
742005	F4128	Silver	54.7 yd.	8.3 oz.	59 in.
742013	F4128	Snow White	54.7 yd.	8.3 oz.	59 in.
742000	F4128	White	54.7 yd.	8.3 oz.	59 in.

Stamoid® is a registered trademark of The Serge Ferrari Group.

Stamoid® Marine Fabrics – Stamoid Light 80 in.

Stamoid vinyl coated polyester marine fabrics offer outstanding features for a wide range of exterior marine applications. Inherent dimensional stability provides long-lasting durability for boats of all sizes. Stamoid marine is colorfast, mildew resistant and waterproof. It maintains its flexibility in temperature extremes from the hot tropics to near zero temperatures. Stamoid's vinyl coating assures dirt resistance and cleanability.

Suggested uses: equipment cover, flybridge cover, furling sail cover, console cover, dinghy cover, shadesail.

FABRIC	High-Tenacity Polyester
FINISH	Vinyl Coated Top Side
WARRANTY	5-Year

ITEM #	STYLE #	COLOR	PUT UP	WEIGHT	WIDTH
742064	F4128	Snow White	32.8 yd.	8.3 oz.	80 in.
742050	F4128	White	32.8 yd.	8.3 oz.	80 in.

Stamoid® is a registered trademark of The Serge Ferrari Group.

Stamoid® Marine Fabrics – Stamoid Heavy Cover 102 in.

Stamoid vinyl coated polyester marine fabrics offer outstanding features for a wide range of exterior marine applications. Inherent dimensional stability provides long-lasting durability for boats of all sizes. Stamoid marine is colorfast, mildew resistant and waterproof. It maintains its flexibility in temperature extremes from the hot tropics to near zero temperatures. Stamoid's vinyl coating assures dirt resistance and cleanability.

Suggested uses: cockpit covers, protective covers, console covers.

FABRIC	High-Tenacity Polyester
FINISH	Vinyl Coated Top Side
WARRANTY	5-Year

ITEM #	STYLE #	COLOR	PUT UP	WEIGHT	WIDTH
742181	4313	Navy	33 yd.	14 oz.	102.36 in.
742184	4313	Pearl Grey	33 yd.	14 oz.	102.36 in.
742182	4313	Royal Blue	33 yd.	14 oz.	102.36 in.
742180	4313	White	33 yd.	14 oz.	102.36 in.

Stamoid® is a registered trademark of The Serge Ferrari Group.

Stamoid® Marine Fabrics – Stamoid Light 102 in.

Stamoid vinyl coated polyester marine fabrics offer outstanding features for a wide range of exterior marine applications. Inherent dimensional stability provides long-lasting durability for boats of all sizes. Stamoid marine is colorfast, mildew resistant and waterproof. It maintains its flexibility in temperature extremes from the hot tropics to near zero temperatures. Stamoid’s vinyl coating assures dirt resistance and cleanability.

Suggested uses: equipment cover, flybridge cover, furling sail cover, console cover, dinghy cover, shadesail.

FABRIC	High-Tenacity Polyester
FINISH	Vinyl Coated Top Side
WARRANTY	5-Year

ITEM #	STYLE #	COLOR	PUT UP	WEIGHT	WIDTH
742072	F4128	Black	32.8 yd.	8.3 oz.	102 in.
742073	F4128	Bordeaux	32.8 yd.	8.3 oz.	102 in.
742074	F4128	Charcoal	32.8 yd.	8.3 oz.	102 in.
742075	F4128	Cream	32.8 yd.	8.3 oz.	102 in.
742077	F4128	Ivory	32.8 yd.	8.3 oz.	102 in.
742078	F4128	Navy	32.8 yd.	8.3 oz.	102 in.
742079	F4128	Pearl Grey	32.8 yd.	8.3 oz.	102 in.
742080	F4128	Royal Blue	32.8 yd.	8.3 oz.	102 in.
742081	F4128	Sand	32.8 yd.	8.3 oz.	102 in.
742071	F4128	Snow White	32.8 yd.	8.3 oz.	102 in.
742082	F4128	Taupe	32.8 yd.	8.3 oz.	102 in.
742070	F4128	White	32.8 yd.	8.3 oz.	102 in.

Stamoid® is a registered trademark of The Serge Ferrari Group.

Stamoid® Marine Fabrics – Stamoid Open 102 in.

Stamoid vinyl coated polyester marine fabrics offer outstanding features for a wide range of exterior marine applications. Inherent dimensional stability provides long-lasting durability for boats of all sizes. Stamoid marine is colorfast, mildew resistant and waterproof. It maintains its flexibility in temperature extremes from the hot tropics to near zero temperatures. Stamoid’s vinyl coating assures dirt resistance and cleanability.

Suggested uses: bimini top, dodger, enclosure, boat awning.

FABRIC	High-Tenacity Polyester
FINISH	Vinyl Coated Both Sides
WARRANTY	5-Year

ITEM #	STYLE #	COLOR	PUT UP	WEIGHT	WIDTH
742173	F4463-10204	Cream	33 yd.	19.1 oz.	102.36 in.
742172	F4463	Ivory	33 yd.	19.1 oz.	102.36 in.
742170	F4463-10309	Snow White	33 yd.	19.1 oz.	102.36 in.
742171	F4463	White	33 yd.	19.1 oz.	102.36 in.

Stamoid® is a registered trademark of The Serge Ferrari Group.



Stamoid® Marine Fabrics – Stamoid Top 59 in.

Stamoid vinyl coated polyester marine fabrics offer outstanding features for a wide range of exterior marine applications. Inherent dimensional stability provides long-lasting durability for boats of all sizes. Stamoid marine is colorfast, mildew resistant and waterproof. It maintains its flexibility in temperature extremes from the hot tropics to near zero temperatures. Stamoid’s vinyl coating assures dirt resistance and cleanability.

Suggested uses: bimini top, dodger, enclosure, boat awning.

FABRIC	High-Tenacity Polyester
FINISH	Vinyl Coated Both Sides
WARRANTY	5-Year

ITEM #	STYLE #	COLOR	PUT UP	WEIGHT	WIDTH
742115	F3933	Black	54.7 yd.	12.7 oz.	59 in.
742114	F3933	Bordeaux	54.7 yd.	12.7 oz.	59 in.
742120	F3933-20168	Charcoal/White	54.7 yd.	12.7 oz.	59 in.
742101	F3933	Cream	54.7 yd.	12.7 oz.	59 in.
742118	F3933	Evergreen	54.7 yd.	12.7 oz.	59 in.
742102	F3933	Ivory	54.7 yd.	12.7 oz.	59 in.
742110	F3933	Navy	54.7 yd.	12.7 oz.	59 in.
742104	F3933	Pearl Grey	54.7 yd.	12.7 oz.	59 in.
742109	F3933	Royal Blue	54.7 yd.	12.7 oz.	59 in.
742103	F3933	Sand	54.7 yd.	12.7 oz.	59 in.
742113	F3933	Snow White	54.7 yd.	12.7 oz.	59 in.
742100	F3933	White	54.7 yd.	12.7 oz.	59 in.

Stamoid® is a registered trademark of The Serge Ferrari Group.

Stamoid® Marine Fabrics – Stamoid Top 80 in.

Stamoid vinyl coated polyester marine fabrics offer outstanding features for a wide range of exterior marine applications. Inherent dimensional stability provides long-lasting durability for boats of all sizes. Stamoid marine is colorfast, mildew resistant and waterproof. It maintains its flexibility in temperature extremes from the hot tropics to near zero temperatures. Stamoid’s vinyl coating assures dirt resistance and cleanability.

Suggested uses: bimini top, dodger, enclosure, boat awning.

FABRIC	High-Tenacity Polyester
FINISH	Vinyl Coated Both Sides
WARRANTY	5-Year

ITEM #	STYLE #	COLOR	PUT UP	WEIGHT	WIDTH
742164	F3933	Snow White	32.8 yd.	12.7 oz.	80 in.
742150	F3933	White	32.8 yd.	12.7 oz.	80 in.

Stamoid® is a registered trademark of The Serge Ferrari Group.

Stamoid® Marine Fabrics – Stamoid Top 102 in.

Stamoid vinyl coated polyester marine fabrics offer outstanding features for a wide range of exterior marine applications. Inherent dimensional stability provides long-lasting durability for boats of all sizes. Stamoid marine is colorfast, mildew resistant and waterproof. It maintains its flexibility in temperature extremes from the hot tropics to near zero temperatures. Stamoid’s vinyl coating assures dirt resistance and cleanability.

Suggested uses: bimini top, dodger, enclosure, boat awning.

FABRIC	High-Tenacity Polyester
FINISH	Vinyl Coated Both Sides
WARRANTY	5-Year

ITEM #	STYLE #	COLOR	PUT UP	WEIGHT	WIDTH
742167	F3933	Black	32.8 yd.	12.7 oz.	102 in.
742168	F3933	Cream	32.8 yd.	12.7 oz.	102 in.
742160	F3933	Pearl Grey	32.8 yd.	12.7 oz.	102 in.
742166	F3933	Snow White	32.8 yd.	12.7 oz.	102 in.
742165	F3933	White	32.8 yd.	12.7 oz.	102 in.

Stamoid® is a registered trademark of The Serge Ferrari Group.

Stamoid® Marine Fabrics – Pure

Stamoid Pure is a lightweight woven PVC material that offers colorfastness, compactness and exceptional service life. 100% waterproof. Applications include Bimini tops, T-tops, sprayhoods and covers for power or sail boats.

FABRIC	High-Tenacity Polyester
FINISH	2 sides PVC, Special Varish and Formulation Oil Resistant
WARRANTY	5-Year

ITEM #	STYLE #	COLOR	PUT UP	WEIGHT	WIDTH
742222	F3934-10204	Cream	54.7 yd.	12.64 oz.	59 in.
742221	F3934-10309	Snow White	54.7 yd.	12.64 oz.	59 in.
742220	F3934-03244	White	54.7 yd.	12.64 oz.	59 in.

Stamoid® is a registered trademark of The Serge Ferrari Group.

Super-Top™ Boat Topping

Premium grade diamond-embossed Super-Top is all weather ready on the top side, and backed with a soft gray “Denim” polyester/cotton fabric. Resists sun, mildew, water, grease and dirt. The soft vinyl and polyester/cotton blend makes it easier to fold, store and handle.

FABRIC	65% Polyester/35% Cotton Blend
FINISH	Vinyl Laminated, Embossed
WARRANTY	None

ITEM #	COLOR	PUT UP	WEIGHT	WIDTH
734452	Pearl White/Denim	40 yd.	16 oz.	54 in.

Super-Top™ is a trademark of Glen Raven, Inc.

Sunforger® Boat Shrink

A durable water-repellent and mildew-resistant fabric with an added feature – exposure shrinkage of approximately 3% or less under normal use. A popular fabric for use where normal water and moisture conditions exist.

FABRIC	Cotton Army Duck
FINISH	Water Repellent Finish

ITEM #	STYLE #	COLOR	PUT UP	WEIGHT	WIDTH
714045	698	Colorless	50 yd.	12.63 oz.	36 in.
714041	638	Colorless	50 yd.	10.1 oz.	36 in.
714021	538	Pearl Gray	50 yd.	10.1 oz.	36 in.
714024	598	Pearl Gray	50 yd.	12.63 oz.	36 in.

Sunforger® is a registered trademark of M.F. & H Textiles.

Sunforger® Boat Shrink – Flame Retardant

A durable water-repellent and mildew-resistant fabric with an added feature – exposure shrinkage of approximately 3% or less under normal use. A popular fabric for use where normal water and moisture conditions exist.

FABRIC	Cotton Army Duck
FINISH	Water Repellent Finish
FR STANDARDS MET	CPAI-84

ITEM #	STYLE #	COLOR	PUT UP	WEIGHT	WIDTH
714042	638	Colorless	50 yd.	10.1 oz.	36 in.
714183		Colorless	100 yd.	10.1 oz.	60 in.

Sunforger® is a registered trademark of M.F. & H Textiles.

Sunforger® Marine Finish Boat Shrunken

Where the ultimate is needed in water repellency and mildew resistance, use Marine Finish Boat Shrunken. Expect limited exposure shrinkage of approximately 3%, under normal use. Marine Finish contains a special added compound that gives greater water repellency and mildew resistance.

FABRIC	Cotton Army Duck				
FINISH	Water Repellent Finish				
ITEM #	STYLE #	COLOR	PUT UP	WEIGHT	WIDTH
714121	938	Colorless	50 yd.	10.1 oz.	36 in.
714124	998	Colorless	50 yd.	12.63 oz.	36 in.
714145	1098	Khaki	50 yd.	12.63 oz.	36 in.
714102	738	Pearl Gray	50 yd.	10.1 oz.	36 in.
714105	798	Pearl Gray	50 yd.	12.63 oz.	36 in.
714138		Pigment Dyed Gray	50 yd.	10.1 oz.	36 in.
714146		Pigment Dyed Gray	50 yd.	12.63 oz.	36 in.
714148	1198	Suntan	50 yd.	12.63 oz.	36 in.

Sunforger® is a registered trademark of M.F. & H Textiles.

Sunforger® Marine Finish Boat Shrunken – Flame Retardant

Where the ultimate is needed in water repellency and mildew resistance, use Marine Finish Boat Shrunken. Expect limited exposure shrinkage of approximately 3%, under normal use. Marine Finish contains a special added compound that gives greater water repellency and mildew resistance.

FABRIC	Cotton Army Duck				
FINISH	Water Repellent Finish				
FR STANDARDS MET	CPAI-84				

ITEM #	STYLE #	COLOR	PUT UP	WEIGHT	WIDTH
714123	938	Colorless	50 yd.	10.38 oz.	36 in.
714125	998	Colorless	50 yd.	12.98 oz.	36 in.

Sunforger® is a registered trademark of M.F. & H Textiles.

Triton®

100% polyester woven fabric with a vinyl-coated top side. Triton Marine Cover Fabric is water repellent and resistant to mildew, UV, petroleum products and a wide range of acid and alkaline liquids. The color won't rub off, and the flexible and durable surface cleans easily with vinyl cleaners. Ideal for personal watercraft covers.

FABRIC	100% Polyester				
FINISH	Vinyl Resin Coated Topside				
WARRANTY	3-Year				

ITEM #	STYLE #	COLOR	PUT UP	WEIGHT	WIDTH
775842	5842	Silver	100 yd.	6 oz.	60 in.

Triton® is a registered trademark of Glen Raven, Inc.

Dacron® Sailcloth and Cover Cloth

Trivantage® offers a premium 3.8 oz. Dacron sailcloth for marine applications. 3.8 oz. Dacron has a stabilized finish and is a proven basic sailcloth.

Trivantage stocks a range of Dacron cover cloth fabrics in a variety of weights. These are ideal for a variety of marine cover applications, and are white in color.

Sailcloth fabrics are specially made for use in sails. Although this fabric is used in the manufacture of other products, it is not engineered or tested for these uses. In this connection we remind you that under the terms and conditions pursuant to which our sailcloth has been and is sold, the manufacturer disclaims all warranties of its sailcloth for fitness for a particular purpose.

Not for use in aeronautical applications.

ITEM #	DESCRIPTION	COLOR	WEIGHT	WIDTH
724104	Dacron	Natural	3.8 oz.	36 in.
724089	Fleetboat Cloth	White	4 oz.	54 in.
724078	Heavy Cloth	Natural	8.9 oz.	54 in.
723999	Heavy Cloth	White	8.5 oz.	54 in.
723998	Medium Cloth	White	6.5 oz.	54 in.
724077	Medium Cloth	White	7 oz.	54 in.

Dacron® is a registered trademark of INVISTA™. Trivantage® is a registered trademark of Glen Raven, Inc.



500723



500727



500728

Dacron® Tape

Available in various widths for use in sails. Used for reinforcement in canvas applications.

ITEM #	COLOR	PUT UP	WEIGHT	WIDTH
500723	Black	100 yd.	3.9 oz.	2 in.
500492	White	100 yd.	6 oz.	1.5 in.
500493	White	60-75 yd.	6 oz.	2 in.
500726	White	100 yd.	6 oz.	2 in.
500495	White	100 yd.	6 oz.	3 in.
500727	White	100 yd.	6 oz.	3 in.
500496	White	100 yd.	6 oz.	4 in.
500728	White	100 yd.	6 oz.	4 in.

Dacron® is a registered trademark of INVISTA™.

Clear Double-Polished Vinyl Rolls

Clear Vinyl will contract and expand with changing temperatures. Allow 1-2% for shrinkage when cutting clear vinyl.

Sold in full rolls only.

ITEM #	DESCRIPTION	COLOR	PUT UP	THICKNESS	WIDTH
972012		Clear	100 yd.	0.012	54 in.
972017		Clear	36 yd.	0.016	54 in.
972016		Clear	72 yd.	0.016	54 in.
972019		Clear	30 yd.	0.020	54 in.
972002		Clear	30 yd.	0.020	54 in.
972113		Clear	5 yd.	0.020	54 in.
972003		Clear	60 yd.	0.020	54 in.
972020		Clear	61 yd.	0.020	54 in.
972036		Clear	20 yd.	0.030	54 in.
971942		Clear	20 yd.	0.030	54 in.
972035		Clear	40 yd.	0.030	54 in.
971941		Clear	40 yd.	0.030	54 in.
972004		Clear	15 yd.	0.040	54 in.
972005		Clear	30 yd.	0.040	54 in.
972021		Light Gray Tint	30 yd.	0.020	54 in.
972102		Smoke	20 yd.	0.030	54 in.
972024	Cold Crack UVI	Clear	60 yd.	0.020	54 in.
972029	Interleaf	Clear	30 yd.	0.020	54 in.
972046	Interleaf	Clear	20 yd.	0.030	54 in.

Clear Double-Polished Vinyl Rolls – Flame Retardant

Clear Vinyl will contract and expand with changing temperatures. Allow 1-2% for shrinkage when cutting clear vinyl.

Sold in full rolls only.

FR STANDARDS MET	California State Fire Marshal Title 19; CPAI-84.
-------------------------	--

ITEM #	DESCRIPTION	PUT UP	THICKNESS	WIDTH
972022		100 yd.	0.012	54 in.
972010		102 yd.	0.012	96 in.
972023		50 yd.	0.012	54 in.
972026		72 yd.	0.016	54 in.
972028		30 yd.	0.020	54 in.
972027		61 yd.	0.020	54 in.
972104		20 yd.	0.030	54 in.
972072		40 yd.	0.030	50 in.
972041	Interleaf	61 yd.	0.020	54 in.

Regalite® Uncoated Press Polished Sheets

Die-cut sheets. Sold in full drums only.

ITEM #	COLOR	PUT UP	SIZE	THICKNESS
972165	Clear	2/drum	54 in. x 110 in.	0.020
972347	Clear	5/drum	54 in. x 110 in.	0.020
972168	Clear	2/drum	54 in. x 110 in.	0.030
972169	Clear	3/drum	54 in. x 110 in.	0.030
972153	Clear	5/drum	54 in. x 110 in.	0.030
972170	Clear	2/drum	54 in. x 110 in.	0.040
972171	Clear	3/drum	54 in. x 110 in.	0.040
972162	Clear	5/drum	54 in. x 110 in.	0.040
972350	Clear	3/drum	54 in. x 110 in.	0.080
972177	Green	3/drum	54 in. x 110 in.	0.040
972173	Smoke	2/drum	54 in. x 110 in.	0.030
972174	Smoke	3/drum	54 in. x 110 in.	0.030
972342	Smoke	5/drum	54 in. x 110 in.	0.030
972175	Smoke	2/drum	54 in. x 110 in.	0.040
972176	Smoke	3/drum	54 in. x 110 in.	0.040
972340	Smoke	5/drum	54 in. x 110 in.	0.040

Regalite® is a registered trademark of O'Sullivan Films.

Regalite® Fenestra Uncoated Press Polished Sheets

With high flame standards and a very minimal shrinkage factor (1%), Fenestra is the clear choice for outdoor enclosure projects such as restaurant windows and patios, sun rooms and greenhouses. Sold in full drums only.

FR STANDARDS MET	0.020 Gauge: FMVSS 302; California 117E; California Title 19 Section 1237 (small scale), 0.030 Gauge: FMVSS 302; California 117E
-------------------------	--

ITEM #	COLOR	PUT UP	SIZE	THICKNESS
972360	Clear	5/drum	54 in. x 110 in.	0.020
972361	Clear	5/drum	54 in. x 110 in.	0.030

Regalite® is a registered trademark of O'Sullivan Films.

Regalite® / O'Sea® Firma Press Polished Sheets

Specifically formulated for those who desire a stiffer hand, FIRMA sheets are harder and less flexible than standard Regalite and O'Sea. Sold in full drums only.

ITEM #	DESCRIPTION	COLOR	PUT UP	SIZE	THICKNESS
972363	O'Sea Coated	Clear	5/drum	54 in. x 110 in.	0.040
972362	Regalite Uncoated	Clear	5/drum	54 in. x 110 in.	0.040

Regalite® is a registered trademark of O'Sullivan Films. O'Sea™ is a trademark of O'Sullivan Films.

Clear Vinyl Extruded

A clear, economical vinyl that is a superb source for building marine enclosures rather than many typical vinyl sheets offered on the market. Great for clear vinyl window replacements as it adapts nicely to the existing vinyl. Because this specialty clear vinyl is extruded rather than laminated, the clarity is superior to other clear vinyl roll goods.

ITEM #	DESCRIPTION	PUT UP	THICKNESS	WIDTH
972301	Firm Hand	14 yd.	0.040	54 in.
972302	Soft Hand	20 yd.	0.030	54 in.

O'Sea™ Coated Press Polished Sheets

O'Sea press polished sheets are ideally suited for applications where exceptional optical clarity and durability are important. These include marine windows, and other enclosures. O'Sea advantages include: Scratch resistance, UV durability, optical clarity, superior stain and chemical resistance and made in the USA.

FABRIC	PVC Clear Pressed Polished Vinyl
FINISH	Scratch, Stain & Chemical Resistance, UV Durability

ITEM #	COLOR	PUT UP	SIZE	THICKNESS
972178	Clear	2/drum	54 in. x 110 in.	0.030
972179	Clear	3/drum	54 in. x 110 in.	0.030
972180	Clear	5/drum	54 in. x 110 in.	0.030
972164	Clear	3/drum	54 in. x 110 in.	0.040
972163	Clear	5/drum	54 in. x 110 in.	0.040
972186	Clear	3/drum	54 in. x 110 in.	0.060
972185	Green	3/drum	54 in. x 110 in.	0.040
972182	Smoke	2/drum	54 in. x 110 in.	0.040
972183	Smoke	3/drum	54 in. x 110 in.	0.040

O'Sea™ is a trademark of O'Sullivan Films

Crystal Clear 20/20

These uncoated press-polished vinyl sheets offer exceptional clarity and flexibility. With excellent UV stability, Crystal Clear resists clouding, yellowing and cracking to provide phenomenal visual light transmission. In a choice of 30 and 40 gauge clear or smoke untrimmed sheets. Made in the USA.

ITEM #	COLOR	PUT UP	SIZE	THICKNESS
972219	Clear	2/drum	54in. x 110in. (+/- 1in.)	0.030
972218	Clear	3/drum	54in. x 110in. (+/- 1in.)	0.030
972217	Clear	5/drum	54in. x 110in. (+/- 1in.)	0.030
972212	Clear	2/drum	54in. x 110in. (+/- 1in.)	0.040
972211	Clear	3/drum	54in. x 110in. (+/- 1in.)	0.040
972210	Clear	5/drum	54in. x 110in. (+/- 1in.)	0.040
972256	Dark Smoke	2/drum	54in. x 110in. (+/- 1in.)	0.040
972255	Dark Smoke	3/drum	54in. x 110in. (+/- 1in.)	0.040
972254	Dark Smoke	5/drum	54in. x 110in. (+/- 1in.)	0.040
972216	Light Smoke	2/drum	54in. x 110in. (+/- 1in.)	0.040
972215	Light Smoke	3/drum	54in. x 110in. (+/- 1in.)	0.040
972214	Light Smoke	5/drum	54in. x 110in. (+/- 1in.)	0.040



Strataglass™ Vinyl Sheets

A remarkably clear and scratch-resistant vinyl sheet, Strataglass performs well in boat curtain, automotive window and awning applications, where perfection of clarity and lack of distortion are demanded. This premium, flexible vinyl sheet resists scratching from handling, etching from industrial fallout and damaging effects from the sun's rays. Made in the USA.

FABRIC	Pressed-Polished Vinyl
FINISH	Scratch Resistant, UV Blocking Urethane

ITEM #	COLOR	PUT UP	SIZE	THICKNESS
972209	Clear	2/drum	54 in. x 110 in.	0.030
972208	Clear	3/drum	54 in. x 110 in.	0.030
972207	Clear	5/drum	54 in. x 110 in.	0.030
972346	Clear	1/drum	54 in. x 110 in.	0.040
972202	Clear	2/drum	54 in. x 110 in.	0.040
972201	Clear	3/drum	54 in. x 110 in.	0.040
972200	Clear	5/drum	54 in. x 110 in.	0.040
972203	Clear	2/drum	54 in. x 110 in.	0.060
971902	Clear	3/drum	54 in. x 110 in.	0.060
972247	Dark Smoke	2/drum	54 in. x 110 in.	0.040
972246	Dark Smoke	3/drum	54 in. x 110 in.	0.040
972245	Dark Smoke	5/drum	54 in. x 110 in.	0.040
972206	Light Smoke	2/drum	54 in. x 110 in.	0.040
972205	Light Smoke	3/drum	54 in. x 110 in.	0.040
972204	Light Smoke	5/drum	54 in. x 110 in.	0.040

Strataglass, Inc., manufacturers of Strataglass™ and Crystal Clear 20/20, endorse IMAR™ Strataglass Protective Cleaner and IMAR Strataglass Protective Polish for maximum benefit recommend its regular use on Strataglass and Crystal Clear 20/20.

Strataglass™ is a trademark of Strataglass, LLC.

Makrolon® AR2

Makrolon AR2 abrasion resistant polycarbonate sheet offers superior abrasion resistance and glasslike surface hardness, along with the impact strength of polycarbonate. It features a unique clear hard coat finish that resists all types of abuse, from physical attack to chemicals and spray paint. Additionally, Makrolon AR2 offers resistance from yellowing and hazing for longer service life in high profile applications.

ITEM #	COLOR	PUT UP	SIZE	THICKNESS
971800	Clear	1/drum	48 in. x 96 in.	0.060
971801	Clear	3/drum	48 in. x 96 in.	0.060
971802	Clear	5/drum	48 in. x 96 in.	0.060

Makrolon® is a registered trademark of PSP Limited.



Sea Clear Polycarbonate

Clear, thin-gauge polycarbonate for side and aft windows. Gives clear visibility and good light transmission.

Available only by drop shipment.

Recommended Handling of Sea Clear

- A masking film is used on both sides of the Sea Clear sheet or roll to prevent scratching during shipment and fabrication.
- For the best protection against abrasion damage to Sea Clear rolls, always store in and dispense from the specially designed box.
- No special tools or equipment are necessary to work with Sea Clear. Just cut and sew with your existing equipment.
- Don't forget to peel mask off when job is completed.
- The creative use of Sea Clear provides a clearer, longer lasting solution for marine or other window applications that do not require roll-up (Sea Clear is not appropriate for traditional roll-up applications).

ITEM #	COLOR	PUT UP	SIZE	THICKNESS
971830	Clear	1/drum	48 in. x 96 in.	0.030
971730	Clear	10 yd.	50 in. x 10 yd.	0.030
971840	Clear	1/drum	48 in. x 96 in.	0.040

Vinyl Clear Strip

Ideal for dock door and overhead door applications. Provides minimal protection for interior/exterior openings from 9 feet to 14 feet high. Operating temperature from -40°F to +140°F.

FR STANDARDS MET	California State Fire Marshal Title 19		
ITEM #	PUT UP	THICKNESS	WIDTH
972081	100 ft.	0.120	12 in.

Nassimi Breeze Seaquest Vinyl Upholstery

Seaquest is a reliable fabric for marine, outdoor, and general upholstery. This fabric is part of the Trivantage® Breeze Collection and offers an embossed PVC outer surface. This line is also available in Roll 'N Pleat.

FABRIC	Poly Rayon
FINISH	Embossed PVC
FR STANDARDS MET	California Technical Bulletin 117; MVSS 302
WARRANTY	3-Year

ITEM #	STYLE #	COLOR	PUT UP	WEIGHT	WIDTH
732701	PSQ-001	Seaquest American Beauty	40 yd.	32 oz./ly.	54 in.
732702	PSQ-002	Seaquest Anchor	40 yd.	32 oz./ly.	54 in.
732703	PSQ-003	Seaquest Buff	40 yd.	32 oz./ly.	54 in.
732704	PSQ-004	Seaquest Chalk	40 yd.	32 oz./ly.	54 in.
732705	PSQ-005	Seaquest Cove	40 yd.	32 oz./ly.	54 in.
732706	PSQ-006	Seaquest Dune	40 yd.	32 oz./ly.	54 in.
732707	PSQ-007	Seaquest Ebony	40 yd.	32 oz./ly.	54 in.
732708	PSQ-008	Seaquest Emerald	40 yd.	32 oz./ly.	54 in.
732709	PSQ-009	Seaquest Forest	40 yd.	32 oz./ly.	54 in.
732710	PSQ-010	Seaquest Hampton	40 yd.	32 oz./ly.	54 in.
732711	PSQ-011	Seaquest Havasu	40 yd.	32 oz./ly.	54 in.
732712	PSQ-012	Seaquest Lemon Peel	40 yd.	32 oz./ly.	54 in.
732713	PSQ-013	Seaquest Lighthouse Red	40 yd.	32 oz./ly.	54 in.
732714	PSQ-014	Seaquest Lotion	40 yd.	32 oz./ly.	54 in.
732715	PSQ-015	Seaquest Marble	40 yd.	32 oz./ly.	54 in.
732716	PSQ-016	Seaquest Midnight	40 yd.	32 oz./ly.	54 in.
732717	PSQ-017	Seaquest Mist	40 yd.	32 oz./ly.	54 in.
732718	PSQ-018	Seaquest Navel	40 yd.	32 oz./ly.	54 in.
732719	PSQ-019	Seaquest Navy	40 yd.	32 oz./ly.	54 in.
732720	PSQ-020	Seaquest Oyster	40 yd.	32 oz./ly.	54 in.
732721	PSQ-021	Seaquest Pearl Oyster	40 yd.	32 oz./ly.	54 in.
732722	PSQ-022	Seaquest Pelican	40 yd.	32 oz./ly.	54 in.
732723	PSQ-023	Seaquest Royal	40 yd.	32 oz./ly.	54 in.
732724	PSQ-024	Seaquest Ruby	40 yd.	32 oz./ly.	54 in.
732725	XSQ (PSQ)-025	Seaquest Sea White	40 yd.	32 oz./ly.	54 in.
732726	PSQ-026	Seaquest Smoke	40 yd.	32 oz./ly.	54 in.
732727	PSQ-027	Seaquest Teal	40 yd.	32 oz./ly.	54 in.
732729	PSQ-029	Seaquest Too White	40 yd.	32 oz./ly.	54 in.
732730	PSQ-030	Seaquest White Ice	40 yd.	32 oz./ly.	54 in.

Trivantage® is a registered trademark of Glen Raven, Inc.

Nassimi Breeze Seaquest Roll 'N Pleat Vinyl Upholstery

Seaquest is a reliable fabric for marine, outdoor, and general upholstery. This fabric is part of the Trivantage® Breeze Collection and offers an embossed PVC outer surface.

FABRIC	Poly Rayon
FINISH	Embossed PVC
FR STANDARDS MET	California Technical Bulletin 117; MVSS 302
WARRANTY	3-Year

ITEM #	STYLE #	COLOR	PUT UP	WIDTH
732901	PSP-001	Seaquest American Beauty	15 yd.	54 in.
732902	PSP-002	Seaquest Anchor	15 yd.	54 in.
732903	PSP-003	Seaquest Buff	15 yd.	54 in.
732904	PSP-004	Seaquest Chalk	15 yd.	54 in.
732905	PSP-005	Seaquest Cove	15 yd.	54 in.
732906	PSP-006	Seaquest Dune	15 yd.	54 in.
732907	PSP-007	Seaquest Ebony	15 yd.	54 in.
732908	PSP-008	Seaquest Emerald	15 yd.	54 in.
732909	PSP-009	Seaquest Forest	15 yd.	54 in.
732910	PSP-010	Seaquest Hampton	15 yd.	54 in.
732911	PSP-011	Seaquest Havasu	15 yd.	54 in.
732912	PSP-012	Seaquest Lemon Peel	15 yd.	54 in.
732913	PSP-013	Seaquest Lighthouse Red	15 yd.	54 in.
732914	PSP-014	Seaquest Lotion	15 yd.	54 in.
732915	PSP-015	Seaquest Marble	15 yd.	54 in.
732916	PSP-016	Seaquest Midnight	15 yd.	54 in.
732917	PSP-017	Seaquest Mist	15 yd.	54 in.
732918	PSP-018	Seaquest Navel	15 yd.	54 in.
732919	PSP-019	Seaquest Navy	15 yd.	54 in.
732920	PSP-020	Seaquest Oyster	15 yd.	54 in.
732921	PSP-021	Seaquest Pearl Oyster	15 yd.	54 in.
732922	PSP-022	Seaquest Pelican	15 yd.	54 in.
732923	PSP-023	Seaquest Royal	15 yd.	54 in.
732924	PSP-024	Seaquest Ruby	15 yd.	54 in.
732925	XSP (PSP)-025	Seaquest Sea White	15 yd.	54 in.
732926	PSP-026	Seaquest Smoke	15 yd.	54 in.
732927	PSP-027	Seaquest Teal	15 yd.	54 in.
732929	PSP-029	Seaquest Too White	15 yd.	54 in.
732930	PSP-030	Seaquest White Ice	15 yd.	54 in.

Trivantage® is a registered trademark of Glen Raven, Inc.

Nassimi Breeze Seaquest Hydrem Gimp

Hydrem gimp is used to hide staples in upholstery applications. Colors correspond with the Nassimi Breeze Seaquest Vinyl Upholstery collection.

ITEM #	COLOR	PUT UP	WIDTH
515831	American Beauty	25 yd.	5/8 in.
515832	Anchor	25 yd.	5/8 in.
515833	Buff	25 yd.	5/8 in.
515834	Chalk	25 yd.	5/8 in.
515835	Cove	25 yd.	5/8 in.
515836	Dune	25 yd.	5/8 in.
515837	Ebony	25 yd.	5/8 in.
515838	Emerald	25 yd.	5/8 in.
515839	Forest	25 yd.	5/8 in.
515840	Hampton	25 yd.	5/8 in.
515841	Havasu	25 yd.	5/8 in.
515842	Lemon Peel	25 yd.	5/8 in.
515843	Lighthouse Red	25 yd.	5/8 in.
515844	Lotion	25 yd.	5/8 in.
515845	Marble	25 yd.	5/8 in.
515846	Midnight	25 yd.	5/8 in.
515847	Mist	25 yd.	5/8 in.
515848	Navel	25 yd.	5/8 in.
515849	Navy	25 yd.	5/8 in.
515850	Oyster	25 yd.	5/8 in.
515851	Pearl Oyster	25 yd.	5/8 in.
515852	Pelican	25 yd.	5/8 in.
515853	Royal	25 yd.	5/8 in.
515854	Ruby	25 yd.	5/8 in.
515855	Sea White	25 yd.	5/8 in.
515856	Smoke	25 yd.	5/8 in.
515857	Teal	25 yd.	5/8 in.
515859	Too White	25 yd.	5/8 in.
515860	White Ice	25 yd.	5/8 in.

Nassimi Breeze Seaquest Welt

Welt is used to visually enhance a seam on seating. Colors correspond with the Nassimi Breeze Seaquest Vinyl Upholstery collection.

ITEM #	COLOR	PUT UP	WIDTH
515861	American Beauty	50 yd.	5/8 in.
515862	Anchor	50 yd.	5/8 in.
515863	Buff	50 yd.	5/8 in.
515864	Chalk	50 yd.	5/8 in.
515865	Cove	50 yd.	5/8 in.
515866	Dune	50 yd.	5/8 in.
515867	Ebony	50 yd.	5/8 in.
515868	Emerald	50 yd.	5/8 in.
515869	Forest	50 yd.	5/8 in.
515870	Hampton	50 yd.	5/8 in.
515871	Havasu	50 yd.	5/8 in.
515872	Lemon Peel	50 yd.	5/8 in.
515873	Lighthouse Red	50 yd.	5/8 in.
515874	Lotion	50 yd.	5/8 in.
515875	Marble	50 yd.	5/8 in.
515876	Midnight	50 yd.	5/8 in.
515877	Mist	50 yd.	5/8 in.
515878	Navel	50 yd.	5/8 in.
515879	Navy	50 yd.	5/8 in.
515880	Oyster	50 yd.	5/8 in.
515881	Pearl Oyster	50 yd.	5/8 in.
515882	Pelican	50 yd.	5/8 in.
515883	Royal	50 yd.	5/8 in.
515884	Ruby	50 yd.	5/8 in.
515885	Sea White	50 yd.	5/8 in.
515886	Smoke	50 yd.	5/8 in.
515887	Teal	50 yd.	5/8 in.
515889	Too White	50 yd.	5/8 in.
515890	White Ice	50 yd.	5/8 in.

Nassimi Breeze Beachcomber Vinyl Upholstery

Beachcomber is a contemporary honeycomb pattern. The line is part of the Trivantage® Breeze Collection, and contains 14 unique color options. It is a combination of excellent abrasion, mildew and UV resistance. Perfect for any marine or outdoor needs.

FABRIC	Polyester Knit
FINISH	Embossed PVC
FR STANDARDS MET	California Technical Bulletin 117; MVSS 302
WARRANTY	3-Year

ITEM #	STYLE #	COLOR	PUT UP	WEIGHT	WIDTH
732751	PBC-001	Beachcomber Adriatic	30 yd.	32 oz./ly.	54 in.
732752	PBC-002	Beachcomber Blue Lagoon	30 yd.	32 oz./ly.	54 in.
732753	PBC-003	Beachcomber Brite White	30 yd.	32 oz./ly.	54 in.
732754	PBC-004	Beachcomber Carbon	30 yd.	32 oz./ly.	54 in.

ITEM #	STYLE #	COLOR	PUT UP	WEIGHT	WIDTH
732755	PBC-005	Beachcomber Cosmos	30 yd.	32 oz./ly.	54 in.
732756	PBC-006	Beachcomber Frost Grey	30 yd.	32 oz./ly.	54 in.
732757	PBC-007	Beachcomber Indian Summer	30 yd.	32 oz./ly.	54 in.
732758	PBC-008	Beachcomber Sandstone	30 yd.	32 oz./ly.	54 in.
732759	PBC-009	Beachcomber Seagrass	30 yd.	32 oz./ly.	54 in.
732760	PBC-010	Beachcomber Shell	30 yd.	32 oz./ly.	54 in.
732761	PBC-011	Beachcomber Sunset	30 yd.	32 oz./ly.	54 in.
732762	PBC-012	Beachcomber Surfboard Yellow	30 yd.	32 oz./ly.	54 in.
732763	PBC-013	Beachcomber Tangerine	30 yd.	32 oz./ly.	54 in.
732764	PBC-014	Beachcomber Warm White	30 yd.	32 oz./ly.	54 in.

Trivantage® is a registered trademark of Glen Raven, Inc.

Nassimi Breeze Phoenix Vinyl Upholstery

The Phoenix line offers a smooth emu/baby ostrich emboss and features Resilience-SR protection. Part of the Trivantage® Breeze Collection, this line contains 13 unique colors. This fabric is ideal for marine, outdoor and hospitality upholstery needs, as well as other upholstery applications. Phoenix is antimicrobial, stain resistant and UV resistant and has excellent abrasion resistance.

FABRIC	Polyester
FINISH	Embossed PVC
FR STANDARDS MET	California Technical Bulletin 117; MVSS 302
WARRANTY	3-Year

ITEM #	STYLE #	COLOR	PUT UP	WEIGHT	WIDTH
732791	TPH-001	Phoenix Biscotti	30 yd.	28 oz./ly.	54 in.
732792	TPH-002	Phoenix Black Forest	30 yd.	28 oz./ly.	54 in.
732793	TPH-003	Phoenix Caviar	30 yd.	28 oz./ly.	54 in.
732794	TPH-004	Phoenix Chocolate Chip	30 yd.	28 oz./ly.	54 in.
732795	TPH-005	Phoenix Chutney	30 yd.	28 oz./ly.	54 in.
732796	TPH-006	Phoenix Drizzle	30 yd.	28 oz./ly.	54 in.
732797	TPH-007	Phoenix Fog	30 yd.	28 oz./ly.	54 in.
732798	TPH-008	Phoenix Lemonade	30 yd.	28 oz./ly.	54 in.
732799	TPH-009	Phoenix Ochre	30 yd.	28 oz./ly.	54 in.
732800	TPH-010	Phoenix Outback	30 yd.	28 oz./ly.	54 in.
732801	TPH-011	Phoenix Ruby	30 yd.	28 oz./ly.	54 in.
732802	TPH-012	Phoenix Snowflake	30 yd.	28 oz./ly.	54 in.
732803	TPH-013	Phoenix Willow	30 yd.	28 oz./ly.	54 in.

Trivantage® is a registered trademark of Glen Raven, Inc.

Nassimi Breeze Vibe Vinyl Upholstery

Vibe, part of the Trivantage® Breeze Collection, offers a distinctive look of fabric while offering the durability and ease of care of faux leather. This material offers Resilience-SR protection and is mildew, UV, and stain resistant. Vibe is suitable for automotive, marine, outdoor, and hospitality applications.

FABRIC	Polyester
FINISH	Embossed PVC
FR STANDARDS MET	California Technical Bulletin 117; MVSS 302
WARRANTY	3-Year

ITEM #	STYLE #	COLOR	PUT UP	WEIGHT	WIDTH
732771	TVI-001	Vibe Alchemy	30 yd.	28 oz./ly.	54 in.
732772	TVI-002	Vibe Ballpoint	30 yd.	28 oz./ly.	54 in.
732773	TVI-003	Vibe Black Currant	30 yd.	28 oz./ly.	54 in.
732774	TVI-004	Vibe Bombay Blue	30 yd.	28 oz./ly.	54 in.
732775	TVI-005	Vibe Caribbean	30 yd.	28 oz./ly.	54 in.
732776	TVI-006	Vibe Cityscape	30 yd.	28 oz./ly.	54 in.
732777	TVI-007	Vibe Clementine	30 yd.	28 oz./ly.	54 in.
732778	TVI-008	Vibe Clover	30 yd.	28 oz./ly.	54 in.
732779	TVI-009	Vibe Cocoa	30 yd.	28 oz./ly.	54 in.
732780	TVI-010	Vibe Cornsilk	30 yd.	28 oz./ly.	54 in.
732781	TVI-011	Vibe Flax	30 yd.	28 oz./ly.	54 in.
732782	TVI-012	Vibe Grasshopper	30 yd.	28 oz./ly.	54 in.
732783	TVI-013	Vibe Indian Summer	30 yd.	28 oz./ly.	54 in.
732784	TVI-014	Vibe Irish Linen	30 yd.	28 oz./ly.	54 in.
732785	TVI-015	Vibe Mushroom	30 yd.	28 oz./ly.	54 in.
732786	TVI-016	Vibe Punch	30 yd.	28 oz./ly.	54 in.
732787	TVI-017	Vibe Sunset	30 yd.	28 oz./ly.	54 in.

Trivantage® is a registered trademark of Glen Raven, Inc.



Ultrafabrics® Brisa® Indoor/Outdoor Collection

The Brisa Collection is a group of luxurious simulated leather fabrics that are formulated to resist fading and spotting over extended periods of direct sunlight. Suited for both indoor and outdoor applications, this soft and beautiful fabric is durable and scratch resistant.

Environmentally friendly, Brisa does not contain plasticizers, heavy metals, or stabilizers, and is free of VOCs (CA 01350 compliant), POPs, HFRs (Halogenated Flame Retardants) and formaldehyde. Since most spills and stains clean easily with mild detergent and water, there's no worry about toxic chemicals and harsh cleaners polluting the air. The process is also friendly to the environment – 99% of all solvents used in production are captured and recycled.

FABRIC	Breathable 100% Polyurethane Surface with 65% Polyester/35% Rayon Backing
FR STANDARDS MET	FMVSS 302; 95/28 Annex IV; California Technical Bulletin 117, Section E Class 1; UFAC Class 1; NFPA 260 Class 1

ITEM #	STYLE #	COLOR	PUT UP	WEIGHT	WIDTH
734902	3823	Aztec	50 yd.	9.6 oz.	54 in.
734909	5749	Black Onyx	50 yd.	9.6 oz.	54 in.
734912	3134	Buckskin Distressed	50 yd.	9.6 oz.	54 in.
734911	3024	Chamois Distressed	50 yd.	9.6 oz.	54 in.
734914	3970	Chaps Distressed	30 yd.	9.6 oz.	54 in.
734907	3160	Durango	50 yd.	9.6 oz.	54 in.
734919	3733	Greige Distressed	50 yd.	9.6 oz.	54 in.
734900	5852	Jasper	50 yd.	9.6 oz.	54 in.
734913	3972	Lasso Distressed	50 yd.	9.6 oz.	54 in.
734918	3361	Mohave Distressed	50 yd.	9.6 oz.	54 in.
734935	393-5875	Nimbus	50 yd.	9.6 oz.	54 in.
734901	5750	Polar	50 yd.	9.6 oz.	54 in.
734915	3980	Waylan Distressed	50 yd.	9.6 oz.	54 in.

Brisa® is a registered trademark of Ultrafabrics, LLC.

Ultrafabrics® Promessa® Indoor/Outdoor Collection

The Promessa Collection is a group of luxurious simulated leather fabrics that are formulated to resist fading and spotting over extended periods of direct sunlight. Suited for both indoor and outdoor applications, this soft and beautiful fabric is durable and scratch resistant.

Environmentally friendly, Promessa does not contain plasticizers, heavy metals, or stabilizers, and is free of VOCs (CA 01350 compliant), POPs, HFRs (Halogenated Flame Retardants) and formaldehyde. Since most spills and stains clean easily with mild detergent and water, there's no worry about toxic chemicals and harsh cleaners polluting the air. The process is also friendly to the environment – 99% of all solvents used in production are captured and recycled.

FABRIC	100% Polyurethane Surface with 65% Polyester/35% Rayon Backing
FR STANDARDS MET	FMVSS 302; California Technical Bulletin 117, Section E Class 1; UFAC Class 1; NFPA 260 Class 1

ITEM #	STYLE #	COLOR	PUT UP	WEIGHT	WIDTH
734923	5805	Ermine	50 yd.	12 oz.	54 in.
734925	3619	Linen	50 yd.	12 oz.	54 in.
734924	2693	Marine Midnight	50 yd.	12 oz.	54 in.
734926	5765	New Moon	50 yd.	12 oz.	54 in.

Brisa® is a registered trademark of Ultrafabrics, LLC.

Nautolex® Capitano™ Marine Vinyl Upholstery

Capitano is formulated with quality pigments and additives to resist fading, bacteria and mildew growth. The colors selected for Capitano coordinate with all of today's interior carpeting, exterior gel systems, graphics and interior trim components. The sturdy, expanded construction utilizes a heavy-duty, 100% polyester filament backing that has superior strength and great stretch and set qualities. It is perfect for today's seat designs, which involve tailoring around tight corners. It has a durable skin layer, which is resistant to picking and abrasion and cleans easily.

FABRIC	100% Polyester
FINISH	Vinyl
FR STANDARDS MET	California Technical Bulletin 117, Section E
WARRANTY	5-Year

ITEM #	STYLE #	COLOR	PUT UP	WEIGHT	WIDTH
734322	519970 (44919200)	Beach White	40 yd.	30 oz./ly.	54 in.
734327	513846 (45869400)	Blue Chip	40 yd.	30 oz./ly.	54 in.
734357	517582 (49206500)	Cancun Blue	40 yd.	30 oz./ly.	54 in.
734362	518236 (48562200)	Cityscape	40 yd.	30 oz./ly.	54 in.
734311	513658 (44800000)	Cloud White	40 yd.	30 oz./ly.	54 in.
734312	514006 (44800100)	Conch Shell	40 yd.	30 oz./ly.	54 in.
734344	517583 (49206600)	Cornerstone	40 yd.	30 oz./ly.	54 in.
734318	513832 (44800700)	Cyberspace	40 yd.	30 oz./ly.	54 in.
734347	517584 (49206700)	Daiquiri	40 yd.	30 oz./ly.	54 in.
734323	513952 (45869000)	Daredevil	40 yd.	30 oz./ly.	54 in.
734328	513900 (45869500)	Eclipse	40 yd.	30 oz./ly.	54 in.
734325	514009 (45869200)	Galapagos	40 yd.	30 oz./ly.	54 in.
734336	517585 (49206800)	Heron	40 yd.	30 oz./ly.	54 in.
734332	513660 (45869900)	Lemon Drop	40 yd.	30 oz./ly.	54 in.

ITEM #	STYLE #	COLOR	PUT UP	WEIGHT	WIDTH
734363	517910 (49206900)	Mandarin	40 yd.	30 oz./ly.	54 in.
734334	517586 (49207000)	Marooned	40 yd.	30 oz./ly.	54 in.
734337	517587 (49207100)	Nuance	40 yd.	30 oz./ly.	54 in.
734346	517588 (49207200)	Parakeet	40 yd.	30 oz./ly.	54 in.
734345	517589 (49207300)	Party Pink	40 yd.	30 oz./ly.	54 in.
734358	517590 (49207400)	Pennywise	40 yd.	30 oz./ly.	54 in.
734348	517591 (49207500)	Rain	40 yd.	30 oz./ly.	54 in.
734329	513659 (45869600)	Riviera	40 yd.	30 oz./ly.	54 in.
734359	517592 (49207600)	Root Beer	40 yd.	30 oz./ly.	54 in.
734313	513903 (44800200)	Sand Dollar	40 yd.	30 oz./ly.	54 in.
734319	514287 (44800800)	Sand Shell	40 yd.	30 oz./ly.	54 in.
734326	513887 (45869300)	Techno Gray	40 yd.	30 oz./ly.	54 in.
734331	513937 (45869800)	Totally Tan	40 yd.	30 oz./ly.	54 in.
734349	517593 (49207700)	Wild Orchid	40 yd.	30 oz./ly.	54 in.

Nautolex® is a registered trademark of OMNOVA Solutions, Inc. Capitano™ is a trademark of OMNOVA Solutions, Inc.

Nautolex® Capitano™ Channeling

Nautolex Capitano Channeling is a 1-1/2 inch wide handsomely styled, quilted fabric. It exhibits outstanding resistance to stains, abrasion, scuffing and burnishing, and it cleans up easily. It is formulated with the highest quality pigments and additives to resist fading, bacteria and mildew growth.

FABRIC	Coated Polyester Net Backing
FINISH	Vinyl
WARRANTY	None

ITEM #	STYLE #	COLOR	PUT UP	WEIGHT	WIDTH
734283	448000	Cloud White	20 yd.	37.3 oz.	54 in.
734280	448001	Conch Shell	20 yd.	37.3 oz.	54 in.

Nautolex® is a registered trademark of OMNOVA Solutions, Inc. Capitano™ is a trademark of OMNOVA Solutions, Inc.



Nautolex® Capitano™ Hydem Gimp

ITEM #	STYLE #	COLOR	PUT UP	WIDTH
515825	449192	Beach White	25 yd.	3/4 in.
515822	448000	Cloud White	25 yd.	3/4 in.
515820	448001	Conch Shell	25 yd.	3/4 in.
515828	448007	Cyberspace	25 yd.	3/4 in.
515830	448008	Sandshell	25 yd.	3/4 in.

Nautolex® is a registered trademark of OMNOVA Solutions, Inc. Capitano™ is a trademark of OMNOVA Solutions, Inc.



Nautolex® SofDura

SofDura is a heavy weight marine grade upholstery product with a softer than average hand. Superior durability for heavy-duty areas such as seating and backing. Water repellent and excellent resistance to abrasion, scuffing, mildew and fading caused by UV exposure. Protected with the unique PreFixx® protective finish that resists staining and provides exceptional ease of cleaning. 100% polyester filament backing.

FABRIC	100% Polyester Knit
FINISH	PreFixx®
FR STANDARDS MET	California Technical Bulletin 117, Section E
WARRANTY	5-Year

ITEM #	STYLE #	COLOR	PUT UP	WEIGHT	WIDTH
734225	520201 (458705)	Aluminum	40 yd.	36 oz./ly.	54 in.
734214	514472 (483463)	Canvas	40 yd.	36 oz./ly.	54 in.
734249	515324 (490669)	Dolphin	40 yd.	36 oz./ly.	54 in.
734213	472137	Iron	40 yd.	36 oz./ly.	54 in.
734230	514444 (458710)	Mystic White	40 yd.	36 oz./ly.	54 in.
734231	520200 (458711)	Shell	40 yd.	36 oz./ly.	54 in.
734235	458715	Stone	40 yd.	36 oz./ly.	54 in.

Nautolex® and PreFixx® are registered trademarks of OMNOVA Solutions Inc.

Nautolex® SofDura Channeling

Trim and cushion insert design.

FABRIC	100% Polyester Knit
FINISH	PreFixx®
WARRANTY	None

ITEM #	STYLE #	COLOR	PUT UP	WEIGHT	WIDTH
734256	734256	Mystic White	20 yd.	37.3 oz.	54 in.

Nautolex® and PreFixx® are registered trademarks of OMNOVA Solutions Inc.

Nautolex® Voyager®

The finest marine grade vinyl, Nautolex Voyager is coated with a PreFixx® protective finish so it can be cleaned easily, over and over, without showing signs of wear. The special finish provides excellent stain, scuff and abrasion resistance. And, it protects against damaging UV rays to assure long-lasting bright colors. Applications include exterior or interior cushions, boat seat covers, pillows and more.

FABRIC	Marine Grade Coated Vinyl
FINISH	PreFixx®
FR STANDARDS MET	California Technical Bulletin 117, Section E
WARRANTY	5-Year

ITEM #	STYLE #	COLOR	PUT UP	WEIGHT	WIDTH
733066	518427	Mystic White	40 yd.	30 oz./ly.	54 in.
733068	513716	Off White	40 yd.	30 oz./ly.	54 in.

Nautolex®, Voyager® and PreFixx® are registered trademarks of OMNOVA Solutions, Inc.

Nautolex® Voyager Channeling

This fabric's special PreFixx® protective finish provides excellent stain, scuff and abrasion resistance, and protects against damaging UV rays to assure long-lasting colors.

FABRIC	Nautolex Voyager with 6.6 oz. polyester backing
FINISH	PreFixx®
WARRANTY	None

ITEM #	STYLE #	COLOR	PUT UP	WEIGHT	WIDTH
734275	NAU771	Mystic White	20 yd.	33 oz.	54 in.
734277	NAU773	Off White	20 yd.	33 oz.	54 in.

Nautolex® and PreFixx® are registered trademarks of OMNOVA Solutions Inc.

Nautolex® Headliner

This headliner fabric is produced from top-quality upholstery fabric with a 1/4 in. polyether urethane foam that is flame laminated to the backside and stabilized to minimize the hardening and drying that is common in other foams. It also has an antimicrobial treatment to prevent the growth of mold and mildew. As a result, this headliner fabric will stand up to the high temperatures and moist conditions of harsh marine environments.

FABRIC	Capitano Marine Vinyl, flame laminated with 1/4 in. polyether urethane foam
FINISH	PreFixx®

ITEM #	COLOR	PUT UP	WEIGHT	WIDTH
733125	Cloud White	40 yd.	33 oz./ly.	54 in.
733126	Conch Shell	40 yd.	33 oz./ly.	54 in.

High quality adhesives should be used with the headliner fabric and care must be taken to avoid pooling of adhesive on the headliner fabric or the surface the fabric is to be secured to.

Nautolex® and PreFixx® are registered trademarks of OMNOVA Solutions Inc.



Canvex®

A translucent, reinforced plastic sheeting manufactured by weaving high-density polyethylene ribbons and coating them with a low-density polyethylene. This special weaving process produces a highly tear-resistant film that allows the ribbons to shift and “bunch up” in response to a tearing force. Canvex is commonly used for applications requiring exceptional tear resistance and minimal weight, including use on construction sites to enclose buildings and cover materials during construction. Other common applications for Canvex include temporary walls, abatement enclosures, equipment covers, silage and cargo covers, carpet and product wrappings, curtains, and insulation membranes. Also used as inexpensive pattern cloth.

Canvex I has the polyethylene coating on one side. Canvex II has the polyethylene coating on both sides. Sold in full rolls only.

FABRIC	High Density Reinforced Polyethylene				
FINISH	Low Density Polyethylene				
ITEM #	DESCRIPTION	COLOR	PUT UP	WEIGHT	WIDTH
971652	Canvex I	Clear	100 yd.	2.31 oz.	81 in.
971651	Canvex II	Clear	100 yd.		72 in.

Canvex® is a registered trademark of Raven Industries.

Nautolex® Underlining

Highly durable fabric used by seat manufacturers to cover boat seat bottoms, hiding springs and screws from sight.

FABRIC	Polyester Mesh				
FINISH	Textured Matte Vinyl				
ITEM #	STYLE #	COLOR	PUT UP	WEIGHT	WIDTH
734305	524147 (42351900)	Almond	100 yd.	8.4 oz./ly.	54 in.
734302	524148 (31694800)	Black	100 yd.	8.4 oz./ly.	54 in.
734303	524146 (38564600)	Light Gray	100 yd.	8.4 oz./ly.	54 in.
734304	522288 (39096400)	White	100 yd.	8.4 oz./ly.	54 in.

Nautolex® is a registered trademark of OMNOVA Solutions, Inc.

Nautolex® Marine Flooring

Nautolex Marine Flooring is non-absorbent, impervious to gasoline, oil and battery acid. UV, mildew and water resistance enable these materials to last many years out in sun, salt water and other harsh weather elements. It has a no-slip texture and is ergonomic.

FABRIC	Vinyl				
FINISH	Acrylic Top Coat				
WARRANTY	3-Year				
ITEM #	STYLE #	COLOR	PUT UP	WEIGHT	WIDTH
734391	522755 (323987)	Shark	25 yd.	24 oz.	74 in.

Nautolex® is a registered trademark of OMNOVA Solutions, Inc.

Pattern Fabric

Lightweight fabric designed for short-term tarps and similar applications. With its strong and flexible composition, Pattern Fabric material works great on any job, anywhere. Its unique non-stretch translucent composition allows you to quickly produce accurate patterns.

FABRIC	Woven Clear HDPE Scrim				
ITEM #	COLOR	PUT UP	WEIGHT	WIDTH	
971655	Clear	50 yd.	3 oz.	144 in.	

Michigan Cloth – Cordura®

Cordura Plus is a textured nylon for a natural spun-like appearance, with excellent resistance to abrasion, rot and mildew. Quick drying, and highly water-repellent.

Suggested Uses: Courier bags, insulated food service carriers, gun cases, stuff bags, camera bags, wallets, duffel bags, soft-sided luggage, purses, handbags, horse blankets, police and air and sea rescue supply bags, surfboard/ski carrying bags, sporting goods and equipment.

FABRIC	1000-Denier Cordura® Nylon				
FINISH	0.75 oz. Urethane Coated, DWR				
ITEM #	COLOR	DENIER	PUT UP	WEIGHT	WIDTH
726137	Black	1000 UR	50 yd.	9.1 oz.	59 in.
726140	Burgundy	1000 UR	50 yd.	9.1 oz.	59 in.
726134	Dark Brown	1000 UR	50 yd.	9.1 oz.	59 in.
726129	Dark Navy	1000 UR	50 yd.	9.1 oz.	59 in.
726147	Electric Blue	1000 UR	50 yd.	9.1 oz.	59 in.
726162	Forest Green	1000 UR	50 yd.	9.1 oz.	59 in.
726142	Gray	1000 UR	50 yd.	9.1 oz.	59 in.
726135	Green	1000 UR	50 yd.	9.1 oz.	59 in.

ITEM #	COLOR	DENIER	PUT UP	WEIGHT	WIDTH
726127	Marigold	1000 UR	50 yd.	9.1 oz.	59 in.
726138	Navy	1000 UR	50 yd.	9.1 oz.	59 in.
726132	Red	1000 UR	50 yd.	9.1 oz.	59 in.
726130	Royal	1000 UR	50 yd.	9.1 oz.	59 in.
726170	WWII Autumn Camo Print	1000 D	50 yd.	10.5 oz.	59 in.
726128	White	1000 UR	50 yd.	9.1 oz.	59 in.

726170 - 1 oz. Urethane Coating

Cordura® is a registered trademark of INVISTA.

California Oxford Cloth

Lightweight, water-repellent nylon oxford ideal for linings, lightweight bags and promotional items.

FABRIC	210-Denier Nylon
FINISH	Urethane Coated, DWR

ITEM #	STYLE #	COLOR	DENIER	PUT UP	WEIGHT	WIDTH
726452	210D	Black	210 D	100 yd.	4 oz.	58 in.
726454	210D	Forest Green	210 D	100 yd.	4 oz.	58 in.
726458	210D	Red	210 D	100 yd.	4 oz.	58 in.
726461	210D	Royal Electric Blue	210 D	100 yd.	4 oz.	58 in.
726450	210D	White	210 D	100 yd.	4 oz.	58 in.

Ohio Pack Cloth

Excellent dye fastness. The 1/2 to 3/4 ounce urethane coating gives superior water repellency, while maintaining a soft hand and lightweight construction. Rot and mildew resistant.

FABRIC	Nylon
FINISH	1/2-3/4 oz. Urethane Coating, DWR

ITEM #	COLOR	DENIER	PUT UP	WEIGHT	WIDTH
724607	Black	400 UR	100 yd.	6.2 oz.	59 in.
724623	Charcoal Gray	400 UR	100 yd.	6.2 oz.	59 in.
724609	Orange	400 UR	100 yd.	6.2 oz.	59 in.
724602	Red	400 UR	100 yd.	6.2 oz.	59 in.
724600	Royal Blue	400 UR	100 yd.	6.2 oz.	59 in.
724617	White	400 UR	100 yd.	6.2 oz.	59 in.

Kentucky Pack Cloth

FABRIC	420-Denier Nylon
FINISH	3/4 oz. Urethane Coated, DWR

ITEM #	COLOR	DENIER	PUT UP	WEIGHT	WIDTH
726202	Black	420 SD	70 yd.	5.2 oz.	58 in.
726210	Burgundy	420 SD	70 yd.	5.2 oz.	58 in.
726215	Charcoal	420 SD	70 yd.	5.2 oz.	58 in.
726228	Chocolate Chip Camo	420 SD	70 yd.	5.2 oz.	58 in.
726208	Coffee Brown	420 SD	70 yd.	5.2 oz.	58 in.
726211	Electric Blue	420 SD	70 yd.	5.2 oz.	58 in.
726224	Fluorescent Orange	420 SD	70 yd.	5.2 oz.	58 in.
726225	Foliage Green	420 SD	70 yd.	5.2 oz.	58 in.
726204	Forest Green	420 SD	70 yd.	5.2 oz.	58 in.
726212	Light Navy	420 SD	70 yd.	5.2 oz.	58 in.
726207	Orange	420 SD	70 yd.	5.2 oz.	58 in.
726223	True Red	420 SD	70 yd.	5.2 oz.	58 in.
726200	White	420 SD	70 yd.	5.2 oz.	58 in.
726229	Woodland Camo	420 SD	70 yd.	5.2 oz.	58 in.
726219	Yellow	420 SD	70 yd.	5.2 oz.	58 in.

Oregon Oxford Cloth

This popular lightweight construction is urethane back-coated, rendering a good degree of water repellency while maintaining a soft hand. Not affected by rot or mildew.

Suggested Uses: Bicycle bags, storage covers, apparel, duffel bags, wallets, backpacks, ski-cases and handbags.

FABRIC	200-Denier Nylon
FINISH	1/2-3/4 oz. Urethane Coating, DWR

ITEM #	COLOR	DENIER	PUT UP	WEIGHT	WIDTH
724322	Black	200 UR	100 yd.	3.5 oz.	59 in.
724337	Forest Green	200 UR	100 yd.	3.5 oz.	59 in.
724323	Navy Blue	200 UR	100 yd.	3.5 oz.	59 in.
724321	Red	200 UR	100 yd.	3.5 oz.	59 in.
724330	White	200 UR	100 yd.	3.5 oz.	59 in.

Nylon Taffeta

A good choice when a lightweight yarn with a firm hand is needed. This 70-Denier nylon taffeta can be used in applications such as purses, bags, cases and storage covers.

FABRIC	70-Denier Nylon Taffeta			
FINISH	PVC Backed			
ITEM #	COLOR	PUT UP	WEIGHT	WIDTH
724792	Black	70 yd.	9.4 oz.	58 in.

Montana Cloth

An economical alternative for the 1000-Denier nylon fabrics, Montana is a water-resistant fabric with excellent resistance to scuffing and pilling. It stands up to demanding use and has a long-lasting colorfastness.

Suggested Uses: Bags and softsided luggage.

FABRIC	960-Denier x 1080-Denier Textured Polyester			
FINISH	1.0-1.25 oz. Urethane Coated, DWR			
ITEM #	COLOR	PUT UP	WEIGHT	WIDTH
726420	Black	60 yd.	11 oz.	60 in.

Texas Cloth

FABRIC	600-Denier x 300-Denier Polyester			
FINISH	Embossed Vinyl Backing			

ITEM #	COLOR	PUT UP	WEIGHT	WIDTH
726271	Black	50 yd.	11.78 oz.	57 in.
726269	Burgundy	50 yd.	11.78 oz.	57 in.
726273	Charcoal	50 yd.	11.78 oz.	57 in.
726261	Coyote Brown	50 yd.	11.78 oz.	57 in.
726267	Forest Green	50 yd.	11.78 oz.	57 in.
726277	Light Navy	50 yd.	11.78 oz.	57 in.
726265	Orange	50 yd.	11.78 oz.	57 in.
726268	Purple	50 yd.	11.78 oz.	57 in.
726270	Red	50 yd.	11.78 oz.	57 in.
726266	Royal Blue	50 yd.	11.78 oz.	57 in.
726264	Tan	50 yd.	11.78 oz.	57 in.
726274	White	50 yd.	11.78 oz.	57 in.
726262	Woodland Camo	50 yd.	11.78 oz.	57 in.

AwnTex® 70

Ideal for awning and umbrella applications. AwnTex gives excellent shading advantages without trapping heat or airflow. Ultraviolet ray and mildew resistant.

AwnTex is infused with Microban® antimicrobial product protection, helping to provide an additional level of cleanliness protection that won't wash or wear away for the lifetime of the fabric. Microban protection inhibits the growth of stain and odor-causing bacteria, mold and mildew and works continuously, keeping fabrics cleaner for longer.

FABRIC	Vinyl Encapsulated Polyester				
FR STANDARDS MET	California State Fire Marshal Title 19; NFPA-701 (Test Method 1 & 2); ASTM E-84				
WARRANTY	5-Year				

ITEM #	STYLE #	COLOR	FABRIC COUNT	PUT UP	WEIGHT	WIDTH
863209	OF1	Almond	17 x 11	30 yd.	11.7 oz.	60 in.
863215	Z24	Ash Gray	17 x 11	30 yd.	11.7 oz.	60 in.
863225	EF1	Beige	17 x 11	30 yd.	11.7 oz.	60 in.
863201	Z81	Black	17 x 11	30 yd.	11.7 oz.	60 in.
863227	L41	Navy	17 x 11	30 yd.	11.7 oz.	60 in.
863203	HY0	Royal Blue	17 x 11	30 yd.	11.7 oz.	60 in.
863218	D70	Spruce Green	17 x 11	30 yd.	11.7 oz.	60 in.
863224	M97	Terra Cotta	17 x 11	30 yd.	11.7 oz.	60 in.
863206	OC2	White	17 x 11	30 yd.	11.7 oz.	60 in.

AwnTex® is a registered trademark of Glen Raven, Inc. Microban® is a registered trademark of Microban Products Company.

AwnTex® 120

Ideal for awning and umbrella applications. AwnTex gives excellent shading advantages without trapping heat or airflow. Ultraviolet ray and mildew resistant.

AwnTex is infused with Microban® antimicrobial product protection, helping to provide an additional level of cleanliness protection that won't wash or wear away for the lifetime of the fabric. Microban protection inhibits the growth of stain and odor-causing bacteria, mold and mildew and works continuously, keeping fabrics cleaner for longer.

FABRIC	Vinyl Encapsulated Polyester				
WARRANTY	5-Year				

ITEM #	STYLE #	COLOR	FABRIC COUNT	PUT UP	WEIGHT	WIDTH
863355	186	Almond	36 x 18	30 yd.	16.8 oz.	98 in.
863315	186	Almond	36 x 18	30 yd.	16.8 oz.	60 in.
863314	983	Almond/Brown Tweed	36 x 18	30 yd.	16.8 oz.	60 in.
863354	983	Almond/Brown Tweed	36 x 18	30 yd.	16.8 oz.	98 in.
863320	X11	Ash Gray	36 x 18	30 yd.	16.8 oz.	60 in.
863310	X04	Black	36 x 18	30 yd.	16.8 oz.	60 in.
863318	A20	Brown	36 x 18	30 yd.	16.8 oz.	60 in.
863350	KB2	Burgundy	36 x 18	30 yd.	16.8 oz.	60 in.
863309	812	Camel	36 x 18	30 yd.	16.8 oz.	60 in.
863311	G00	Royal Blue	36 x 18	30 yd.	16.8 oz.	60 in.

ITEM #	STYLE #	COLOR	FABRIC COUNT	PUT UP	WEIGHT	WIDTH
863340	C09	Spruce Green	36 x 18	30 yd.	16.8 oz.	60 in.
863339	984	Spruce Green/ Bittersweet Tweed	36 x 18	30 yd.	16.8 oz.	60 in.
863308	KB3	Terra Cotta	36 x 18	30 yd.	16.8 oz.	60 in.
863312	000	White	36 x 18	30 yd.	16.8 oz.	60 in.

AwnTex® is a registered trademark of Glen Raven, Inc. Microban® is a registered trademark of Microban Products Company.

AwnTex® 160

Ideal for awning and umbrella applications. AwnTex gives excellent shading advantages without trapping heat or airflow. Ultraviolet ray and mildew resistant.

AwnTex is infused with Microban® antimicrobial product protection, helping to provide an additional level of cleanliness protection that won't wash or wear away for the lifetime of the fabric. Microban protection inhibits the growth of stain and odor-causing bacteria, mold and mildew and works continuously, keeping fabrics cleaner for longer.

FABRIC	Vinyl Encapsulated Polyester
FR STANDARDS MET	California State Fire Marshal Title 19; NFPA-701 (Test Method 1 & 2); ASTM E-84
WARRANTY	5-Year

ITEM #	STYLE #	COLOR	FABRIC COUNT	PUT UP	WEIGHT	WIDTH
863406	ODZ	Alabaster	36 x 16	30 yd.	14.3 oz.	60 in.
863402	EF6	Beige	36 x 16	30 yd.	14.3 oz.	60 in.
863409	XMY	Black	36 x 16	30 yd.	14.3 oz.	60 in.
863403	EF7	Brown	36 x 16	30 yd.	14.3 oz.	60 in.
863410	DM3	Dark Green	36 x 16	30 yd.	14.3 oz.	60 in.
863408	EF8	Desert Tan	36 x 16	30 yd.	14.3 oz.	60 in.
863405	XM2	Gray	36 x 16	30 yd.	14.3 oz.	60 in.
863401	DM2	Pine Green	36 x 16	30 yd.	14.3 oz.	60 in.
863407	L42	Royal Blue	36 x 16	30 yd.	14.3 oz.	60 in.
863404	ODY	White	36 x 16	30 yd.	14.3 oz.	60 in.
863400	EF5	Winter Wheat	36 x 16	30 yd.	14.3 oz.	60 in.

AwnTex® is a registered trademark of Glen Raven, Inc. Microban® is a registered trademark of Microban Products Company.



Phifertex®

Phifertex is ideal for lawn and patio furniture, umbrellas, office furniture, orthopedic equipment, upholstery, safety vests, and unique heat-filtering awnings.

Phifertex is infused with Microban® antimicrobial product protection, helping to provide an additional level of cleanliness protection that won't wash or wear away for the lifetime of the fabric. Microban protection inhibits the growth of stain and odor-causing bacteria, mold and mildew and works continuously, keeping fabrics cleaner for longer. This product is GREENGUARD® certified for low chemical emissions. UL.Com/GG, UL2818.

FABRIC	Vinyl Encapsulated Polyester Yarns
FR STANDARDS MET	California Technical Bulletin 117, Section E
WARRANTY	3-Year

ITEM #	STYLE #	COLOR	FABRIC COUNT	PUT UP	WEIGHT	WIDTH
997145	186	Almond	17 x 11	60 yd.	11.7 oz.	54 in.
997150	X11	Ash Gray	17 x 11	60 yd.	11.7 oz.	54 in.
997152	X04	Black	17 x 11	60 yd.	11.7 oz.	54 in.
997148	800	Brown	17 x 11	60 yd.	11.7 oz.	54 in.
997149	812	Camel	17 x 11	60 yd.	11.7 oz.	54 in.
997235	X00	Grey Sand	17 x 11	60 yd.	11.7 oz.	54 in.
997147	G01	Navy	17 x 11	60 yd.	11.7 oz.	54 in.
997146	412	Orange	17 x 11	60 yd.	11.7 oz.	54 in.
997173	M96	Red	17 x 11	60 yd.	11.7 oz.	54 in.
997141	G00	Royal Blue	17 x 11	60 yd.	11.7 oz.	54 in.
997136	A40	Spice	17 x 11	60 yd.	11.7 oz.	54 in.
997171	C09	Spruce	17 x 11	60 yd.	11.7 oz.	54 in.
997142	000	White	17 x 11	60 yd.	11.7 oz.	54 in.
997143	406	Yellow	17 x 11	60 yd.	11.7 oz.	54 in.

997173 - Trivantage® makes no claim as to the colorfastness of M96 Red. Customer should determine suitability of fabric to needs.

Phifertex® is a registered trademark of Phifer Inc. Microban® is a registered trademark of Microban Products Company. GREENGUARD® is a registered trademark of GREENGUARD Environmental Institute.



ITEM #	STYLE #	COLOR	FABRIC COUNT	PUT UP	WEIGHT	WIDTH
997497	DAV	Spring Tweed Citronelle	42 x 14	60 yd.	16.5 oz. (+/- 0.5)	54 in.
997301	LBY	Straw Mat Blue	42 x 14	60 yd.	16.5 oz. (+/- 0.5)	54 in.
997129	OY3	Stucco	42 x 12	60 yd.	16.5 oz. (+/- 0.5)	54 in.
997472	LDC	Tweed Indigo	42 x 14	60 yd.	16.5 oz. (+/- 0.5)	54 in.
997471	DAH	Tweed Taffy	42 x 14	60 yd.	16.5 oz. (+/- 0.5)	54 in.
997121	000	White	42 x 12	60 yd.	16.5 oz. (+/- 0.5)	54 in.
997123	406	Yellow	42 x 12	60 yd.	16.5 oz. (+/- 0.5)	54 in.

Phifertex® is a registered trademark of Phifer Incorporated. Microban® is a registered trademark of Microban Products Company. GREENGUARD® is a registered trademark of GREENGUARD Environmental Institute.

Phifertex® Stripes

Phifertex is infused with Microban® antimicrobial product protection, helping to provide an additional level of cleanliness protection that won't wash or wear away for the lifetime of the fabric. Microban protection inhibits the growth of stain and odor-causing bacteria, mold and mildew and works continuously, keeping fabrics cleaner for longer. This product is GREENGUARD® certified for low chemical emissions. UL.Com/GG, UL2818.

FABRIC	Vinyl Encapsulated Polyester Yarns
FR STANDARDS MET	California Technical Bulletin 117, Section E
WARRANTY	3-Year

ITEM #	STYLE #	COLOR	FABRIC COUNT	PUT UP	WEIGHT	WIDTH
997429	GYO	Aquafino	42 x 14	60 yd.	16.5 oz. (+/- 0.5)	54 in.
997494	LEB	Bailey Stripe Aqua Shimmer	42 x 14	60 yd.	16.5 oz. (+/- 0.5)	54 in.
997493	DAW	Bailey Stripe Citronelle	42 x 14	60 yd.	16.5 oz. (+/- 0.5)	54 in.
997137	687	Charisma Citrus	42 x 14	60 yd.	16.5 oz. (+/- 0.5)	54 in.
997468	XUM	Coastline Peacock	42 x 14	60 yd.	16.5 oz. (+/- 0.5)	54 in.
997552	DJ5	Delray Stripe Conch	42 x 14	60 yd.	16.5 oz. (+/- 0.5)	54 in.
997551	DJ6	Delray Stripe Kiwi	42 x 14	60 yd.	16.5 oz. (+/- 0.5)	54 in.
997550	L38	Delray Stripe Poolside	42 x 14	60 yd.	16.5 oz. (+/- 0.5)	54 in.
997139	LAN	Leena Indigo	42 x 14	60 yd.	16.5 oz. (+/- 0.5)	54 in.
997619	NH4	Martindale Pewter	42 x 14	60 yd.	16.5 oz. (+/- 0.5)	54 in.
997614	EY1	Pulse Dahlia	42 x 14	60 yd.	16.5 oz. (+/- 0.5)	54 in.
997613	EY0	Pulse Kiwi	42 x 14	60 yd.	16.5 oz. (+/- 0.5)	54 in.
997473	DAI	Raleigh Stripe Willow	42 x 14	60 yd.	16.5 oz. (+/- 0.5)	54 in.
997433	KG3	Santiago Stripe	42 x 14	60 yd.	16.5 oz. (+/- 0.5)	54 in.
997475	NN5	Saylor Stripe Sepia	42 x 14	60 yd.	16.5 oz. (+/- 0.5)	54 in.
997466	XUQ	Skyline Stripe Verde	42 x 14	60 yd.	16.5 oz. (+/- 0.5)	54 in.
997138	DW3	Sumi Sea Mist	42 x 14	60 yd.	16.5 oz. (+/- 0.5)	54 in.
997616	YAC	Tempo Stone	42 x 14	60 yd.	16.5 oz. (+/- 0.5)	54 in.
997474	LDB	Trixie Stripe Myrtle	42 x 14	60 yd.	16.5 oz. (+/- 0.5)	54 in.
997618	NH3	Whatley Dune	42 x 14	60 yd.	16.5 oz. (+/- 0.5)	54 in.
997441	L09	Windsor Stripe Spa	42 x 14	60 yd.	16.5 oz. (+/- 0.5)	54 in.
997617	LBX	Winsted Stripe Beach	42 x 14	60 yd.	16.5 oz. (+/- 0.5)	54 in.

Phifertex® is a registered trademark of Phifer Incorporated. Microban® is a registered trademark of Microban Products Company. GREENGUARD® is a registered trademark of GREENGUARD Environmental Institute.

Phifertex® Plus

Designed especially for sling and umbrella applications.

Phifertex is infused with Microban® antimicrobial product protection, helping to provide an additional level of cleanliness protection that won't wash or wear away for the lifetime of the fabric. Microban protection inhibits the growth of stain and odor-causing bacteria, mold and mildew and works continuously, keeping fabrics cleaner for longer. This product is GREENGUARD® certified.

FABRIC	Vinyl Encapsulated Polyester Yarns
FR STANDARDS MET	California Technical Bulletin 117, Section E
WARRANTY	3-Year

ITEM #	STYLE #	COLOR	FABRIC COUNT	PUT UP	WEIGHT	WIDTH
997298	X04	Black	42 x 12	60 yd.	16.5 oz. (+/- 0.5)	54 in.
997299	BH4	Burlap	42 x 12	60 yd.	16.5 oz. (+/- 0.5)	54 in.
997557	DJ7	Dupione Kiwi	42 x 12	60 yd.	16.5 oz. (+/- 0.5)	54 in.
997555	L37	Dupione Poolside	42 x 12	60 yd.	16.5 oz. (+/- 0.5)	54 in.
997316	L96	Dupione Sapphire	42 x 14	60 yd.	16.5 oz. (+/- 0.5)	54 in.
997315	KT1	Dupione Spice	42 x 14	60 yd.	16.5 oz. (+/- 0.5)	54 in.
997289	DB6	Garden Green	42 x 12	60 yd.	16.5 oz. (+/- 0.5)	54 in.
997108	X00	Grey Sand	42 x 12	60 yd.	16.5 oz. (+/- 0.5)	54 in.
997122	CL1	Holly Green	42 x 12	60 yd.	16.5 oz. (+/- 0.5)	54 in.
997464	XUP	Metallica Platinum	42 x 14	60 yd.	16.5 oz. (+/- 0.5)	54 in.
997302	KK3	Metallica Salsa	42 x 12	60 yd.	16.5 oz. (+/- 0.5)	54 in.
997314	XXG	Metallica Smoke	42 x 14	60 yd.	16.5 oz. (+/- 0.5)	54 in.
997300	OHK	Metallica White	42 x 14	60 yd.	16.5 oz. (+/- 0.5)	54 in.
997124	GP5	Navy Pier	42 x 12	60 yd.	16.5 oz. (+/- 0.5)	54 in.
997125	G00	Royal Blue	42 x 12	60 yd.	16.5 oz. (+/- 0.5)	54 in.
997295	KG4	Salsa	42 x 12	60 yd.	16.5 oz. (+/- 0.5)	54 in.
997288	KF4	Snappy	42 x 12	60 yd.	16.5 oz. (+/- 0.5)	54 in.
997498	LEA	Spring Tweed Aqua Shimmer	42 x 14	60 yd.	16.5 oz. (+/- 0.5)	54 in.



SheerWeave® 2000-01

SheerWeave sun control fabrics offer exciting alternatives to ordinary window coverings. The unique light-filtering qualities of SheerWeave help reduce fading of drapes, carpets and interior furnishings while continuing to offer a view of the outside.

A basket weave designed expressly for applications that require a more opaque and nondirectional fabric. An ideal fabric for roman shades, roll-ups and vertical blinds. Average openness 5%.

SheerWeave is infused with Microban® antimicrobial product protection, helping to provide an additional level of cleanliness protection that won't wash or wear away for the lifetime of the fabric. Microban protection inhibits the growth of stain and odor-causing bacteria, mold and mildew and works continuously, keeping fabrics cleaner for longer. This product is GREENGUARD® and GREENGUARD® Gold certified.

FABRIC	Vinyl Encapsulated Fiberglass Yarns
FR STANDARDS MET	California U.S. Title 19 (small scale), NFPA 701-2004 TM#1 (small scale), NFPA 101 (Class A Rating), IBC Section 903.1 (Class A Rating), BS 5867 2008 Part 2 Type B Performance, NFPA 701 TM#2 (large scale), CAN/ULC-S109 (large and small scale), ASTM E 84 (Class 1) and CAN/CGSB2-4.162-M80
WARRANTY	10-Year Interior; 5-Year Exterior

SheerWeave® 1000

SheerWeave sun control fabrics offer exciting alternatives to ordinary window coverings. The unique light-filtering qualities of SheerWeave help reduce fading of drapes, carpets and interior furnishings while continuing to offer a view of the outside.

A ribbed-weave fiberglass fabric that offers substantial shading while allowing excellent outward visibility and daytime privacy. Average openness 25%.

For Use In: Roll-up shades, Roman shades, folding shades, pleated shades, vertical blinds, drapes, sheers and screens.

SheerWeave is infused with Microban® antimicrobial product protection, helping to provide an additional level of cleanliness protection that won't wash or wear away for the lifetime of the fabric. Microban protection inhibits the growth of stain and odor-causing bacteria, mold and mildew and works continuously, keeping fabrics cleaner for longer. This product is GREENGUARD® and GREENGUARD® Gold certified.

FABRIC	Vinyl Encapsulated Fiberglass Yarns
FR STANDARDS MET	California U.S. Title 19 (small scale), NFPA 701-2004 TM#1 (small scale), NFPA 101 (Class A Rating), IBC Section 903.1 (Class A Rating), BS 5867 2008 Part 2 Type B Performance and NFPA 701 TM#2 (large scale), and ASTM E 84 (Class 1)
WARRANTY	10-Year Interior; 5-Year Exterior

ITEM #	STYLE #	COLOR	PUT UP	WEIGHT	WIDTH
901965	P03	Antique White	30 yd.	8.8 oz.	36 in.
901970	P03	Antique White	30 yd.	8.8 oz.	72 in.
901981	P03	Antique White	30 yd.	8.8 oz.	84 in.
901973	P02	White	30 yd.	8.8 oz.	36 in.
901977	P02	White	30 yd.	8.8 oz.	72 in.
901980	P02	White	30 yd.	8.8 oz.	84 in.

ITEM #	STYLE #	COLOR	PUT UP	WEIGHT	WIDTH
901844	Q05	Bone	30 yd.	14.26 oz.	63 in.
901856	Q05	Bone	30 yd.	14.26 oz.	98 in.
901845	Q06	Bone/Platinum	30 yd.	14.26 oz.	63 in.
901857	Q06	Bone/Platinum	30 yd.	14.26 oz.	98 in.
901500	Q10	Bronze	30 yd.	14.26 oz.	126 in.
901847	Q10	Bronze	30 yd.	14.26 oz.	63 in.
901858	Q10	Bronze	30 yd.	14.26 oz.	98 in.
901860	V21	Charcoal	30 yd.	14.26 oz.	98 in.
901851	V24	Charcoal/Chestnut	30 yd.	14.26 oz.	63 in.
901862	V24	Charcoal/Chestnut	30 yd.	14.26 oz.	98 in.
901861	V22	Charcoal/Gray	30 yd.	14.26 oz.	98 in.
901848	V04	Platinum	30 yd.	14.26 oz.	63 in.
901859	V04	Platinum	30 yd.	14.26 oz.	98 in.
901501	P02	White	30 yd.	14.26 oz.	126 in.
901799	P02	White	30 yd.	14.26 oz.	63 in.
901852	P02	White	30 yd.	14.26 oz.	98 in.
901842	P04	White/Bone	30 yd.	14.26 oz.	63 in.
901853	P04	White/Bone	30 yd.	14.26 oz.	98 in.
901843	P05	White/Platinum	30 yd.	14.26 oz.	63 in.
901855	P05	White/Platinum	30 yd.	14.26 oz.	98 in.

SheerWeave® is a registered trademark of Phifer Inc. Microban® is a registered trademark of Microban Products Company. GREENGUARD® is a registered trademark of GREENGUARD Environmental Institute.

SheerWeave® is a registered trademark of Phifer Inc. Microban® is a registered trademark of Microban Products Company. GREENGUARD® is a registered trademark of GREENGUARD Environmental Institute.

SheerWeave® 2100-01

SheerWeave sun control fabrics offer exciting alternatives to ordinary window coverings. The unique light-filtering qualities of SheerWeave help reduce fading of drapes, carpets and interior furnishings while continuing to offer a view of the outside.

A basket weave designed expressly for applications that require a more opaque and nondirectional fabric. An ideal fabric for roman shades, roll-ups and vertical blinds. Average openness 10%.

SheerWeave is infused with Microban® antimicrobial product protection, helping to provide an additional level of cleanliness protection that won't wash or wear away for the lifetime of the fabric. Microban protection inhibits the growth of stain and odor-causing bacteria, mold and mildew and works continuously, keeping fabrics cleaner for longer. This product is GREENGUARD® and GREENGUARD® Gold certified.

FABRIC	Vinyl Encapsulated Fiberglass Yarns
FR STANDARDS MET	California U.S. Title 19 (small scale), NFPA 701-2004 TM#1 (small scale), NFPA 101 (Class A Rating), IBC Section 903.1 (Class A Rating), BS 5867 2008 Part 2 Type B Performance, NFPA 701 TM#2 (large scale), CAN/ULC-S109 (large and small scale), ASTM E 84 (Class 1) and CAN/CGSB2-4.162-M80
WARRANTY	10-Year Interior; 5-Year Exterior

ITEM #	STYLE #	COLOR	PUT UP	WEIGHT	WIDTH
901866	Q05	Bone	30 yd.	12.4 oz.	63 in.
901877	Q05	Bone	30 yd.	12.4 oz.	98 in.
901867	Q06	Bone/Platinum	30 yd.	12.4 oz.	63 in.
901878	Q06	Bone/Platinum	30 yd.	12.4 oz.	98 in.
901868	Q10	Bronze	30 yd.	12.4 oz.	63 in.
901879	Q10	Bronze	30 yd.	12.4 oz.	98 in.
901871	V21	Charcoal	30 yd.	12.4 oz.	63 in.
901882	V21	Charcoal	30 yd.	12.4 oz.	98 in.
901873	V24	Charcoal/Chestnut	30 yd.	12.4 oz.	63 in.
901884	V24	Charcoal/Chestnut	30 yd.	12.4 oz.	98 in.
901872	V22	Charcoal/Gray	30 yd.	12.4 oz.	63 in.
901883	V22	Charcoal/Gray	30 yd.	12.4 oz.	98 in.
901869	V04	Platinum	30 yd.	12.4 oz.	63 in.
901880	V04	Platinum	30 yd.	12.4 oz.	98 in.
901863	P02	White	30 yd.	12.4 oz.	63 in.
901874	P02	White	30 yd.	12.4 oz.	98 in.
901864	P04	White/Bone	30 yd.	12.4 oz.	63 in.
901875	P04	White/Bone	30 yd.	12.4 oz.	98 in.
901865	P05	White/Platinum	30 yd.	12.4 oz.	63 in.
901876	P05	White/Platinum	30 yd.	12.4 oz.	98 in.

SheerWeave® is a registered trademark of Phifer Inc. Microban® is a registered trademark of Microban Products Company. GREENGUARD® is a registered trademark of GREENGUARD Environmental Institute.

SheerWeave® 2360

Manufactured with ease of fabrication in mind, SheerWeave 2360 is a basket weave designed expressly for those applications that require a more opaque and non-directional fabric. An ideal fabric for Roman and pull-up shades. Average openness 10%.

SheerWeave is infused with Microban® antimicrobial product protection, helping to provide an additional level of cleanliness protection that won't wash or wear away for the lifetime of the fabric. Microban protection inhibits the growth of stain and odor-causing bacteria, mold and mildew and works continuously, keeping fabrics cleaner for longer. This product is GREENGUARD® and GREENGUARD® Gold certified.

FABRIC	Vinyl Encapsulated Fiberglass Yarns
FR STANDARDS MET	California U.S. Title 19 (small scale), NFPA 701-2004 TM#1 (small scale), NFPA 101 (Class A Rating), IBC Section 903.1 (Class A Rating), BS 5867 2008 Part 2 Type B Performance, NFPA 701 TM#2 (large scale), CAN/ULC-S109-03 (large and small scale), ASTM E 84 (Class 1), and CAN/CGSB2-4.162-M80
WARRANTY	10-Year Interior; 5-Year Exterior

ITEM #	STYLE #	COLOR	PUT UP	WEIGHT	WIDTH
901771	Q20	Beige	30 yd.	10.5 oz.	98 in.
901782	V21	Charcoal	30 yd.	10.5 oz.	63 in.
901776	V21	Charcoal	30 yd.	10.5 oz.	98 in.
901784	V24	Charcoal/Chestnut	30 yd.	10.5 oz.	63 in.
901770	V24	Charcoal/Chestnut	30 yd.	10.5 oz.	98 in.
901785	V22	Charcoal/Gray	30 yd.	10.5 oz.	63 in.
901778	V22	Charcoal/Gray	30 yd.	10.5 oz.	98 in.
901780	P12	Oyster	30 yd.	10.5 oz.	63 in.
901772	P12	Oyster	30 yd.	10.5 oz.	98 in.
901783	P13	Oyster/Beige	30 yd.	10.5 oz.	63 in.
901773	P13	Oyster/Beige	30 yd.	10.5 oz.	98 in.
901775	P14	Oyster/Pearl Gray	30 yd.	10.5 oz.	98 in.
901781	V20	Pearl Gray	30 yd.	10.5 oz.	63 in.
901774	V20	Pearl Gray	30 yd.	10.5 oz.	98 in.

SheerWeave® is a registered trademark of Phifer Inc. Microban® is a registered trademark of Microban Products Company. GREENGUARD® is a registered trademark of GREENGUARD Environmental Institute.

SheerWeave® 2390

Manufactured with ease of fabrication in mind, SheerWeave 2390 is a basket weave designed expressly for those applications that require a more opaque and non-directional fabric. An ideal fabric for Roman and pull-up shades. Average openness 5%.

SheerWeave is infused with Microban® antimicrobial product protection, helping to provide an additional level of cleanliness protection that won't wash or wear away for the lifetime of the fabric. Microban protection inhibits the growth of stain and odor-causing bacteria, mold and mildew and works continuously, keeping fabrics cleaner for longer. This product is GREENGUARD® and GREENGUARD® Gold certified.

FABRIC	Vinyl Encapsulated Fiberglass Yarns
FR STANDARDS MET	California U.S. Title 19 (small scale), NFPA 701-2004 TM#1 (small scale), NFPA 101 (Class A Rating), IBC Section 903.1 (Class A Rating), BS 5867 2008 Part 2 Type B Performance, NFPA 701 TM#2 (large scale), CAN/ULC-S109-03 (large and small scale), ASTM E 84 (Class 1), and CAN/CGSB2-4.162-M80
WARRANTY	10-Year Interior; 5-Year Exterior

ITEM #	STYLE #	COLOR	PUT UP	WEIGHT	WIDTH
901796	Q20	Beige	30 yd.	11.8 oz.	126 in.
901753	Q20	Beige	30 yd.	11.8 oz.	63 in.
901747	Q20	Beige	30 yd.	11.8 oz.	98 in.
901754	Q21	Beige/Pearl Gray	30 yd.	11.8 oz.	63 in.
901749	Q21	Beige/Pearl Gray	30 yd.	11.8 oz.	98 in.
901793	V21	Charcoal	30 yd.	11.8 oz.	126 in.
901743	V21	Charcoal	30 yd.	11.8 oz.	98 in.
901757	V32	Charcoal/Alpaca	30 yd.	11.8 oz.	98 in.
901790	V24	Charcoal/Chestnut	30 yd.	11.8 oz.	126 in.
901755	V24	Charcoal/Chestnut	30 yd.	11.8 oz.	63 in.
901794	V22	Charcoal/Gray	30 yd.	11.8 oz.	126 in.
901741	V22	Charcoal/Gray	30 yd.	11.8 oz.	98 in.
901752	P12	Oyster	30 yd.	11.8 oz.	63 in.
901745	P12	Oyster	30 yd.	11.8 oz.	98 in.
901795	P13	Oyster/Beige	30 yd.	11.8 oz.	126 in.
901751	P13	Oyster/Beige	30 yd.	11.8 oz.	63 in.
901742	P13	Oyster/Beige	30 yd.	11.8 oz.	98 in.
901792	P14	Oyster/Pearl Gray	30 yd.	11.8 oz.	126 in.
901750	P14	Oyster/Pearl Gray	30 yd.	11.8 oz.	63 in.
901748	P14	Oyster/Pearl Gray	30 yd.	11.8 oz.	98 in.

SheerWeave® is a registered trademark of Phifer Inc. Microban® is a registered trademark of Microban Products Company. GREENGUARD® is a registered trademark of GREENGUARD Environmental Institute.

SheerWeave® 2390 Performance +

SheerWeave Performance + takes the performance of a traditional SheerWeave fabric "plus" the highly reflective properties of metalization and combines them to achieve the ultimate in sun control protection.

SheerWeave is infused with Microban® antimicrobial product protection, helping to provide an additional level of cleanliness protection that won't wash or wear away for the lifetime of the fabric. Microban protection inhibits the growth of stain and odor-causing bacteria, mold and mildew and works continuously, keeping fabrics cleaner for longer. This product is GREENGUARD® and GREENGUARD® Gold certified.

FABRIC	Metalized Vinyl Encapsulated Fiberglass Yarns
FR STANDARDS MET	California U.S. Title 19 (small scale), ASTM E 84 (Class 1), NFPA 701-2004 TM#1 (small scale), NFPA 101 (Class A Rating), IBC Section 903.1 (Class A Rating), BS 5867 2008 Part 2 Type B Performance, NFPA 701 TM#2 (large scale), CAN/ ULC-S 109 (large and small scale) and CAN/CGSB2-4.162-M80
WARRANTY	5 Year Interior Only

ITEM #	STYLE #	COLOR	PUT UP	WEIGHT	WIDTH
901765	Q20	Beige	30 yd.	11.8 oz.	63 in.
901762	Q20	Beige	30 yd.	11.8 oz.	96 in.
901768	Q21	Beige/Pearl Gray	30 yd.	11.8 oz.	96 in.
901763	V22	Charcoal	30 yd.	11.8 oz.	63 in.
901767	V21	Charcoal	30 yd.	11.8 oz.	96 in.
901760	P13	Oyster/Beige	30 yd.	11.8 oz.	96 in.
901766	P14	Oyster/Pearl Gray	30 yd.	11.8 oz.	96 in.
901761	V20	Pearl Gray	30 yd.	11.8 oz.	96 in.

The metalized coating is fragile and must be handled with care to avoid damage. Do not scrub. Do not use tape, solvents or abrasive cleaners which could damage the fabric coating. Clean with a damp soft cloth using a mild detergent. Rinse with clean water and allow blind to dry in the down position. Do not slide metalized side across surfaces or into the cardboard tube without protective plastic wrapping. Do not use Radio Frequency sealing equipment on metalized fabric. Use only heat bars or ultrasonic sealing equipment for welding.

SheerWeave® is a registered trademark of Phifer Inc. Microban® is a registered trademark of Microban Products Company. GREENGUARD® is a registered trademark of GREENGUARD Environmental Institute.

SheerWeave® 2410

A full basket weave designed expressly for those applications that require a more opaque and non-directional fabric, for example: roll-up shades, roller shades, Roman shades and vertical blinds. Average openness 3%.

SheerWeave is infused with Microban® antimicrobial product protection, helping to provide an additional level of cleanliness protection that won't wash or wear away for the lifetime of the fabric. Microban protection inhibits the growth of stain and odor-causing bacteria, mold and mildew and works continuously, keeping fabrics cleaner for longer. This product is GREENGUARD® and GREENGUARD® Gold certified.

FABRIC	Vinyl Encapsulated Fiberglass Yarns
FR STANDARDS MET	California U.S. Title 19 (small scale), NFPA 701-2004 TM#1 (small scale), NFPA 101 (Class A Rating), IBC Section 903.1 (Class A Rating), BS 5867 2008 Part 2 Type B Performance, NFPA 701 TM#2 (large scale), CAN/ULC-S109-03 (large and small scale), ASTM E 84 (Class 1), and CAN/CGSB2-4.162-M80
WARRANTY	10-Year Interior, 5-Year Exterior

ITEM #	STYLE #	COLOR	PUT UP	WEIGHT	WIDTH
901736	Q20	Beige	30 yd.	14.1 oz.	126 in.
901717	Q20	Beige	30 yd.	14.1 oz.	63 in.
901725	Q20	Beige	30 yd.	14.1 oz.	98 in.
901713	Q21	Beige/Pearl Gray	30 yd.	14.1 oz.	63 in.
901727	Q21	Beige/Pearl Gray	30 yd.	14.1 oz.	98 in.
901723	V21	Charcoal	30 yd.	14.1 oz.	98 in.
901733	V32	Charcoal/Alpaca	30 yd.	14.1 oz.	63 in.
901729	V32	Charcoal/Alpaca	30 yd.	14.1 oz.	98 in.
901730	V24	Charcoal/Chestnut	30 yd.	14.1 oz.	126 in.
901714	V24	Charcoal/Chestnut	30 yd.	14.1 oz.	63 in.
901722	V24	Charcoal/Chestnut	30 yd.	14.1 oz.	98 in.
901716	V22	Charcoal/Gray	30 yd.	14.1 oz.	63 in.
901724	V22	Charcoal/Gray	30 yd.	14.1 oz.	98 in.
901731	P12	Oyster	30 yd.	14.1 oz.	126 in.
901718	P12	Oyster	30 yd.	14.1 oz.	63 in.
901737	P12	Oyster	30 yd.	14.1 oz.	98 in.
901732	P13	Oyster/Beige	30 yd.	14.1 oz.	126 in.
901719	P13	Oyster/Beige	30 yd.	14.1 oz.	63 in.
901721	P13	Oyster/Beige	30 yd.	14.1 oz.	98 in.
901734	P14	Oyster/Pearl Gray	30 yd.	14.1 oz.	126 in.
901726	P14	Oyster/Pearl Gray	30 yd.	14.1 oz.	98 in.
901720	V20	Pearl Gray	30 yd.	14.1 oz.	63 in.
901728	V20	Pearl Gray	30 yd.	14.1 oz.	98 in.

SheerWeave® is a registered trademark of Phifer Inc. Microban® is a registered trademark of Microban Products Company. GREENGUARD® is a registered trademark of GREENGUARD Environmental Institute.

SheerWeave® 2410 Performance +

SheerWeave Performance + takes the performance of a traditional SheerWeave fabric "plus" the highly reflective properties of metallization and combines them to achieve the ultimate in sun control protection.

SheerWeave is infused with Microban® antimicrobial product protection, helping to provide an additional level of cleanliness protection that won't wash or wear away for the lifetime of the fabric. Microban protection inhibits the growth of stain and odor-causing bacteria, mold and mildew and works continuously, keeping fabrics cleaner for longer. This product is GREENGUARD® and GREENGUARD® Gold certified.

FABRIC	Metalized Vinyl Encapsulated Fiberglass Yarns
FR STANDARDS MET	California U.S. Title 19 (small scale), ASTM E 84 (Class 1), NFPA 701-2004 TM#1 (small scale), NFPA 101 (Class A Rating), IBC Section 903.1 (Class A Rating), BS 5867 2008 Part 2 Type B Performance, NFPA 701 TM#2 (large scale), CAN/ULC-S 109 (large and small scale) and CAN/CGSB2-4.162-M80
WARRANTY	5 Year Interior Only

ITEM #	STYLE #	COLOR	PUT UP	WEIGHT	WIDTH
901764	V21	Charcoal	30 yd.	14.1 oz.	96 in.

The metalized coating is fragile and must be handled with care to avoid damage. Do not scrub. Do not use tape, solvents or abrasive cleaners which could damage the fabric coating. Clean with a damp soft cloth using a mild detergent. Rinse with clean water and allow blind to dry in the down position. Do not slide metalized side across surfaces or into the cardboard tube without protective plastic wrapping. Do not use Radio Frequency sealing equipment on metalized fabric. Use only heat bars or ultrasonic sealing equipment for welding.

SheerWeave® is a registered trademark of Phifer Inc. Microban® is a registered trademark of Microban Products Company. GREENGUARD® is a registered trademark of GREENGUARD Environmental Institute.

SheerWeave® 2500

This full basket weave is designed for those applications that require more opaque and non-directional fabric. Ideal for roll-up shades, Roman shades and vertical blinds. Average openness 1%.

SheerWeave is infused with Microban® antimicrobial product protection, helping to provide an additional level of cleanliness protection that won't wash or wear away for the lifetime of the fabric. Microban protection inhibits the growth of stain and odor-causing bacteria, mold and mildew and works continuously, keeping fabrics cleaner for longer. This product is GREENGUARD® and GREENGUARD® Gold certified.

FABRIC	Vinyl Encapsulated Fiberglass Yarns
FR STANDARDS MET	California U.S. Title 19 (small scale), NFPA 701-2004 TM#1 (small scale), NFPA 101 (Class A Rating), IBC Section 903.1 (Class A Rating), BS 5867 2008 Part 2 Type B Performance, NFPA 701 TM#2 (large scale), CAN/ULC-S109-03 (large and small scale), ASTM E 84 (Class 1), and CAN/CGSB2-4.162-M80
WARRANTY	10-Year Interior; 5-Year Exterior

ITEM #	STYLE #	COLOR	PUT UP	WEIGHT	WIDTH
902505	Q20	Beige	30 yd.	16.25 oz.	98 in.
902512	Q21	Beige/Pearl Gray	30 yd.	16.25 oz.	126 in.
902492	Q21	Beige/Pearl Gray	30 yd.	16.25 oz.	63 in.
902506	Q21	Beige/Pearl Gray	30 yd.	16.25 oz.	98 in.
902503	V21	Charcoal	30 yd.	16.25 oz.	98 in.
902495	V24	Charcoal/Chestnut	30 yd.	16.25 oz.	63 in.
902504	V24	Charcoal/Chestnut	30 yd.	16.25 oz.	98 in.
902510	V22	Charcoal/Gray	30 yd.	16.25 oz.	126 in.
902600	P12	Oyster	30 yd.	16.25 oz.	126 in.
902491	P12	Oyster	30 yd.	16.25 oz.	63 in.
902501	P12	Oyster	30 yd.	16.25 oz.	98 in.
902490	P13	Oyster/Beige	30 yd.	16.25 oz.	63 in.
902500	P13	Oyster/Beige	30 yd.	16.25 oz.	98 in.
902502	P14	Oyster/Pearl Gray	30 yd.	16.25 oz.	98 in.
902507	V20	Pearl/Gray	30 yd.	16.25 oz.	98 in.

SheerWeave® is a registered trademark of Phifer Inc. Microban® is a registered trademark of Microban Products Company. GREENGUARD® is a registered trademark of GREENGUARD Environmental Institute.

SheerWeave® 2701

This lightweight fiberglass fabric is woven from a unique twill pattern that displaces the individual yarns to create a two-sided fabric for maximum performance in heat reduction, glare reduction and improved visibility. Average openness 1%.

SheerWeave is infused with Microban® antimicrobial product protection, helping to provide an additional level of cleanliness protection that won't wash or wear away for the lifetime of the fabric. Microban protection inhibits the growth of stain and odor-causing bacteria, mold and mildew and works continuously, keeping fabrics cleaner for longer. This product is GREENGUARD® and GREENGUARD® Gold certified.

FABRIC	Vinyl Encapsulated Fiberglass Yarns
FR STANDARDS MET	California U.S. Title 19 (small scale), NFPA 701-2004 TM#1 (small scale), NFPA 101 (Class A Rating), IBC Section 903.1 (Class A Rating), BS 5867 2008 Part 2 Type B Performance, NFPA 701 TM#2 (large scale), CAN/ULC-S 109-03 (large and small scale), ASTM E 84 (Class 1), and CAN/CGSB2-4. 162-M80
WARRANTY	10-Year Interior; 5-Year Exterior

ITEM #	STYLE #	COLOR	PUT UP	WEIGHT	WIDTH
901712	P12	Oyster	30 yd.	14.6 oz.	126 in.
901703	P13	Oyster/Beige	30 yd.	14.6 oz.	126 in.
902185	P13	Oyster/Beige	30 yd.	14.6 oz.	98 in.
901696	P28	Oyster/Charcoal	30 yd.	14.6 oz.	126 in.
902184	P28	Oyster/Charcoal	30 yd.	14.6 oz.	63 in.
902187	P28	Oyster/Charcoal	30 yd.	14.6 oz.	98 in.
901695	P92	Oyster/Chestnut	30 yd.	14.6 oz.	126 in.
902181	P92	Oyster/Chestnut	30 yd.	14.6 oz.	63 in.
902186	P92	Oyster/Chestnut	30 yd.	14.6 oz.	98 in.
902176	P14	Oyster/Pearl Gray	30 yd.	14.6 oz.	126 in.
902194	P14	Oyster/Pearl Gray	30 yd.	14.6 oz.	63 in.
902195	P14	Oyster/Pearl Gray	30 yd.	14.6 oz.	98 in.

SheerWeave® is a registered trademark of Phifer Inc. Microban® is a registered trademark of Microban Products Company. GREENGUARD® is a registered trademark of GREENGUARD Environmental Institute.

SheerWeave® 2703

This lightweight fiberglass fabric is woven from a unique twill pattern that displaces the individual yarns to create a two-sided fabric for maximum performance in heat reduction, glare reduction and improved visibility. Average openness 3%.

SheerWeave is infused with Microban® antimicrobial product protection, helping to provide an additional level of cleanliness protection that won't wash or wear away for the lifetime of the fabric. Microban protection inhibits the growth of stain and odor-causing bacteria, mold and mildew and works continuously, keeping fabrics cleaner for longer. This product is GREENGUARD® and GREENGUARD® Gold certified.

FABRIC	Vinyl Encapsulated Fiberglass Yarns
FR STANDARDS MET	California U.S. Title 19 (small scale), NFPA 701-2004 TM#1 (small scale), NFPA 101 (Class A Rating), IBC Section 903.1 (Class A Rating), BS 5867 2008 Part 2 Type B Performance, NFPA 701 TM#2 (large scale), CAN/ULC-S 109-03 (large and small scale), ASTM E 84 (Class 1), and CAN/CGSB2-4. 162-M80
WARRANTY	10-Year Interior; 5-Year Exterior

ITEM #	STYLE #	COLOR	PUT UP	WEIGHT	WIDTH
901680	P12	Oyster	30 yd.	14 oz.	63 in.
901683	P13	Oyster/Beige	30 yd.	14 oz.	63 in.
901692	P13	Oyster/Beige	30 yd.	14 oz.	98 in.
901681	P28	Oyster/Charcoal	30 yd.	14 oz.	63 in.
901682	P92	Oyster/Chestnut	30 yd.	14 oz.	63 in.
901691	P92	Oyster/Chestnut	30 yd.	14 oz.	98 in.
901690	P91	Oyster/Pewter	30 yd.	14 oz.	98 in.

SheerWeave® is a registered trademark of Phifer Inc. Microban® is a registered trademark of Microban Products Company. GREENGUARD® is a registered trademark of GREENGUARD Environmental Institute.

SheerWeave® 2705

This lightweight fiberglass fabric is woven from a unique twill pattern that displaces the individual yarns to create a two-sided fabric for maximum performance in heat reduction, glare reduction and improved visibility. Average openness 5%.

SheerWeave is infused with Microban® antimicrobial product protection, helping to provide an additional level of cleanliness protection that won't wash or wear away for the lifetime of the fabric. Microban protection inhibits the growth of stain and odor-causing bacteria, mold and mildew and works continuously, keeping fabrics cleaner for longer. This product is GREENGUARD® and GREENGUARD® Gold certified.

FABRIC	Vinyl Encapsulated Fiberglass Yarns
FR STANDARDS MET	California U.S. Title 19 (small scale), NFPA 701-2004 TM#1 (small scale), NFPA 101 (Class A Rating), IBC Section 903.1 (Class A Rating), BS 5867 2008 Part 2 Type B Performance, NFPA 701 TM#2 (large scale), CAN/ULC-S 109-03 (large and small scale), ASTM E 84 (Class 1), and CAN/CGSB2-4. 162-M80
WARRANTY	10-Year Interior; 5-Year Exterior

ITEM #	STYLE #	COLOR	PUT UP	WEIGHT	WIDTH
901699	P12	Oyster	30 yd.	11.8 oz.	126 in.
901705	P12	Oyster	30 yd.	11.8 oz.	63 in.
901700	P12	Oyster	30 yd.	11.8 oz.	98 in.
901688	P13	Oyster/Beige	30 yd.	11.8 oz.	98 in.

ITEM #	STYLE #	COLOR	PUT UP	WEIGHT	WIDTH
901698	P28	Oyster/Charcoal	30 yd.	11.8 oz.	126 in.
901706	P28	Oyster/Charcoal	30 yd.	11.8 oz.	63 in.
901701	P28	Oyster/Charcoal	30 yd.	11.8 oz.	98 in.
901697	P92	Oyster/Chestnut	30 yd.	11.8 oz.	126 in.
901704	p92	Oyster/Chestnut	30 yd.	11.8 oz.	63 in.
901707	P92	Oyster/Chestnut	30 yd.	11.8 oz.	98 in.
901689	P14	Oyster/Pearl Gray	30 yd.	11.8 oz.	126 in.

SheerWeave® is a registered trademark of Phifer Inc. Microban® is a registered trademark of Microban Products Company. GREENGUARD® is a registered trademark of GREENGUARD Environmental Institute.

SheerWeave® 2710

This lightweight fiberglass fabric is woven from a unique twill pattern that displaces the individual yarns to create a two-sided fabric for maximum performance in heat reduction, glare reduction and improved visibility. Average openness 10%.

SheerWeave is infused with Microban® antimicrobial product protection, helping to provide an additional level of cleanliness protection that won't wash or wear away for the lifetime of the fabric. Microban protection inhibits the growth of stain and odor-causing bacteria, mold and mildew and works continuously, keeping fabrics cleaner for longer. This product is GREENGUARD® and GREENGUARD® Gold certified.

FABRIC	Vinyl Encapsulated Fiberglass Yarns
FR STANDARDS MET	California U.S. Title 19 (small scale), NFPA 701-2004 TM#1 (small scale), NFPA 101 (Class A Rating), IBC Section 903.1 (Class A Rating), BS 5867 2008 Part 2 Type B Performance, NFPA 701 TM#2 (large scale), CAN/ULC-S 109-03 (large and small scale), ASTM E 84 (Class 1), and CAN/CGSB2-4. 162-M80
WARRANTY	10-Year Interior; 5-Year Exterior

ITEM #	STYLE #	COLOR	PUT UP	WEIGHT	WIDTH
901711	P28	Oyster/Charcoal	30 yd.	10.4 oz.	98 in.
901710	P92	Oyster/Chestnut	30 yd.	10.4 oz.	98 in.

SheerWeave® is a registered trademark of Phifer Inc. Microban® is a registered trademark of Microban Products Company. GREENGUARD® is a registered trademark of GREENGUARD Environmental Institute.

SheerWeave® 3000

An elegant and exquisite shading fabric. This style is ideal for roller shades, roman shades and a variety of other interior sun control applications. Average openness 14%.

SheerWeave is infused with Microban® antimicrobial product protection, helping to provide an additional level of cleanliness protection that won't wash or wear away for the lifetime of the fabric. Microban protection inhibits the growth of stain and odor-causing bacteria, mold and mildew and works continuously, keeping fabrics cleaner for longer. This product is GREENGUARD® and GREENGUARD® Gold certified.

FABRIC	Vinyl Encapsulated Fiberglass/Polyester Yarns
FR STANDARDS MET	NFPA 701-2004 TM#1 (small scale), NFPA 101 (Class A Rating), IBC Section 903.1 (Class A Rating) and NFPA 701 TM#2 (large scale), ASTM E 84 (Class 1)
WARRANTY	10-Year Interior; 5-Year Exterior

ITEM #	STYLE #	COLOR	PUT UP	WEIGHT	WIDTH
902014	Q04	Chocolate	30 yd.	13.46 oz.	72 in.
902081	Q04	Chocolate	30 yd.	13.46 oz.	96 in.
902085	Q02	Custard Cream	30 yd.	13.46 oz.	96 in.
902027	Q18	Espresso	30 yd.	13.46 oz.	72 in.
902099	Q18	Espresso	30 yd.	13.46 oz.	96 in.
902072	Q19	Honey Sage	30 yd.	13.46 oz.	72 in.
902111	Q19	Honey Sage	30 yd.	13.46 oz.	96 in.
902084	Q01	Mushroom Sand	30 yd.	13.46 oz.	96 in.
902062	V02	Ninja Grey	30 yd.	13.46 oz.	72 in.
902086	V01	Pale Grey	30 yd.	13.46 oz.	96 in.
902001	P01	Pearl White	30 yd.	13.46 oz.	72 in.
902078	P01	Pearl White	30 yd.	13.46 oz.	96 in.
902076	Q17	Sand Dollar	30 yd.	13.46 oz.	72 in.
902083	Q17	Sand Dollar	30 yd.	13.46 oz.	96 in.

SheerWeave® is a registered trademark of Phifer Inc. Microban® is a registered trademark of Microban Products Company. GREENGUARD® is a registered trademark of GREENGUARD Environmental Institute.

SheerWeave® 4000 ECO

SheerWeaver 4000 ECO is PVC-free and designed with today's demanding, yet cost-conscious commercial market in mind. Its shading factor and fresh, modern look are ideal for a variety of applications. Can also be used for exterior applications. Average openness 5%.

SheerWeave is infused with Microban® antimicrobial product protection, helping to provide an additional level of cleanliness protection that won't wash or wear away for the lifetime of the fabric. Microban protection inhibits the growth of stain and odor-causing bacteria, mold and mildew and works continuously, keeping fabrics cleaner for longer. This product is GREENGUARD® and GREENGUARD® Gold certified.

FABRIC	Bio-Based Plasticizer Encapsulated Polyester Yarns
FR STANDARDS MET	California U.S. Title 19 (small scale), NFPA 701-2004 TM#1 (small scale), NFPA 101 (Class A Rating), IBC Section 903.1 (Class A Rating), BS 5867 2008 Part 2 Type B Performance, NFPA 701 TM#2 (large scale), ASTM E 84 (Class 1), CAN/ULC-S 109-03 (large and small scale) and CAN/CGSB2-4.162-M80
WARRANTY	10-Year Interior; 5-Year Exterior

ITEM #	STYLE #	COLOR	PUT UP	WEIGHT	WIDTH
902320	U59	Alabaster	30 yd.	19.2 oz.	126 in.
902294	U59	Alabaster	30 yd.	19.2 oz.	63 in.
902301	U59	Alabaster	30 yd.	19.2 oz.	84 in.
902365	U59	Alabaster	30 yd.	19.2 oz.	98 in.
902323	U64	Ash	30 yd.	19.2 oz.	126 in.
902297	U64	Ash	30 yd.	19.2 oz.	63 in.
902309	U64	Ash	30 yd.	19.2 oz.	84 in.
902362	U64	Ash	30 yd.	19.2 oz.	98 in.
902321	U58	Chalk	30 yd.	19.2 oz.	126 in.
902291	U58	Chalk	30 yd.	19.2 oz.	63 in.
902302	U58	Chalk	30 yd.	19.2 oz.	84 in.
902366	U58	Chalk	30 yd.	19.2 oz.	98 in.
902326	U65	Ebony	30 yd.	19.2 oz.	126 in.
902290	U65	Ebony	30 yd.	19.2 oz.	63 in.
902305	U65	Ebony	30 yd.	19.2 oz.	84 in.
902363	U65	Ebony	30 yd.	19.2 oz.	98 in.
902322	U62	Granite	30 yd.	19.2 oz.	126 in.
902296	U62	Granite	30 yd.	19.2 oz.	63 in.
902308	U62	Granite	30 yd.	19.2 oz.	84 in.
902360	U62	Granite	30 yd.	19.2 oz.	98 in.
902325	U61	Greystone	30 yd.	19.2 oz.	126 in.
902295	U61	Greystone	30 yd.	19.2 oz.	63 in.
902307	U61	Greystone	30 yd.	19.2 oz.	84 in.
902361	U61	Greystone	30 yd.	19.2 oz.	98 in.
902324	U60	Pebblestone	30 yd.	19.2 oz.	126 in.
902298	U60	Pebblestone	30 yd.	19.2 oz.	63 in.
902300	U60	Pebblestone	30 yd.	19.2 oz.	84 in.
902364	U60	Pebblestone	30 yd.	19.2 oz.	98 in.
902292	U63	Pewter	30 yd.	19.2 oz.	63 in.
902303	U63	Pewter	30 yd.	19.2 oz.	84 in.
902368	U63	Pewter	30 yd.	19.2 oz.	98 in.
902327	U66	Tobacco	30 yd.	19.2 oz.	126 in.
902293	U66	Tobacco	30 yd.	19.2 oz.	63 in.
902306	U66	Tobacco	30 yd.	19.2 oz.	84 in.
902367	U66	Tobacco	30 yd.	19.2 oz.	98 in.

SheerWeave® is a registered trademark of Phifer Inc. Microban® is a registered trademark of Microban Products Company. GREENGUARD® is a registered trademark of GREENGUARD Environmental Institute.

SheerWeave® 4100 ECO

SheerWeave 4100 ECO is the new PVC-free version of SheerWeave 4100. It is similar in style to SheerWeave 4000 but has a slightly more open weave to provide increased outward visibility. Can also be used for exterior applications. Average openness 10%.

SheerWeave is infused with Microban® antimicrobial product protection, helping to provide an additional level of cleanliness protection that won't wash or wear away for the lifetime of the fabric. Microban protection inhibits the growth of stain and odor-causing bacteria, mold and mildew and works continuously, keeping fabrics cleaner for longer. This product is GREENGUARD® and GREENGUARD® Gold certified.

FABRIC	Bio-Based Platicizer Encapsulated Polyester Yarns
FR STANDARDS MET	California U.S. Title 19 (small scale), NFPA 701-2004 TM#1 (small scale), NFPA 101 (Class A Rating), IBC Section 903.1 (Class A Rating), BS 5867 2008 Part 2 Type B Performance, NFPA 701 TM#2 (large scale), ASTM E 84 (Class 1), CAN/ULC-S 109-03 (large and small scale) and CAN/CGSB2-4.162-M80
WARRANTY	10-Year Interior; 5-Year Exterior

ITEM #	STYLE #	COLOR	PUT UP	WEIGHT	WIDTH
902340	U59	Alabaster	30 yd.	17.5 oz.	63 in.
902330	U59	Alabaster	30 yd.	17.5 oz.	84 in.
902312	U59	Alabaster	30 yd.	17.5 oz.	98 in.
902348	U64	Ash	30 yd.	17.5 oz.	63 in.
902338	U64	Ash	30 yd.	17.5 oz.	84 in.
902342	U58	Chalk	30 yd.	17.5 oz.	63 in.
902332	U58	Chalk	30 yd.	17.5 oz.	84 in.
902317	U58	Chalk	30 yd.	17.5 oz.	98 in.
902344	U65	Ebony	30 yd.	17.5 oz.	63 in.
902331	U65	Ebony	30 yd.	17.5 oz.	84 in.
902311	U65	Ebony	30 yd.	17.5 oz.	98 in.
902347	U62	Granite	30 yd.	17.5 oz.	63 in.
902337	U62	Granite	30 yd.	17.5 oz.	84 in.
902315	U62	Granite	30 yd.	17.5 oz.	98 in.
902345	U61	Greystone	30 yd.	17.5 oz.	63 in.
902336	U61	Greystone	30 yd.	17.5 oz.	84 in.
902314	U61	Greystone	30 yd.	17.5 oz.	98 in.
902341	U60	Pebblestone	30 yd.	17.5 oz.	63 in.
902333	U60	Pebblestone	30 yd.	17.5 oz.	84 in.
902316	U60	Pebblestone	30 yd.	17.5 oz.	98 in.
902343	U63	Pewter	30 yd.	17.5 oz.	63 in.
902334	U63	Pewter	30 yd.	17.5 oz.	84 in.
902313	U63	Pewter	30 yd.	17.5 oz.	98 in.
902346	U66	Tobacco	30 yd.	17.5 oz.	63 in.
902335	U66	Tobacco	30 yd.	17.5 oz.	84 in.
902310	U66	Tobacco	30 yd.	17.5 oz.	98 in.

SheerWeave® is a registered trademark of Phifer Inc. Microban® is a registered trademark of Microban Products Company. GREENGUARD® is a registered trademark of GREENGUARD Environmental Institute.

SheerWeave® 4400 ECO

SheerWeave 4400 ECO is the new PVC-free version of SheerWeave 4400. It's similar to SheerWeave 4000 but has a 3% openness factor to provide maximum UV blockage. It can also be used for exterior applications.

SheerWeave is infused with Microban® antimicrobial product protection, helping to provide an additional level of cleanliness protection that won't wash or wear away for the lifetime of the fabric. Microban protection inhibits the growth of stain and odor-causing bacteria, mold and mildew and works continuously, keeping fabrics cleaner for longer. This product is GREENGUARD® and GREENGUARD® Gold certified.

FABRIC	Bio-Based Platicizer Encapsulated Polyester Yarns
FR STANDARDS MET	California U.S. Title 19 (small scale), NFPA 701-2004 TM#1 (small scale), NFPA 101 (Class A Rating), IBC Section 903.1 (Class A Rating), BS 5867 2008 Part 2 Type B Performance, NFPA 701 TM#2 (large scale), ASTM E 84 (Class 1), CAN/ULC-S 109-03 (large and small scale) and CAN/CGSB2-4.162-M80
WARRANTY	10-Year Interior; 5-Year Exterior

ITEM #	STYLE #	COLOR	PUT UP	WEIGHT	WIDTH
904483	U59	Alabaster	30 yd.	20.7 oz.	126 in.
904453	U59	Alabaster	30 yd.	20.7 oz.	63 in.
904464	U59	Alabaster	30 yd.	20.7 oz.	84 in.
904476	U59	Alabaster	30 yd.	20.7 oz.	98 in.
904485	U64	Ash	30 yd.	20.7 oz.	126 in.
904458	U64	Ash	30 yd.	20.7 oz.	63 in.
904477	U64	Ash	30 yd.	20.7 oz.	98 in.
904482	U58	Chalk	30 yd.	20.7 oz.	126 in.
904450	U58	Chalk	30 yd.	20.7 oz.	63 in.
904461	U58	Chalk	30 yd.	20.7 oz.	84 in.
904472	U58	Chalk	30 yd.	20.7 oz.	98 in.
904487	U65	Ebony	30 yd.	20.7 oz.	126 in.
904454	U65	Ebony	30 yd.	20.7 oz.	63 in.
904470	U65	Ebony	30 yd.	20.7 oz.	98 in.
904480	U62	Granite	30 yd.	20.7 oz.	126 in.
904457	U62	Granite	30 yd.	20.7 oz.	63 in.
904467	U62	Granite	30 yd.	20.7 oz.	84 in.
904478	U62	Granite	30 yd.	20.7 oz.	98 in.
904484	U61	Greystone	30 yd.	20.7 oz.	126 in.
904456	U61	Greystone	30 yd.	20.7 oz.	63 in.
904466	U61	Greystone	30 yd.	20.7 oz.	84 in.
904473	U61	Greystone	30 yd.	20.7 oz.	98 in.
904486	U60	Pebblestone	30 yd.	20.7 oz.	126 in.
904451	U60	Pebblestone	30 yd.	20.7 oz.	63 in.
904462	U60	Pebblestone	30 yd.	20.7 oz.	84 in.
904471	U60	Pebblestone	30 yd.	20.7 oz.	98 in.
904452	U63	Pewter	30 yd.	20.7 oz.	63 in.
904463	U63	Pewter	30 yd.	20.7 oz.	84 in.
904474	U63	Pewter	30 yd.	20.7 oz.	98 in.
904481	U66	Tobacco	30 yd.	20.7 oz.	126 in.
904455	U66	Tobacco	30 yd.	20.7 oz.	63 in.
904465	U66	Tobacco	30 yd.	20.7 oz.	84 in.
904475	U66	Tobacco	30 yd.	20.7 oz.	98 in.

SheerWeave® is a registered trademark of Phifer Inc. Microban® is a registered trademark of Microban Products Company. GREENGUARD® is a registered trademark of GREENGUARD Environmental Institute.

SheerWeave® 4500

Using advances in polyester yarn development, Style 4500 is thinner and lighter weight, allowing for ease of fabrication. Style 4500 is a full basket weave, making it ideal for applications that require a more opaque and non-directional fabric. Can also be used in exterior roller shades. Average openness 5%.

SheerWeave is infused with Microban® antimicrobial product protection, helping to provide an additional level of cleanliness protection that won't wash or wear away for the lifetime of the fabric. Microban protection inhibits the growth of stain and odor-causing bacteria, mold and mildew and works continuously, keeping fabrics cleaner for longer. This product is GREENGUARD® and GREENGUARD® Gold certified.

FABRIC	Vinyl Encapsulated Polyester Yarns
FR STANDARDS MET	California U.S. Title 19 (small scale), NFPA 701-2004 TM#1 (small scale), NFPA 101 (Class A Rating), IBC Section 903.1 (Class A Rating), BS 5867 2008 Part 2 Type B Performance, NFPA 701 TM#2 (large scale), ASTM E 84 (Class 1) and CAN/ULC-S 109-03 (large and small scale)
WARRANTY	10-Year Interior; 5-Year Exterior

ITEM #	STYLE #	COLOR	PUT UP	WEIGHT	WIDTH
904520	V95	Cappuccino	30 yd.	14.4 oz.	63 in.
904502	V95	Cappuccino	30 yd.	14.4 oz.	98 in.
904501	P06	Chalk	30 yd.	14.4 oz.	98 in.
904522	Q59	Ecru	30 yd.	14.4 oz.	98 in.
904500	Q60	Golden Sand	30 yd.	14.4 oz.	98 in.
904521	P10	Granite	30 yd.	14.4 oz.	63 in.

SheerWeave® is a registered trademark of Phifer Inc. Microban® is a registered trademark of Microban Products Company. GREENGUARD® is a registered trademark of GREENGUARD Environmental Institute.

SheerWeave® 4550

Using advances in polyester yarn development, Style 4550 is thinner and lighter weight, allowing for ease of fabrication. Style 4550 is a full basket weave, making it ideal for applications that require a more opaque and non-directional fabric. Can also be used in exterior roller shades. Average openness 5%.

SheerWeave is infused with Microban® antimicrobial product protection, helping to provide an additional level of cleanliness protection that won't wash or wear away for the lifetime of the fabric. Microban protection inhibits the growth of stain and odor-causing bacteria, mold and mildew and works continuously, keeping fabrics cleaner for longer. This product is GREENGUARD® and GREENGUARD® Gold certified.

FABRIC	Vinyl Encapsulated Polyester Yarns
FR STANDARDS MET	California U.S. Title 19 (small scale), NFPA 701-2004 TM#1 (small scale), NFPA 101 (Class A Rating), IBC Section 903.1 (Class A Rating), BS 5867 2008 Part 2 Type B Performance, NFPA 701 TM#2 (large scale), ASTM E 84 (Class 1) and CAN/ULC-S 109-03 (large and small scale)
WARRANTY	10-Year Interior; 5-Year Exterior

ITEM #	STYLE #	COLOR	PUT UP	WEIGHT	WIDTH
904551	P65	Linen	30 yd.	12.5 oz.	98 in.

SheerWeave® is a registered trademark of Phifer Inc. Microban® is a registered trademark of Microban Products Company. GREENGUARD® is a registered trademark of GREENGUARD Environmental Institute.

SheerWeave® 4600

Using advances in polyester yarn development, Style 4600 is thinner and lighter weight, allowing for ease of fabrication. Woven in a 2x2 basketweave, these fabrics are ideal for applications where a more opaque and non-directional fabric is needed. Can also be used in exterior roller shades. Average openness 3%.

SheerWeave is infused with Microban® antimicrobial product protection, helping to provide an additional level of cleanliness protection that won't wash or wear away for the lifetime of the fabric. Microban protection inhibits the growth of stain and odor-causing bacteria, mold and mildew and works continuously, keeping fabrics cleaner for longer. This product is GREENGUARD® and GREENGUARD® Gold certified.

FABRIC	Vinyl Encapsulated Polyester Yarns
FR STANDARDS MET	California U.S. Title 19 (small scale), NFPA 701-2004 TM#1 (small scale), NFPA 101 (Class A Rating), IBC Section 903.1 (Class A Rating), BS 5867 2008 Part 2 Type B Performance, NFPA 701 TM#2 (large scale), ASTM E 84 (Class 1) and CAN/ULC-S 109-03 (large and small scale)
WARRANTY	10-Year Interior; 5-Year Exterior

ITEM #	STYLE #	COLOR	PUT UP	WEIGHT	WIDTH
904650	Q59	Ecru	30 yd.	17.4 oz.	63 in.
904602	Q59	Ecru	30 yd.	17.4 oz.	98 in.
904601	Q60	Golden Sand	30 yd.	17.4 oz.	98 in.
904604	P10	Granite	30 yd.	17.4 oz.	98 in.

SheerWeave® is a registered trademark of Phifer Inc. Microban® is a registered trademark of Microban Products Company. GREENGUARD® is a registered trademark of GREENGUARD Environmental Institute.

SheerWeave® 4650

Using thin polyester yarns and a unique twill weave, Style 4650 is easy to fabricate and offers a distinct two-sided appearance that maximizes both visibility and solar heat reduction. Suitable for exterior roller shades. Average openness 3%.

SheerWeave is infused with Microban® antimicrobial product protection, helping to provide an additional level of cleanliness protection that won't wash or wear away for the lifetime of the fabric. Microban protection inhibits the growth of stain and odor-causing bacteria, mold and mildew and works continuously, keeping fabrics cleaner for longer. This product is GREENGUARD® and GREENGUARD® Gold certified.

FABRIC	Vinyl Encapsulated Polyester Yarns
FR STANDARDS MET	California U.S. Title 19 (small scale), NFPA 701-2004 TM#1 (small scale), NFPA 101 (Class A Rating), IBC Section 903.1 (Class A Rating), BS 5867 2008 Part 2 Type B Performance, NFPA 701 TM#2 (large scale), ASTM E 84 (Class 1) and CAN/ULC-S 109-03 (large and small scale)
WARRANTY	10-Year Interior; 5-Year Exterior

ITEM #	STYLE #	COLOR	PUT UP	WEIGHT	WIDTH
904671	C47	Chestnut	30 yd.	13.3 oz.	63 in.
904670	V45	Coal	30 yd.	13.3 oz.	63 in.
904690	P10	Granite	30 yd.	13.3 oz.	98 in.
904672	P65	Linen	30 yd.	13.3 oz.	63 in.

SheerWeave® is a registered trademark of Phifer Inc. Microban® is a registered trademark of Microban Products Company. GREENGUARD® is a registered trademark of GREENGUARD Environmental Institute.



ITEM #	STYLE #	COLOR	PUT UP	WEIGHT	WIDTH
905016	Q95	Tweed/Buckeye	30 yd.	13.6 oz.	74 in.
905024	Q95	Tweed/Buckeye	30 yd.	13.6 oz.	98 in.
905023	Q94	Tweed/Oatmeal	30 yd.	13.6 oz.	98 in.
905026	Q51	Wicker/Mushroom	30 yd.	14.3 oz.	98 in.

SheerWeave® is a registered trademark of Phifer Inc. Microban® is a registered trademark of Microban Products Company. GREENGUARD® is a registered trademark of GREENGUARD Environmental Institute.

SheerWeave® 7000

SheerWeave 7000 is uniquely designed to provide total light blockage when complete room darkening is needed. With a broad range of decorator colors, the look and feel of rich cloth and a PVC-free composition, SheerWeave 7000 will enhance the beauty and function of both commercial and residential spaces. This product is GREENGUARD® and GREENGUARD® Gold certified.

FABRIC	100% Polyester (PVC-free)
FINISH	Acrylic Foam Backing
FR STANDARDS MET	California U.S. Title 19 (small scale), NFPA 701-2004 TM#1 (small scale), BS 5867 2008 Part 2 Type B Performance, CAN/ULC-S 109-03 (large and small scale), ASTM E 84 (Class 1), and CAN/CGSB2-4.162-M80
WARRANTY	5 Year Interior Only

ITEM #	STYLE #	COLOR	PUT UP	WEIGHT	WIDTH
907050	P63	Birch	30 yd.	13.41 oz.	118 in.
907001	P63	Birch	30 yd.	13.41 oz.	94 in.
907055	U67	Canvas	30 yd.	13.41 oz.	118 in.
907057	V41	Canyon	30 yd.	13.41 oz.	118 in.
907006	V41	Canyon	30 yd.	13.41 oz.	94 in.
907056	U69	Cocoa	30 yd.	13.41 oz.	118 in.
907009	Q58	Cocoa	30 yd.	13.41 oz.	94 in.
907058	V39	Graphite	30 yd.	13.41 oz.	118 in.
907004	V39	Graphite	30 yd.	13.41 oz.	94 in.
907054	Q58	Mushroom	30 yd.	13.41 oz.	118 in.
907007	Q58	Mushroom	30 yd.	13.41 oz.	94 in.
907059	V40	Onyx	30 yd.	13.41 oz.	118 in.
907005	V40	Onyx	30 yd.	13.41 oz.	94 in.
907052	P64	Sand	30 yd.	13.41 oz.	118 in.
907002	P64	Sand	30 yd.	13.41 oz.	94 in.
907053	Q57	Wheat	30 yd.	13.41 oz.	118 in.
907003	Q57	Wheat	30 yd.	13.41 oz.	94 in.
907000	P62	White	30 yd.	13.41 oz.	94 in.

SheerWeave® is a registered trademark of Phifer Inc. Microban® is a registered trademark of Microban Products Company. GREENGUARD® is a registered trademark of GREENGUARD Environmental Institute.

SheerWeave® 5000

SheerWeave Style 5000 jacquard fabrics combine rich, textured yarns with traditional patterns to create a color palette of hushed naturals and rich earth tones. Woven from vinyl coated polyester and uncoated polyester yarns, these fabrics are as durable as they are beautiful. The collection offers a range of classic options designed to suit any style of décor. Style 5000 can also be used in exterior roller shades. This product is GREENGUARD® and GREENGUARD® Gold certified.

FABRIC	Vinyl Coated Polyester And Uncoated Polyester Yarns
FR STANDARDS MET	California US Title 19 (Small Scale), NFPA 701-2004 TM#1 (Small and Large Scale), BS 5867 2008 Part 2 Type B Performance, ASTM E 84, NFPA 101 (Class A Rating), and IBC Section 903.1 (Class A Rating)
WARRANTY	10-Year Interior; 5-Year Exterior

ITEM #	STYLE #	COLOR	PUT UP	WEIGHT	WIDTH
905025	P60	Bamboo/Birch	30 yd.	14.5 oz.	98 in.
905008	Q46	Bamboo/Wheat	30 yd.	14.3 oz.	74 in.
905020	Q46	Bamboo/Wheat	30 yd.	14.5 oz.	98 in.
905010	Q48	Bark/Cedar	30 yd.	12.3 oz.	74 in.
905028	Q48	Bark/Cedar	30 yd.	12.3 oz.	98 in.
905012	Q50	Bark/Tiger Oak	30 yd.	14.3 oz.	74 in.
905022	Q50	Bark/Tiger Oak	30 yd.	14.5 oz.	98 in.
905043	U15	Crepe Granola	30 yd.	13.6 oz.	98 in.
905015	Q53	Honeycomb/Brown Sugar	30 yd.	13 oz.	74 in.
905018	R88	Jute/ Coffee	30 yd.	13.5 oz.	74 in.
905030	U11	Linen/Burlap	30 yd.	16.1 oz.	74 in.
905032	R12	Linen/Cinnamon	30 yd.	14.1 oz.	74 in.
905037	R12	Linen/Cinnamon	30 yd.	14.1 oz.	98 in.
905019	R11	Linen/Cranberry	30 yd.	14.1 oz.	74 in.
905038	R11	Linen/Cranberry	30 yd.	14.1 oz.	98 in.
905031	U12	Linen/Cream	30 yd.	16.1 oz.	74 in.
905009	Q47	Moire/Mocha	30 yd.	12.3 oz.	74 in.
905011	Q49	Rattan/Umber	30 yd.	14.3 oz.	74 in.
905021	Q49	Rattan/Umber	30 yd.	14.5 oz.	98 in.
905044	U29	Seaglass Crystal	30 yd.	14.3 oz.	74 in.
905002	U24	Seaglass Silver	30 yd.	14.3 oz.	74 in.
905040	U25	Seaglass/Copper	30 yd.	14.3 oz.	98 in.
905017	Q96	Thatch/Wheatgrass	30 yd.	13.5 oz.	74 in.

SheerWeave® 7100

When selecting light-blocking window treatments for a # of rooms within the same building, SheerWeave 7100 is an ideal choice. Similar to SheerWeave 2000, this laminated blackout fabric was designed to match other SheerWeave fabrics for a coordinated look. Made from PVC-coated fiberglass and laminated with a two-ply 100 percent PVC blackout film. SheerWeave 7100 comes in neutral color styles.

SheerWeave is infused with Microban® antimicrobial product protection, helping to provide an additional level of cleanliness protection that won't wash or wear away for the lifetime of the fabric. Microban protection inhibits the growth of stain and odor-causing bacteria, mold and mildew and works continuously, keeping fabrics cleaner for longer. This product is GREENGUARD® and GREENGUARD® Gold certified.

FABRIC	PVC-Coated Fiberglass
FINISH	Laminated with 100% 2-Ply PVC Blackout film
FR STANDARDS MET	California U.S. Title 19 (small scale), NFPA 701-2004 TM#1 (small scale), NFPA 101 (Class A Rating), IBC Section 903.1 (Class A Rating), NFPA 701 TM#2 (large scale), ASTM E 84 (Class 1), and BS 5867 2008 Part 2 Type B Performance
WARRANTY	10 Year Interior Only

ITEM #	STYLE #	COLOR	PUT UP	WEIGHT	WIDTH
907095	Q05	Bone	30 yd.	19.8 oz.	63 in.
907114	Q05	Bone	30 yd.	19.8 oz.	96 in.
907096	Q06	Bone/Platinum	30 yd.	19.8 oz.	63 in.
907113	Q06	Bone/Platinum	30 yd.	19.8 oz.	96 in.
907097	V21	Charcoal	30 yd.	19.8 oz.	63 in.
907110	V21	Charcoal	30 yd.	19.8 oz.	96 in.
907094	P02	White	30 yd.	19.8 oz.	63 in.
907106	P02	White	30 yd.	19.8 oz.	96 in.
907098	P04	White/Bone	30 yd.	19.8 oz.	63 in.
907111	P04	White/Bone	30 yd.	19.8 oz.	96 in.
907099	P05	White/Platinum	30 yd.	19.8 oz.	63 in.
907112	P05	White/Platinum	30 yd.	19.8 oz.	96 in.

SheerWeave® is a registered trademark of Phifer Inc. Microban® is a registered trademark of Microban Products Company. GREENGUARD® is a registered trademark of GREENGUARD Environmental Institute.

SheerWeave® 7500

This attractive blackout fabric is an economical option featuring a classic range of neutral colors. Suitable for roller shades, vertical blinds and panel track systems, SheerWeave 7500 is a unique PVC-free coated polyester fabric.

SheerWeave is infused with Microban® antimicrobial product protection, helping to provide an additional level of cleanliness protection that won't wash or wear away for the lifetime of the fabric. Microban protection inhibits the growth of stain and odor-causing bacteria, mold and mildew and works continuously, keeping fabrics cleaner for longer. This product is GREENGUARD® and GREENGUARD® Gold certified.

FABRIC	100% Polyester
FINISH	PVC-free Acrylic Coating
FR STANDARDS MET	California U.S. Title 19 (small scale), NFPA 701-2004 TM#1 (small scale), ASTM E 84 (Class 1), and CAN/ULC-S 109-03 (large and small scale)
WARRANTY	5 Year Interior Only

ITEM #	STYLE #	COLOR	PUT UP	WEIGHT	WIDTH
907540	R13	Ice	30 yd.	12.14 oz.	118 in.
907543	R16	Spirit	30 yd.	12.14 oz.	118 in.

SheerWeave® is a registered trademark of Phifer Incorporated. GREENGUARD® is a registered trademark of GREENGUARD Environmental Institute.

SheerWeave® BASIC 3%

SheerWeave BASIC 3% is the latest in innovative sun control fabric development. With all the benefits, certifications and technical specifications you have come to expect from SheerWeave but uniquely designed for the demanding and competitive commercial market, SheerWeave BASIC is an ideal choice for your spec-driven projects. A more robust core yarn gives SheerWeave BASIC the added durability high traffic areas and public spaces require. Suitable for all types of interior window shade applications, SheerWeave BASIC is an economical alternative to traditional solar screen fabrics.

SheerWeave is infused with Microban® antimicrobial product protection, helping to provide an additional level of cleanliness protection that won't wash or wear away for the lifetime of the fabric. Microban protection inhibits the growth of stain and odor-causing bacteria, mold and mildew and works continuously, keeping fabrics cleaner for longer. This product is GREENGUARD® and GREENGUARD® Gold certified.

FABRIC	Fiberglass
FR STANDARDS MET	California U.S. Title 19 (small scale), NFPA 701-2004 TM#1 (small scale), NFPA 101 (Class A Rating), IBC Section 903.1 (Class A Rating), BS 5867 2008 Part 2 Type B Performance, CAN/ULC-S 109-03 (large and small scale), ASTM E 84 (Class 1), NFPA 701 TM#2 (large scale) and CAN/CGSB2-4.162-M80
WARRANTY	10-Year Interior; 5-Year Exterior

ITEM #	STYLE #	COLOR	PUT UP	WEIGHT	WIDTH
906003	V21	Charcoal	30 yd.	16.4 oz.	98 in.
906000	P02	White	30 yd.	16.4 oz.	98 in.
906002	P04	White/Bone	30 yd.	16.4 oz.	98 in.

SheerWeave® is a registered trademark of Phifer Inc. Microban® is a registered trademark of Microban Products Company. GREENGUARD® is a registered trademark of GREENGUARD Environmental Institute.

SheerWeave® BASIC 5%

SheerWeave BASIC is the latest in innovative sun control fabric development. With all the benefits, certifications and technical specifications you have come to expect from SheerWeave but uniquely designed for the demanding and competitive commercial market, SheerWeave BASIC is an ideal choice for your spec-driven projects. A more robust core yarn gives SheerWeave BASIC the added durability high traffic areas and public spaces require. Suitable for all types of interior window shade applications, SheerWeave BASIC is an economical alternative to traditional solar screen fabrics.

SheerWeave is infused with Microban® antimicrobial product protection, helping to provide an additional level of cleanliness protection that won't wash or wear away for the lifetime of the fabric. Microban protection inhibits the growth of stain and odor-causing bacteria, mold and mildew and works continuously, keeping fabrics cleaner for longer. This product is GREENGUARD® and GREENGUARD® Gold certified.

FABRIC	Fiberglass
FR STANDARDS MET	California U.S. Title 19 (small scale), NFPA 701-2004 TM#1 (small scale), NFPA 101 (Class A Rating), IBC Section 903.1 (Class A Rating), BS 5867 2008 Part 2 Type B Performance, CAN/ULC-S 109-03 (large and small scale), ASTM E 84 (Class 1), NFPA 701 TM#2 (large scale) and CAN/CGSB2-4.162-M80
WARRANTY	10-Year Interior; 5-Year Exterior

ITEM #	STYLE #	COLOR	PUT UP	WEIGHT	WIDTH
906103	V21	Charcoal	30 yd.	14.1 oz.	98 in.
906104	V22	Charcoal/Grey	30 yd.	14.1 oz.	98 in.
906100	P02	White	30 yd.	14.1 oz.	98 in.
906101	P04	White/Bone	30 yd.	14.1 oz.	98 in.
906102	P05	White/Platinum	30 yd.	14.1 oz.	98 in.

SheerWeave® is a registered trademark of Phifer Inc. Microban® is a registered trademark of Microban Products Company. GREENGUARD® is a registered trademark of GREENGUARD Environmental Institute.

SheerWeave® Infinity 2

SheerWeave Infinity 2 is an eco-friendly full basket weave. Emulating the look and engineering of standard SheerWeave fabrics, Infinity core yarn and coating is PVC-free, lead-free and 100% recyclable.

SheerWeave is infused with Microban® antimicrobial product protection, helping to provide an additional level of cleanliness protection that won't wash or wear away for the lifetime of the fabric. Microban protection inhibits the growth of stain and odor-causing bacteria, mold and mildew and works continuously, keeping fabrics cleaner for longer. This product is GREENGUARD® and GREENGUARD® Gold certified.

FABRIC	100% Recycled Content
FR STANDARDS MET	ASTM E-84 (Class I), NFPA 701-2004 TM#1 (small scale), NFPA 101 (Class A Rating), CAN/ULC-S 109-03 Large and CAN/CGSB2-4.162-M80
WARRANTY	5-Year Interior Only

ITEM #	STYLE #	COLOR	PUT UP	WEIGHT	WIDTH
902350	PG1	Cotton	30 yd.	14.63 oz.	98 in.

SheerWeave® is a registered trademark of Phifer Inc. Microban® is a registered trademark of Microban Products Company. GREENGUARD® is a registered trademark of GREENGUARD Environmental Institute.



SunScreen®

SunScreen reduces solar heat gain in the summer and interior heat loss in the winter, absorbing and dissipating up to 70% of the sun's heat and glare before it reaches the window, while also performing as an insect screen.

SunScreen is infused with Microban® antimicrobial product protection, helping to provide an additional level of cleanliness protection that won't wash or wear away for the lifetime of the screen. Microban protection inhibits the growth of stain and odor-causing bacteria, mold and mildew and works continuously, keeping screens cleaner for longer. This product is GREENGUARD® and GREENGUARD® Gold certified.

FABRIC	Vinyl Encapsulated Fiberglass Yarns
FR STANDARDS MET	NFPA 101 (Class B Rating) and IBC Section 903.1 (Class A Rating)
WARRANTY	10-Year Exterior

ITEM #	COLOR	PUT UP	WEIGHT	WIDTH
902022	Charcoal	100 ft.	8.5 oz.	48 in.
901982	Charcoal	100 ft.	8.5 oz.	84 in.
901985	Silver Gray	100 ft.	8.5 oz.	84 in.

SunScreen® is a registered trademark of Phifer Incorporated. Microban® is a registered trademark of Microban Products Company. GREENGUARD® is a registered trademark of GREENGUARD Environmental Institute.

Super Solar Screening

Super Solar Screening offers the ultimate in shading protection by blocking up to 90% of the sun's heat and glare before it penetrates windows and doors. This fabric is installed like regular insect screening and improves daytime privacy while offering excellent outward visibility. Ideal for extremely hot windows, doors and porches, Super Solar Screening helps save energy and keeps carpets and draperies from fading.

Super Solar Screening is infused with Microban® antimicrobial product protection, helping to provide an additional level of cleanliness protection that won't wash or wear away for the lifetime of the screen. Microban protection inhibits the growth of stain and odor-causing bacteria, mold and mildew and works continuously, keeping screens cleaner for longer. The product is GREENGUARD® certified.

FABRIC		Vinyl Encapsulated Fiberglass Yarns		
ITEM #	COLOR	PUT UP	WEIGHT	WIDTH
902775	Charcoal	100 ft.	10.4 oz.	36 in.
902778	Charcoal	100 ft.	10.4 oz.	48 in.
902780	Charcoal	100 ft.	10.4 oz.	84 in.

Microban® is a registered trademark of Microban Products Company. GREENGUARD® is a registered trademark of GREENGUARD Environmental Institute.

SunTex® 80

SunTex is a unique woven mesh that can block up to 80% of the sun's hot rays before they enter your windows. Mildew and fade resistant, SunTex is ideal for use as a shading fabric on windows, doors and porches and offers good ventilation. This heavy-duty fabric is made of strong vinyl-coated polyester and is resistant to pet damage. Average openness 20%.

SunTex is infused with Microban® antimicrobial product protection, helping to provide an additional level of cleanliness protection that won't wash or wear away for the lifetime of the screen. Microban protection inhibits the growth of stain and odor-causing bacteria, mold and mildew and works continuously, keeping screens cleaner for longer. This product is GREENGUARD® and GREENGUARD® Gold certified.

FABRIC		Vinyl Encapsulated Polyester Yarns		
FR STANDARDS MET	California Technical Bulletin 117 Section E (CS-191-53) and IBC Section 903.1 (Class A Rating)			
WARRANTY	10-Year Exterior			

ITEM #	COLOR	PUT UP	WEIGHT	WIDTH
902091	Black	100 ft.	13.5 oz.	48 in.
902003	Black	100 ft.	13.5 oz.	60 in.
902006	Black	100 ft.	13.5 oz.	72 in.
902097	Black	100 ft.	13.5 oz.	96 in.
902007	Brown	100 ft.	13.5 oz.	60 in.
902016	Brown	100 ft.	13.5 oz.	72 in.
902017	Gray	100 ft.	13.5 oz.	72 in.
902092	Stucco	100 ft.	13.5 oz.	48 in.
902037	Stucco	100 ft.	13.5 oz.	60 in.
902015	Stucco	100 ft.	13.5 oz.	72 in.
902095	Stucco	100 ft.	13.5 oz.	96 in.

SunTex® is a registered trademark of Phifer Incorporated. GREENGUARD® is a registered trademark of GREENGUARD Environmental Institute. Microban® is a registered trademark of Microban Products Company.

SunTex® 90

SunTex is a unique woven mesh that can block up to 90% of the sun's hot rays before they enter your windows. Mildew and fade resistant, SunTex is ideal for use as a shading fabric on windows, doors and porches and offers good ventilation. This heavy-duty fabric is made of strong vinyl-coated polyester and is resistant to pet damage. Average openness 10%.

SunTex is infused with Microban® antimicrobial product protection, helping to provide an additional level of cleanliness protection that won't wash or wear away for the lifetime of the screen. Microban protection inhibits the growth of stain and odor-causing bacteria, mold and mildew and works continuously, keeping screens cleaner for longer. This product is GREENGUARD® and GREENGUARD® Gold certified.

FABRIC		Vinyl Encapsulated Polyester Yarns		
FR STANDARDS MET	California Technical Bulletin 117 Section E (CS-191-53) and IBC Section 903.1 (Class A Rating)			
WARRANTY	10-Year Exterior			

ITEM #	COLOR	PUT UP	WEIGHT	WIDTH
903007	Beige	100 ft.	17.2 oz.	120 in.
902038	Beige	100 ft.	17.2 oz.	72 in.
902059	Beige	100 ft.	17.2 oz.	96 in.
903013	Black	100 ft.	17.2 oz.	120 in.
902034	Black	100 ft.	17.2 oz.	48 in.
902031	Black	100 ft.	17.2 oz.	60 in.
903000	Black	100 ft.	17.2 oz.	72 in.
902069	Brown	100 ft.	17.2 oz.	96 in.
902096	Gray	100 ft.	17.2 oz.	72 in.
902063	Gray	100 ft.	17.2 oz.	96 in.
903014	Stucco	100 ft.	17.2 oz.	120 in.
902033	Stucco	100 ft.	17.2 oz.	48 in.
902065	Stucco	100 ft.	17.2 oz.	72 in.
902068	Stucco	100 ft.	17.2 oz.	96 in.

SunTex® is a registered trademark of Phifer Incorporated. GREENGUARD® is a registered trademark of GREENGUARD Environmental Institute. Microban® is a registered trademark of Microban Products Company.

Textilene® 90

A durable and tough synthetic fabric made of PVC coated polyester. Designed to reduce heat transfer through windows, this fabric also reduces the glare and harmful rays from the sun. Flame resistant and fade resistant, it is a durable alternative for insect screen. Screen blocks up to 90% of the sun's rays.

Textilene is GREENGUARD® Gold and REACH certified, RoHS compliant, Phthalate and Lead (Pb) free and complies with California Proposition 65 (with the exception of having to list FR chemicals where applicable). Printable/Digital imaging capable.

FABRIC	PVC Coated Polyester
FR STANDARDS MET	California State Fire Marshal Title 19, NFPA 701
WARRANTY	10-Year

ITEM #	STYLE #	COLOR	PUT UP	WIDTH
903267	T18DCS084	Beige	33 yd.	120 in.
903223	T18DCS077	Beige	33 Yards	48 in.
903257	T18DCS081	Beige	33 yd.	96 in.
903269	T18DCS082	Black	33 yd.	120 in.
903271	T18DCS079	Black	33 Yards	96 in.
903268	T18DCS083	Brown	33 yd.	120 in.
903272	T18DCS080	Brown	33 Yards	96 in.
903266	T18BCT015	Desert Sand	33 yd.	120 in.
903224	T18BCT011	Desert Sand	33 Yards	48 in.
903259	T18BCT014	Desert Sand	33 yd.	96 in.
903270	T18DCS015	Grey	33 Yards	96 in.
903273	T18DCS086	White	33 Yards	120 in.
903258	T18DCS085	White	33 yd.	96 in.

Textilene® is a registered trademark of Twitchell Corporation. GREENGUARD® is a registered trademark of GREENGUARD Environmental Institute.

Textilene® 95

A durable and tough synthetic fabric made of PVC coated polyester. Designed to reduce heat transfer through windows, this fabric also reduces the glare and harmful rays from the sun. Flame resistant and fade resistant, it is a durable alternative for insect screen. Screen blocks up to 95% of the sun's rays.

Textilene is GREENGUARD® Gold and REACH certified, RoHS compliant, Phthalate and Lead (Pb) free and complies with California Proposition 65 (with the exception of having to list FR chemicals where applicable). Printable/Digital imaging capable.

FABRIC	PVC Coated Polyester
FR STANDARDS MET	California State Fire Marshal Title 19, NFPA 701
WARRANTY	10-Year

ITEM #	STYLE #	COLOR	PUT UP	WEIGHT	WIDTH
903298	T18A2T005	Almond Brown	28 yd.	17.3 oz.	120 in.
903291	T18A25001	Galaxy Black	28 yd.	17.3 oz.	120 in.
903294	T18A25003	Graphite	28 yd.	17.3 oz.	120 in.
903295	T18A2T001	Mushroom	28 yd.	17.3 oz.	120 in.
903293	T18A2T004	Pewter	28 yd.	17.3 oz.	120 in.
903299	T18A2S004	Pure White	28 yd.	17.3 oz.	120 in.
903296	T18A2T002	Putty	28 yd.	17.3 oz.	120 in.
903292	T18A2A002	Quartz	28 yd.	17.3 oz.	120 in.
903290	T18A2T003	Tobacco Leaf	28 yd.	17.3 oz.	120 in.

Textilene® is a registered trademark of Twitchell Corporation. GREENGUARD® is a registered trademark of GREENGUARD Environmental Institute.



Serge Ferrari Soltis® 86

Soltis 86 is an ideal vinyl mesh used for exterior windows, commercial building facades, greenhouses, rooftops, or retractable awnings. It also helps regulate the thermal effect of the sun, and it preserves privacy and comfort without obstructing the view.

Serge Ferrari's exclusive and patented Précontraint® process enables Soltis 86 excellent dimensional stability for large expanses. Soltis 86 delivers exceptional durability under a variety of intense wind and weather conditions.

105-inch width rolls of Soltis 86 cannot ship UPS.

FABRIC	High-Tenacity Polyester
FINISH	Vinyl
FR STANDARDS MET	California State Fire Marshal Title 19; NFPA 701; ASTM E-84
WARRANTY	5-Year

ITEM #	STYLE #	COLOR	PUT UP	WEIGHT	WIDTH
879248	86-2048	Aluminum	54 yd.	11 oz.	69 in.
879268	86-2068	Aluminum/Anthracite (Aluminum/Charcoal)	54 yd.	11 oz.	69 in.
879586	86-2046-105	Aluminum/Oat (Aluminum/Ivory)	43 yd.	11 oz.	105 in.
879246	86-2046	Aluminum/Oat (Aluminum/Ivory)	54 yd.	11 oz.	69 in.
879614	86-2047-105	Anthracite (Charcoal)	43 yd.	11 oz.	105 in.
879247	86-2047	Anthracite (Charcoal)	54 yd.	11 oz.	69 in.
879233	86-50333	Bamboo	54 yd.	11 oz.	69 in.
879588	86-2045-105	Beaten Metal (Dark Aluminum)	43 yd.	11 oz.	105 in.
879245	86-2045	Beaten Metal (Dark Aluminum)	54 yd.	11 oz.	69 in.

ITEM #	STYLE #	COLOR	PUT UP	WEIGHT	WIDTH
879620	86-2053-105	Black	43 yd.	11 oz.	105 in.
879253	86-2053	Black	54 yd.	11 oz.	69 in.
879671	86-2171-105	Boulder	43 yd.	11 oz.	105 in.
879271	86-2171	Boulder	54 yd.	11 oz.	69 in.
879610	86-2043-105	Bronze (Olive Brown)	43 yd.	11 oz.	105 in.
879243	86-2043	Bronze (Olive Brown)	54 yd.	11 oz.	69 in.
879266	86-2166	Buttercup	54 yd.	11 oz.	69 in.
879262	86-50261	Caramel	54 yd.	11 oz.	69 in.
879275	86-2175	Champagne	54 yd.	11 oz.	69 in.
879288	86-2148	Cocoa	54 yd.	11 oz.	69 in.
879267	86-2167	Concrete	54 yd.	11 oz.	69 in.
879264	86-50264	Dark Teal	54 yd.	11 oz.	69 in.
879263	86-50271	Intense Turquoise	54 yd.	11 oz.	69 in.
879261	86-2161	Midnight Blue	54 yd.	11 oz.	69 in.
879158	86-2158	Moss Green	54 yd.	11 oz.	69 in.
879260	86-50260	Muscat	54 yd.	11 oz.	69 in.
879142	86-50342	Navy	54 yd.	11 oz.	69 in.
879204	86-8204	Orange	54 yd.	11 oz.	69 in.
879590	86-2012-105	Pepper (Putty)	43 yd.	11 oz.	105 in.
879212	86-2012	Pepper (Putty)	54 yd.	11 oz.	69 in.
879236	86-50336	Plum	54 yd.	11 oz.	69 in.
879255	86-8255	Red	54 yd.	11 oz.	69 in.
879635	86-2135-105	Sandy Beige	43 yd.	11 oz.	105 in.
879285	86-2135	Sandy Beige	54 yd.	11 oz.	69 in.
879584	86-2044-105	White	43 yd.	11 oz.	105 in.
879244	86-2044	White	54 yd.	11 oz.	69 in.

Soltis® and Précontraint® are registered trademarks of The Serge Ferrari Group.



Serge Ferrari Soltis® 92

Soltis 92 is an ideal vinyl mesh used for exterior windows, commercial building facades, greenhouses, rooftops, or retractable awnings. It also helps regulate the thermal effect of the sun, and it preserves privacy and comfort without obstructing the view.

Serge Ferrari's exclusive and patented Précontraint® process enables Soltis 92 excellent dimensional stability for large expanses. Soltis 92 delivers exceptional durability under a variety of intense wind and weather conditions.

105-inch width rolls of Soltis 92 cannot ship UPS.

FABRIC	High-Tenacity Polyester
FINISH	Vinyl
FR STANDARDS MET	California State Fire Marshal Title 19; NFPA 701; ASTM E-84
WARRANTY	5-Year

ITEM #	STYLE #	COLOR	PUT UP	WEIGHT	WIDTH
879348	92-2048	Aluminum	54 yd.	12 oz.	69 in.
879374	92-2074	Aluminum/ Medium Grey (Metal/Gray)	54 yd.	12 oz.	69 in.
879398	92-2048	Aluminum/Aluminum	43 yd.	12 oz.	105 in.
879368	92-2068	Aluminum/Anthracite (Aluminum/Charcoal)	54 yd.	12 oz.	69 in.
879396	92-2046	Aluminum/Oat (Ivory)	43 yd.	12 oz.	105 in.
879399	92-2051	Aluminum/White	43 yd.	12 oz.	105 in.
878157	92-2157	Aniseed	54 yd.	12 oz.	69 in.
879397	92-2047	Anthracite (Charcoal)	43 yd.	12 oz.	105 in.
879347	92-2047	Anthracite (Charcoal)	54 yd.	12 oz.	69 in.
878333	92-50333	Bamboo	54 yd.	12 oz.	69 in.
879345	92-2045	Beaten Metal (Dark Aluminum)	54 yd.	12 oz.	69 in.
879400	92-2053	Black	43 yd.	12 oz.	105 in.
879353	92-2053	Black	54 yd.	12 oz.	69 in.
879471	92-2171	Boulder	43 yd.	12 oz.	105 in.

ITEM #	STYLE #	COLOR	PUT UP	WEIGHT	WIDTH
878171	92-2171	Boulder	54 yd.	12 oz.	69 in.
879393	92-2043	Bronze (Olive Brown)	43 yd.	12 oz.	105 in.
879343	92-2043	Bronze (Olive Brown)	54 yd.	12 oz.	69 in.
878166	92-2166	Buttercup	54 yd.	12 oz.	69 in.
878261	92-50261	Caramel	54 yd.	12 oz.	69 in.
878172	92-2172	Carrot	54 yd.	12 oz.	69 in.
878176	92-2175	Champagne	54 yd.	12 oz.	69 in.
878272	92-50272	Cloud	54 yd.	12 oz.	69 in.
878148	92-2148	Cocoa	54 yd.	12 oz.	69 in.
879467	92-2167	Concrete	43 yd.	12 oz.	105 in.
878167	92-2167	Concrete	54 yd.	12 oz.	69 in.
878274	92-50274	Copper	54 yd.	12 oz.	69 in.
878267	92-50267	Cotto	54 yd.	12 oz.	69 in.
878273	92-50273	Gold	54 yd.	12 oz.	69 in.
879339	92-2039	Green Tree (Forest Green)	54 yd.	12 oz.	69 in.
878268	92-50268	Grenadine	54 yd.	12 oz.	69 in.
878266	92-50266	Havana Brown	54 yd.	12 oz.	69 in.
878269	92-50269	Hawaii	54 yd.	12 oz.	69 in.
879465	92-50265	Hemp	43 yd.	12 oz.	105 in.
878265	92-50265	Hemp	54 yd.	12 oz.	69 in.
878271	92-50271	Intense Turquoise	54 yd.	12 oz.	69 in.
878160	92-2160	Lagoon	54 yd.	12 oz.	69 in.
878161	92-2161	Midnight Blue	54 yd.	12 oz.	69 in.
878158	92-2158	Moss Green	54 yd.	12 oz.	69 in.
878260	92-50260	Muscat	54 yd.	12 oz.	69 in.
878204	92-8204	Orange	54 yd.	12 oz.	69 in.
879312	92-2012	Pepper (Putty)	54 yd.	12 oz.	69 in.
878336	92-50336	Plum	54 yd.	12 oz.	69 in.
878255	92-8255	Red	54 yd.	12 oz.	69 in.
879435	92-2135	Sandy Beige	43 yd.	12 oz.	105 in.
878135	92-2135	Sandy Beige	54 yd.	12 oz.	69 in.
878270	92-50270	Thistle	54 yd.	12 oz.	69 in.
878163	92-2163	Turtle Dove	54 yd.	12 oz.	69 in.
878152	92-2152	Velvet Red	54 yd.	12 oz.	69 in.
878164	92-2164	Violet Parma	54 yd.	12 oz.	69 in.
878137	92-2137	Walnut Stain	54 yd.	12 oz.	69 in.
879394	92-2044	White	43 yd.	12 oz.	105 in.
879344	92-2044	White	54 yd.	12 oz.	69 in.

Soltis® and Précontraint® are registered trademarks of The Serge Ferrari Group.

Serge Ferrari Soltis® 92 Blackout

Soltis B92 provides a black out layer that prevents any detectable transmission of visible light and UV rays. It does not require any kind of reinforcement and the thin, flat properties of the fabric suit small sized windows. Ideal for interior or exterior block out blinds. GREENGUARD® certified.

FABRIC	Woven Polyester Base Cloth, Weldable PVC Coating
FINISH	Acrylic Lacquer Both Sides
FR STANDARDS MET	NFPA-701
WARRANTY	5-Year

ITEM #	STYLE #	COLOR	PUT UP	WEIGHT	WIDTH
879846	B92-N-1046	Aluminum/Aluminum	43 yd.	19.17 oz.	67 in.
879845	B92-N-1045	Beaten Metal/Aluminum	43 yd.	19.17 oz.	67 in.
879848	B92-N-2171	Boulder/Aluminum	43 yd.	19.17 oz.	67 in.
879843	B92-N-1043	Bronze (Brown)/Aluminum	43 yd.	19.17 oz.	67 in.
879847	B92-N-2135	Sand Beige/Aluminum	43 yd.	19.17 oz.	67 in.
879844	B92-N-1044	White/Aluminum	43 yd.	19.17 oz.	67 in.

Soltis® is a registered trademark of The Serge Ferrari Group. GREENGUARD® is a registered trademark of GREENGUARD Environmental Institute.

Serge Ferrari Soltis® B702 Black Out

Soltis B702 provides a black out layer that prevents any detectable transmission of visible light and UV rays. It does not require any kind of reinforcement and the thin, flat properties of the fabric suit small sized windows. Ideal for interior or exterior block out blinds. GREENGUARD® certified.

FABRIC	Woven Polyester Base Cloth, Weldable PVC Coating
FINISH	Acrylic Lacquer Both Sides
FR STANDARDS MET	California State Fire Marshal Title 19; NFPA 701; ASTM E-84
WARRANTY	5-Year

ITEM #	STYLE #	COLOR	PUT UP	WIDTH
879840	B702-455-71	Black/White	43 yd.	71 in.

Soltis® is a registered trademark of The Serge Ferrari Group. GREENGUARD® is a registered trademark of GREENGUARD Environmental Institute.



Sunbrella® Contour

Sunbrella Contour is a rich, textured shade fabric delivering the ultimate in UV protection, color uniformity and long-lasting performance. It features a unique, patent-pending construction that emphasizes its rich colors. Offering optimal light transmission, Sunbrella Contour filters light while still allowing water to pass through.

Sunbrella Contour is more supple and less abrasive than other shade fabrics, offering easier fabrication and installation. Creases and wrinkles that may appear during fabrication will quickly smooth out after the installation.

Ideal for many applications where the aesthetic of a textured fabric is desired:

- Shade sails
- Fixed frame shade structures and engineered shade structures
- Windscreens
- Umbrella canopies and cabanas
- Canopies for casual furniture such as chaises, daybeds and loungers
- Marine applications such as cockpit awnings, biminis and fender covers Sunbrella

Contour is GREENGUARD® certified.

FABRIC	Sunbrella® Acrylic / HDPE
FR STANDARDS MET	California Technical Bulletin 117-2013 Class 1
WARRANTY	10-Year

ITEM #	STYLE #	COLOR	PUT UP	WEIGHT	WIDTH
884649	2649-0000	Apex Aztec	28 yd.	11.5 oz.	120 in.
884647	2647-0000	Apex Beige	28 yd.	11.5 oz.	120 in.
884644	2644-0000	Apex Cadet	28 yd.	11.5 oz.	120 in.
884643	2643-0000	Apex Charcoal	28 yd.	11.5 oz.	120 in.
884650	2650-0000	Apex Concord	28 yd.	11.5 oz.	120 in.
884646	2646-0000	Apex Crimson	28 yd.	11.5 oz.	120 in.
884640	2640-0000	Apex Forest	28 yd.	11.5 oz.	120 in.
884654	2654-0000	Apex Indigo	28 yd.	11.5 oz.	120 in.
884642	2642-0000	Apex Pacific	28 yd.	11.5 oz.	120 in.
884648	2648-0000	Apex Pebble	28 yd.	11.5 oz.	120 in.
884645	2645-0000	Apex Salt	28 yd.	11.5 oz.	120 in.
884651	2651-0000	Apex Sunflower	28 yd.	11.5 oz.	120 in.
884653	2653-0000	Apex Sunset	28 yd.	11.5 oz.	120 in.
884652	2652-0000	Apex Terracotta	28 yd.	11.5 oz.	120 in.
884641	2641-0000	Apex Wren	28 yd.	11.5 oz.	120 in.

Sunbrella® is a registered trademark of Glen Raven, Inc. GREENGUARD® is a registered trademark of GREENGUARD Environmental Institute.



Architec 400®

Architec 400 is an extremely strong UV stabilized knitted shade cloth that has been designed for large commercial tension membrane structures and shade sails. It is a High Density Polyethylene fabric with an excellent weight to strength ratio, has very good tensile strength, and is extremely resistant to tearing. This fabric also incorporates the latest in ultraviolet stabilizers that provide improved color consistency and colorfastness. This fabric is lead and phthalate free.

Architec 400 cannot ship UPS due to its 150-inch roll width.

FABRIC	High Density Polyethylene (HDPE)
FR STANDARDS MET	ASTM E-84 Class 1 or A rating
WARRANTY	12-Year Against UV Degradation

ITEM #	COLOR	PUT UP	WEIGHT	WIDTH
865140	Aquamarine	164 ft.	12 oz.	150 in.
865142	Black	164 ft.	12 oz.	150 in.
865143	Cappuccino	164 ft.	12 oz.	150 in.
865152	Golden Yellow	164 ft.	12 oz.	150 in.
865144	Grape	164 ft.	12 oz.	150 in.
865146	Lime	164 ft.	12 oz.	150 in.
865147	Midnight Green	164 ft.	12 oz.	150 in.
865148	Navy Blue	164 ft.	12 oz.	150 in.
865149	Orange	164 ft.	12 oz.	150 in.
865150	Porcelain	164 ft.	12 oz.	150 in.
865151	Slate Gray	164 ft.	12 oz.	150 in.
865153	Turquoise	164 ft.	12 oz.	150 in.

Architec 400® is a registered trademark of Polyfab USA.

Comtex®

A superior fire rated knitted HDPE shade fabric designed for large tension membrane structures and architectural shade sails. Recommended for larger commercial installations with unsupported spans of up to 100 feet. This fabric is lead and phthalate free.

FABRIC	High Density Polyethylene (HDPE)
FR STANDARDS MET	NFPA 701; ASTM E84 Class A
WARRANTY	10-Year Against UV Degradation

ITEM #	COLOR	PUT UP	WEIGHT	WIDTH
865203	Aquamarine	100 ft. (center folded)	10 oz.	150 in.
865234	Aussie Green	100 ft. (center folded)	10 oz.	150 in.
865221	Black	100 ft. (center folded)	10 oz.	150 in.
865219	Bronze	100 ft. (center folded)	10 oz.	150 in.
865231	Cafe Noir	100 ft. (center folded)	10 oz.	150 in.
865229	Cappuccino	100 ft. (center folded)	10 oz.	150 in.
865237	Golden Yellow	100 ft. (center folded)	10 oz.	150 in.
865201	Midnight Green	100 ft. (center folded)	10 oz.	150 in.
865205	Navy Blue	100 ft. (center folded)	10 oz.	150 in.
865215	Porcelain	100 ft. (center folded)	10 oz.	150 in.
865227	Red	100 ft. (center folded)	10 oz.	150 in.
865209	Rust	100 ft. (center folded)	10 oz.	150 in.
865211	Sage	100 ft. (center folded)	10 oz.	150 in.
865207	Sandstone	100 ft. (center folded)	10 oz.	150 in.
865225	Silver	100 ft. (center folded)	10 oz.	150 in.
865213	Slate Gray	100 ft. (center folded)	10 oz.	150 in.
865233	White	100 ft. (center folded)	10 oz.	150 in.

Comtex® is a registered trademark of Polyfab USA LLC.



Polytex®

Polytex is manufactured from High Density Polyethylene (HDPE), using a monofilament and tape construction. The fabric is produced by knitting the monofilament and tape together utilizing "Raschel Knit" (lock stitch) construction to ensure that the fabric will not tear or fray if cut or pierced by sharp objects. Polytex has been designed for shade structures and architectural shade sails, providing UVA and UVB protection greater than 95%. Its high strength to weight ratio, UV performance and fire rating make it the ideal choice for small scale projects where shade and protection are desired. This fabric is lead and phthalate free.

FABRIC	High Density Polyethylene (HDPE)
FR STANDARDS MET	NFPA 701; ASTM E84, Class A Building Material
WARRANTY	10-Year Against UV Degradation

ITEM #	COLOR	PUT UP	WEIGHT	WIDTH
865103	Aquamarine	100 ft. (center folded)	7 oz.	150 in.
865134	Aussie Green	100 ft. (center folded)	7 oz.	150 in.
865121	Black	100 ft. (center folded)	7 oz.	150 in.
865119	Bronze	100 ft. (center folded)	7 oz.	150 in.
865131	Cafe Noir	100 ft. (center folded)	7 oz.	150 in.
865129	Cappuccino	100 ft. (center folded)	7 oz.	150 in.
865137	Golden Yellow	100 ft. (center folded)	7 oz.	150 in.
865135	Grape	100 ft. (center folded)	7 oz.	150 in.
865136	Lime	100 ft. (center folded)	7 oz.	150 in.
865101	Midnight Green	100 ft. (center folded)	7 oz.	150 in.
865105	Navy Blue	100 ft. (center folded)	7 oz.	150 in.
865115	Porcelain	100 ft. (center folded)	7 oz.	150 in.
865127	Red	100 ft. (center folded)	7 oz.	150 in.
865109	Rust	100 ft. (center folded)	7 oz.	150 in.
865111	Sage	100 ft. (center folded)	7 oz.	150 in.
865107	Sandstone	100 ft. (center folded)	7 oz.	150 in.
865125	Silver	100 ft. (center folded)	7 oz.	150 in.
865113	Slate Gray	100 ft. (center folded)	7 oz.	150 in.
865133	White	100 ft. (center folded)	7 oz.	150 in.

Polytex® is a registered trademark of Polyfab USA LLC.

Commercial 95® 340

An ultraviolet-stabilized HPDE monofilament and tape knitted fabric, Commercial 95 340 was developed specifically for use in fabric structures, awnings and shade covers. Strong and stable, it offers an ideal shade solution for commercial and architectural applications such as school playgrounds, sporting facilities, parking structures, outdoor cafes, car dealerships, outdoor pool areas and more.

Designed to "breathe," Commercial 95 340 allows cooling breezes to flow through, significantly reducing temperatures beneath. The fabric's knitted, lock-stitch construction prevents tearing and fraying when cut. Colors remain vivid for years. GREENGUARD®, GREENGUARD® Select and OEKO-TEX® Certified. 100% lead and phthalate free.

FABRIC	UV Stabilized HDPE Mono/Tape Construction
FINISH	Heat Treated
FR STANDARDS MET	ASTM E84, Class A (Class I-25 or under Flame Spread)
WARRANTY	10-Year Against UV Degradation

ITEM #	STYLE #	COLOR	PUT UP	WEIGHT	WIDTH
865020	444938	Aquatic Blue	131 ft. (center folded)	10 oz.	118 in.
865021	444945	Black	131 ft. (center folded)	10 oz.	118 in.
865027	481254	Brown	131 ft. (center folded)	10 oz.	118 in.
865022	444952	Brunswick Green	131 ft. (center folded)	10 oz.	118 in.
865033	455255	Cayenne	131 ft. (center folded)	10 oz.	118 in.
865035	465360	Cedar	131 ft. (center folded)	10 oz.	118 in.
865023	444976	Cherry Red	131 ft. (center folded)	10 oz.	118 in.
865034	444990	Deep Ochre Red	131 ft. (center folded)	10 oz.	118 in.
865024	444983	Desert Sand	131 ft. (center folded)	10 oz.	118 in.
865039	455262	Gun Metal	131 ft. (center folded)	10 oz.	118 in.
865025	445003	Natural	131 ft. (center folded)	10 oz.	118 in.
865026	445010	Navy Blue	131 ft. (center folded)	10 oz.	118 in.
865028	445027	Rivergum Green	131 ft. (center folded)	10 oz.	118 in.
865029	445034	Sky Blue	131 ft. (center folded)	10 oz.	118 in.
865030	445041	Steel Grey	131 ft. (center folded)	10 oz.	118 in.
865031	445065	Turquoise	131 ft. (center folded)	10 oz.	118 in.
865032	445072	Yellow	131 ft. (center folded)	10 oz.	118 in.

Commercial 95® is a registered trademark of Gale Pacific Limited. GREENGUARD® is a registered trademark of GREENGUARD Environmental Institute. OEKO-TEX™ is a registered trademark of the OEKO-TEX Association.

Commercial FR 300 (SaFRshade™)

Commercial FR 300, SaFRshade™, is specifically designed to be the safest choice in architectural shade fabric. Made from UV stabilized HDPE monofilament and tape yarns. Commercial FR 300 has a specialized lock stitch knit for more air movement and better channeling of cool breezes. It is constructed to block up to 95% of harmful UV rays. Commercial FR 300 is recyclable, tear resistant and will not crack, rot or fade and has a 10 year manufacturer's warranty against UV degradation. It is 100% lead and phthalate free. GREENGUARD® and OEKO-TEX® Certified.

FABRIC	High Density Polyethylene (HDPE)
FR STANDARDS MET	NFPA 701; ASTM E84, Class A; CSFM Section 13115
WARRANTY	10-Year Against UV Degradation

ITEM #	STYLE #	COLOR	PUT UP	WEIGHT	WIDTH
865063	456795	Beige	35 yd. (center folded)	8.79 oz.	118 in.
865060	456719	Cobalt Blue	35 yd. (center folded)	8.79 oz.	118 in.
865065	456818	Ivory	35 yd. (center folded)	8.79 oz.	118 in.
865067	456887	Olive	35 yd. (center folded)	8.79 oz.	118 in.
865064	456924	Slate Grey	35 yd. (center folded)	8.79 oz.	118 in.
865062	456771	Terra Cotta	35 yd. (center folded)	8.79 oz.	118 in.

SaFRshade™ is a trademark of Gale Pacific Limited. GREENGUARD® is a registered trademark of GREENGUARD Environmental Institute. OEKO-TEX® is a registered trademark of the OEKO-TEX Association.

Vivitex® Poly Oxford White

The Vivitex collection of printable fabrics from Glen Raven is specifically designed for use on most solvent, eco solvent, UV inkjet and latex printers, and can be used for a variety of indoor and outdoor sign and banner applications. Vivitex fabrics have excellent depth of color and detail, with a matte finish that produces a softer look. The inkjet receptive layer provides a white base to improve color management while creating a barrier which prevents ink bleed through.

This oxford weave polyester fabric has a white inkjet receptive top coat that is suitable for indoor/outdoor applications such as banners, patio/market umbrellas, P.O.P. displays, table drops, backdrops, sales promotions, revolving banners, and promotional bags. Available in full rolls only.

FABRIC	Oxford Weave Polyester
FINISH	White Inkjet Receptive Top Coat
WARRANTY	None

ITEM #	STYLE #	COLOR	PUT UP	WEIGHT	WIDTH
908487	1664-0000	White	25 yd.	8 oz.	54 in.
908491	1663-0000	White	50 yd.	8 oz.	60 in.

Vivitex® is a registered trademark of Glen Raven, Inc.

Vivitex® Sunbrella® Inkjet White

The Vivitex collection of printable fabrics from Glen Raven is specifically designed for use on most solvent, eco solvent, UV inkjet and latex printers, and can be used for a variety of indoor and outdoor sign and banner applications. Vivitex fabrics have excellent depth of color and detail, with a matte finish that produces a softer look. The inkjet receptive layer provides a white base to improve color management while creating a barrier which prevents ink bleed through.

Sunbrella Inkjet White is Sunbrella awning and marine fabric with a white inkjet receptive top coat suitable for indoor and long-term outdoor applications such as banners (including street poles), awnings, car covers, boat covers, pennants, patio/market umbrellas, P.O.P. displays, wall coverings, table drops, back drops, sales promotions, revolving banners, and promotional bags. Available in full rolls only.

FABRIC	100% Sunbrella Acrylic
FINISH	White Inkjet Receptive Top Coat
WARRANTY	3-Year

ITEM #	STYLE #	COLOR	PUT UP	WEIGHT	WIDTH
908495	1666-0000	White	25 yd.	10 oz.	54 in.
908499	1665-0000	White	50 yd.	10 oz.	60 in.

Vivitex® is a registered trademark of Glen Raven, Inc.



SGS Thermal Digital Print Film

SGS Thermal Digital Print Film is a flexible urethane film which can be digitally printed and applied to Sunbrella® or other Glen Raven fabrics using the Sunbrella Graphics System to produce high quality, durable graphics for banners, umbrellas, covers and many other textile applications where flexibility of the fabric and film is needed. The adhesive is thermal activated, is dry to the touch at low temperatures and will remain dry to the touch once cooled. The adhesive can reduce the application time by 75% compared to other pressure sensitive films. The film can also be used unprinted for white lettering or graphics where printing is not required but the flexibility/durability is important. SGS Thermal Digital Print Film is suitable for use in most solvent, eco-solvent, and UV printers. Sold in full rolls only.

ITEM #	STYLE #	PUT UP	WIDTH
901676	1676-0000	25.153 yd.	30 in.
901678	1678-0000	25.153 yd.	60 in.

Sunbrella® is a registered trademark of Glen Raven, Inc.

SGS Thermal Lettering Film

Unlike SGS Thermal Digital Print Film, SGS Thermal Lettering Film is only intended for lettering and is not printable.

The film's adhesive layer is on the face side (top) of the film, meaning that it will have to be "reverse-plotted", weeded and then applied to the fabric without the need of transfer tape – like standard SGS film.

Sold in full rolls only.

ITEM #	STYLE #	COLOR	PUT UP	WIDTH
901677	VIX1026	Black	25.153 yd.	30 in.

Flag – Nylon

ITEM #	COLOR	DENIER	PUT UP	WEIGHT	WIDTH
724800	White	200	100 yd., 300 yd. cartons	2.92 oz.	59 in.

Amerglo™

High quality polyester used for reflecting light. Ideal for items requiring nighttime visibility or reflectivity for added safety.

FABRIC	100% Polyester
FINISH	Reflective Finish

ITEM #	STYLE #	COLOR	PUT UP	WEIGHT	WIDTH
999330	530	Aluminum	100 yd.	8 oz.	60 in.

Amerglo™ is a trademark of MarChem CFI.

Evolution®

Evolution is an advanced generation fabric, ideal for a wide range of protective applications including automobile covers, sports and equipment bags, marine covers, and tarpaulins. With four-layer construction, it is strong and durable, yet lightweight and drapable. Evolution offers excellent UV resistance and water repellency. Its breathable barrier allows air to circulate and keeps moisture and contaminants out. The fabric is washable, quick drying, mold and mildew resistant, and won't stretch or shrink. All styles have a gray backside.

FABRIC	Polypropylene/Polyethylene
---------------	----------------------------

ITEM #	COLOR	PUT UP	WEIGHT	WIDTH
720312	Gray	300 yd.	4.8 oz.	55 in.

Evolution® is a registered trademark of Kimberly-Clark World Wide, Inc.

Block-It® Matrix

Block-It Matrix is a storage/mooring cover fabric that is water repellent (not waterproof), breathable, UV, mildew and rot resistant. Matrix is not recommended for trailered (over-the-road) applications.

FABRIC	100% Polypropylene
---------------	--------------------

ITEM #	COLOR	PUT UP	WEIGHT	WIDTH
720308	Gray	370 Yards	3.8 oz.	55 in.

Block-It® is a registered trademark of Kimberly-Clark World Wide, Inc.

Noah® Barrier Fabric

A technologically advanced car cover fabric. Its proprietary bicomponent technology provides the highest level of softness and strength and blocks water, while providing for breathability. Primarily for outdoor use, Noah serves as a complete barrier to most dust, dirt and other environmental hazards and pollutants, and guards against surface scratches. Easily compactible. Industrial tumble front-load machine or hand washable.

FABRIC	Polyethylene and Polypropylene
WARRANTY	None

ITEM #	COLOR	PUT UP	WEIGHT	WIDTH
720310	Gray	375 yd.	4.7 oz.	55 in.

Noah® is a registered trademark of Kimberly-Clark World Wide, Inc.

Sunforger® Car Cover Flannel

Suntan color for boat and automobile covers where flannel is needed to prevent marring of finish. Water repellent and mildew resistant. NOT BOAT SHRUNK. Recommended for dust cover applications. Not intended for trailerable covers.

FABRIC	Canton Flannel
FINISH	Mineral-Dyed

ITEM #	COLOR	PUT UP	WEIGHT	WIDTH
710002	Tan	80 yd.	8 oz.	55 in.

Sunforger® is a registered trademark of M.F. & H Textiles.



Softouch™

Softouch is a combination of an acrylic coated woven polyester and a soft non-woven backing of 100% polyester. Fabricating professionals can now provide their customers with a material that has the strength, dimensional stability and water and abrasion resistance, along with a scratch resistant softness that comes from the non-woven backing. Now fabricators, covering sensitive gelcoats, critical painted surfaces and delicate objects, can provide worry-free protection. Resists surface growth of mildew, but should not be folded and stored while wet.

FABRIC	Acrylic Coated Woven Polyester
FINISH	Backing: Soft Non-Woven Backing of 100% Polyester
WARRANTY	3-Year

ITEM #	STYLE #	COLOR	PUT UP	WEIGHT	WIDTH
774517	999	Birch	50 yd.	11 oz.	60 in.
774502	949	Black	50 yd.	11 oz.	60 in.
774514	996	Burgundy	50 yd.	11 oz.	60 in.
774513	994	Caribbean Blue	50 yd.	11 oz.	60 in.
774519	992	Charcoal	50 yd.	11 oz.	60 in.
774507	988	Forest Green	50 yd.	11 oz.	60 in.
774509	998	Harbor Blue	50 yd.	11 oz.	60 in.
774503	980	Royal Blue	50 yd.	11 oz.	60 in.
774508	989	Silver Gray	50 yd.	11 oz.	60 in.
774500	908	Taupe	50 yd.	11 oz.	60 in.
774506	987	White	50 yd.	11 oz.	60 in.

Softouch™ is a trademark of Marlen Textiles.

Coverlight® CSM Coated Nylon

Coverlight CSM coated nylon features all the advantages of Neoprene coating, but with exceptional abrasion resistance. One of the most versatile cover fabrics. Withstands deterioration by weather, ozone, sunlight, heat and moderately corrosive chemicals. This fabric offers excellent service at high temperatures. More resistant to high temperatures (up to 225°F) and oxidizing agents than Neoprene or vinyl.

CSM Coated Nylon can be sewn or cemented to provide airtight and watertight seams. CSM Coated Nylon cannot be heat or R.F. welded.

Suggested Uses: Lifeboat covers, steam fumigation covers, truck tarpaulins.

FABRIC	Nylon
FINISH	CSM (Chlorosulfanated Polyethylene)
WARRANTY	None

ITEM #	STYLE #	COLOR	PUT UP	WEIGHT	WIDTH
965295	16209	Black	100 yd.	16 oz.	60 in.
965296	16242	Black	75 yd.	35 oz.	60 in.
965290	15954	Green	100 yd.	17 oz.	60 in.
965291	15955	Red	100 yd.	17 oz.	60 in.
965294	16147	Red	100 yd.	22 oz.	60 in.
965293	15957	White	100 yd.	17 oz.	60 in.

Coverlight® is a registered trademark of Trelleborg.

Coverlight® Neoprene® Coated Nylon

Coverlight Neoprene coated nylon is a versatile general purpose material that provides good resilience and tensile strength. A popular choice for truck tarps, machine covers, and aircraft wing covers. This fabric is resistant to water, mildew and many solvents and petroleum based products. Available with a textured or a dusted surface. The dusted surface requires buffing before applying cement, but is less expensive and lends itself to a better surface for slipping the material on and off a truck, aircraft or similar type equipment. Material cannot be R.F. welded.

Performs well at temperatures up to 225°F

FABRIC	Nylon
FINISH	Neoprene
WARRANTY	None

ITEM #	STYLE #	DESCRIPTION	COLOR	PUT UP	WEIGHT	WIDTH
960012	18412	Dusted	Aluminum Gray/ Aluminum Gray	100 yd.	16 oz.	60 in.
960014	18335		Black	50 yd.	40 oz.	60 in.
960009	18404	Textured	Black/Aluminum Gray	100 yd.	16 oz.	60 in.
960011	18411	Dusted	Black/Black	100 yd.	16 oz.	60 in.
960008	18403	Textured	Black/Black	100 yd.	16 oz.	60 in.

Coverlight® is a registered trademark of Trelleborg. Neoprene® is a registered trademark of E.I. du Pont de Nemours and Company.

Dock Seal

Outstanding abrasion resistance, tear strength, and weatherability give these products a competitive advantage in the marketplace. Dock Seal is suitable for dock seal and heavy-duty tarp applications.

FABRIC	Polyester
FINISH	Vinyl Coated

ITEM #	STYLE #	DESCRIPTION	COLOR	PUT UP	WEIGHT	WIDTH
978293	35-415		Black	50 yd.	35 oz.	60 in.
978294	35-445	High Tear	Black	50 yd.	35 oz.	60 in.

Tonneau-Tex® SP

A wide width for tonneau covers and protective applications requiring a minimum of seams. High tear and tensile strength. Weather, abrasion and rot resistance. Excellent cleanability and dimensional stability.

FABRIC	100% Polyester Base
FINISH	Crush Embossed, Vinyl Coated

ITEM #	COLOR	PUT UP	WEIGHT	WIDTH
734515	Black	25 yd.	18 oz.	78 in.

Tonneau-Tex® is a registered trademark of Bruin Plastics Co.

Trivantage® GVC18

Trivantage GVC18 is an ideal choice for situations demanding a strong, durable tarp fabric.

Trivantage GVC18 resists rips, tears, abrasions and punctures. Performing well for all kinds of fitted, flat and special-duty tarps, this strong, economical fabric features an exceptionally soft hand that allows for ease of fabrication. It stays tough and can be easily handled at very low temperatures.

FABRIC	Vinyl Coated Polyester				
ITEM #	COLOR	PUT UP	WEIGHT	WIDTH	
960200	Black	100 yd.	18 oz.	61 in.	
960201	Blue	100 yd.	18 oz.	61 in.	
960210	Brown	100 yd.	18 oz.	61 in.	
960209	Burgundy	100 yd.	18 oz.	61 in.	
960207	Gray	100 yd.	18 oz.	61 in.	
960204	Green	100 yd.	18 oz.	61 in.	
960206	Orange	100 yd.	18 oz.	61 in.	
960202	Red	100 yd.	18 oz.	61 in.	
960208	Tan	100 yd.	18 oz.	61 in.	
960203	White	100 yd.	18 oz.	61 in.	
960205	Yellow	100 yd.	18 oz.	61 in.	

Trivantage® is a registered trademark of Glen Raven, Inc.

Tru-Tarp Plus

For use in applications that require strength, such as truck and equipment covers, tarps, container covers, pond liners, air structures, tennis court backdrops and swimming pool covers.

FABRIC	PVC Coated Polyester				
FINISH	Matte				

ITEM #	STYLE #	COLOR	PUT UP	WEIGHT	WIDTH
967230	999	Black	110 yd.	18 oz.	61 in.
967231	899	Blue	110 yd.	18 oz.	61 in.
967238	399	Gray	110 yd.	18 oz.	61 in.
967233	733	Green	110 yd.	18 oz.	61 in.
967237	448	Red	110 yd.	18 oz.	61 in.
967240	199	White	110 yd.	18 oz.	61 in.
967235	699	Yellow	110 yd.	18 oz.	61 in.

Utility Trash Tarp Fabric

This multi-colored mesh is ideally suited for trash truck covers and tarpaulins where rain or moisture protection is not required. Used to secure truckload contents against littering of roadways from fallout or blowoff. This material may be sewn together or bonded, and is abrasion and UV resistant.

FABRIC	Vinyl Encapsulated Woven Polyester, Open Mesh				
ITEM #	COLOR	FABRIC COUNT	PUT UP	WEIGHT	WIDTH
997098	Multi-Color	11 x 11	100 yd.	9 oz.	96 in.

Phifertex® Recreational Mesh

Ideal for jump pit applications.

Phifertex is infused with Microban® antimicrobial product protection, helping to provide an additional level of cleanliness protection that won't wash or wear away for the lifetime of the fabric. Microban protection inhibits the growth of stain and odor-causing bacteria, mold and mildew and works continuously, keeping fabrics cleaner for longer. This product is GREENGUARD® and GREENGUARD® Gold certified.

FABRIC	Vinyl Encapsulated Polyester Yarns
FR STANDARDS MET	California Technical Bulletin 117
WARRANTY	3-Year

ITEM #	STYLE #	COLOR	FABRIC COUNT	PUT UP	WEIGHT	WIDTH
997322	M96	Christmas Red	13 x 12	60 yd.	10.3 oz.	72 in.
997350	G00	Royal Blue	13 x 12	60 yd.	10.3 oz.	72 in.

Phifertex® is a registered trademark of Phifer Incorporated. Microban® is a registered trademark of Microban Products Company. GREENGUARD® is a registered trademark of GREENGUARD Environmental Institute.

Polyester Utility Mesh

This medium weight fabric offers an excellent balance of strength and degree of openness. The main application is mesh truck covers.

FABRIC	Polyester
FINISH	Vinyl Encapsulated

ITEM #	COLOR	FABRIC COUNT	PUT UP	WEIGHT	WIDTH
997099	Black	11 x 11	100 yd.	11.5 oz.	72 in.
997077	Black	11 x 11	100 yd.	11.5 oz.	96 in.

Phifertex® General Purpose

Designed for use as a pool fence/barrier mesh.

Phifertex is infused with Microban® antimicrobial product protection, helping to provide an additional level of cleanliness protection that won't wash or wear away for the lifetime of the fabric. Microban protection inhibits the growth of stain and odor-causing bacteria, mold and mildew and works continuously, keeping fabrics cleaner for longer. This product is GREENGUARD® and GREENGUARD® Gold certified.

FABRIC	Vinyl Encapsulated Polyester Yarns
FR STANDARDS MET	California Technical Bulletin 117, Section E
WARRANTY	3-Year

ITEM #	STYLE #	COLOR	PUT UP	WEIGHT	WIDTH
997081	X04	Black	100 yd.	8.3 oz.	48 in.

Phifertex® is a registered trademark of Phifer Inc. Microban® is a registered trademark of Microban Products Company. GREENGUARD® is a registered trademark of GREENGUARD Environmental Institute.

VCP

Premium vinyl coated polyester fabric for over-the-road covers.

FABRIC		Vinyl Coated Polyester				
ITEM #	STYLE #	COLOR	PUT UP	WEIGHT	WIDTH	
967004	G14468	Black	110 yd.	14 oz.	61 in.	
967104	G16468	Black	110 yd.	16 oz.	61 in.	
967204	G18468	Black	110 yd.	18 oz.	61 in.	
967304	G22415	Black	110 yd.	22 oz.	61 in.	
967210	G18468	Burgundy	110 yd.	18 oz.	61 in.	
967209	G18468	Cocoa Brown	110 yd.	18 oz.	61 in.	
967006	G14468	Gray	110 yd.	14 oz.	61 in.	
967106	G16468	Gray	110 yd.	16 oz.	61 in.	
967206	G18468	Gray	110 yd.	18 oz.	61 in.	
967306	G22415	Gray	110 yd.	22 oz.	61 in.	
967003	G14468	Green	110 yd.	14 oz.	61 in.	
967203	G18468	Green	110 yd.	18 oz.	61 in.	
967303	G22415	Green	110 yd.	22 oz.	61 in.	
967207	G18468	Orange	110 yd.	18 oz.	61 in.	
967307	G22415	Orange	110 yd.	22 oz.	61 in.	
967100	G16468	Red	110 yd.	16 oz.	61 in.	
967200	G18468	Red	110 yd.	18 oz.	61 in.	
967300	G22415	Red	110 yd.	22 oz.	61 in.	
967002	G14468	Royal Blue	110 yd.	14 oz.	61 in.	
967102	G16468	Royal Blue	110 yd.	16 oz.	61 in.	
967202	G18468	Royal Blue	110 yd.	18 oz.	61 in.	
967302	G22415	Royal Blue	110 yd.	22 oz.	61 in.	
967211	G18468	Tan	110 yd.	18 oz.	61 in.	
967001	G14468	White	110 yd.	14 oz.	61 in.	
967201	G18468	White	110 yd.	18 oz.	61 in.	
967301	G22415	White	110 yd.	22 oz.	61 in.	
967005	G14468	Yellow	110 yd.	14 oz.	61 in.	
967105	G16468	Yellow	110 yd.	16 oz.	61 in.	
967205	G18468	Yellow	110 yd.	18 oz.	61 in.	
967305	G22415	Yellow	110 yd.	22 oz.	61 in.	

VCP Asphalt Tarps

Extremely strong and durable. Highly water resistant. Rated to -40°F.

FABRIC	Polyester				
FINISH	Vinyl Coated				
ITEM #	STYLE #	COLOR	PUT UP	WEIGHT	WIDTH
968021	G16330 902	Black	110 yd.	16 oz.	61 in.

Energy Shield™

This reflective, laminated fabric is ideal for insulating industrial curtains, and drop ceilings. It is also used for thermal barriers, reflective spa cover liners, soft-sided coolers, airplane windshield covers, reflective tarpaulins, pizza bags, and many more energy-saving applications.

FABRIC	Vinyl Laminated Polyester			
FINISH	Taffeta Embossing			
ITEM #	STYLE #	PUT UP	WEIGHT	WIDTH
975399	200	100 yd.	10 oz.	54 in.
975398	100	50 yd.	18 oz.	54 in.

Energy Shield™ is a trademark of Bruin Plastics Company, Inc.

Fyrguard™ Fire and Water-Resistant Cover Duck

and Single-Filled Ounce Ducks are treated to meet the many uses where fire resistance is of primary importance. The treatment penetrates the fabric and does not allow it to support flame. Sold in full rolls only.

FABRIC	Cotton Ounce Duck			
FR STANDARDS MET	CPAI-84			
WARRANTY	None			
ITEM #	COLOR	PUT UP	WEIGHT	WIDTH
766154	Olive Drab	100 yd.	12 oz.	48 in.

Fyrguard™ is a trademark of Glen Raven, Inc.

Skipper Water-Resistant Cover Duck

High-count, single-filled ounce duck, treated with the most dependable water-and mildew-resistant compounds. Ideal for tarps and covers. Sold in full rolls only.

FABRIC	Cotton Ounce Duck			
ITEM #	COLOR	PUT UP	WEIGHT	WIDTH
763654	Olive Drab	100 yd.	10 oz.	36 in.
764154	Olive Drab	100 yd.	12 oz.	48 in.
763614	Olive Drab	100 yd.	14.9 oz.	36 in.
764115	Olive Drab	100 yd.	14.9 oz.	48 in.

Herculite® Translucent – Flame Retardant

Laminated fabrics that are used in a variety of applications including construction enclosures, agricultural curtains, and divider curtains.

FABRIC	Vinyl Laminated Polyester			
FR STANDARDS MET	ASTM D6413			
ITEM #	STYLE #	PUT UP	WEIGHT	WIDTH
973030	T13	75 yd.	13 oz.	62 in.

Herculite® is a registered trademark of Herculite Products Inc.

Herculite® No. 80M

A heavy duty laminated fabric that is used in a variety of applications including stationary tarpaulins, sandblast screens, divider curtains, lifeboat covers and cargo covers. Fabric that meets government specification is available by special order.

FABRIC	Vinyl Laminated Polyester				
FR STANDARDS MET	ASTM D-6413				
ITEM #	STYLE #	COLOR	PUT UP	WEIGHT	WIDTH
973127	80M	Black	50 yd.	18 oz.	61 in.
973123	80M	Gray	50 yd.	18 oz.	61 in.
973122	80M	Navy	50 yd.	18 oz.	61 in.
973125	80M	Olive Drab	50 yd.	18 oz.	61 in.
973120	80M	Red	50 yd.	18 oz.	61 in.
973124	80M	White	50 yd.	18 oz.	61 in.
973126	80M	Yellow	50 yd.	18 oz.	61 in.

Herculite® is a registered trademark of Herculite Products Inc.

Herculite® No. 90

A heavy duty, shrink resistant laminated fabric that is used in a variety of applications including cargo covers, gym floor covers, heavy-duty upholstery, portable shelters, stationary tarpaulins and tonneau covers.

FABRIC	Vinyl Laminated Polyester				
FR STANDARDS MET	ASTM D-6413				
ITEM #	STYLE #	COLOR	PUT UP	WEIGHT	WIDTH
973142	90	Black	50 yd.	18 oz.	61 in.
973147	90	Fawn	50 yd.	18 oz.	61 in.
973143	90	Green	50 yd.	18 oz.	61 in.
973140	90	Grey	50 yd.	18 oz.	61 in.
973146	90	Red	50 yd.	18 oz.	61 in.
973145	90	Royal Blue	50 yd.	18 oz.	61 in.
973141	90	White	50 yd.	18 oz.	61 in.
973144	90	Yellow	50 yd.	18 oz.	61 in.

Herculite® is a registered trademark of Herculite Products Inc.

Lam-A-Lite™ Style C13604

This vinyl laminated polyester provides an economically priced option in general-purpose fabrics. It is mildew resistant. Not recommended for over the road tarp applications.

Suggested End Uses: wall pads, equipment covers, cushions and curtains.

FABRIC	Vinyl Laminated Polyester
FR STANDARDS MET	California State Fire Marshal; NFPA 701, Test Method 2

ITEM #	COLOR	PUT UP	WEIGHT	WIDTH
975122	Black	100 yd.	13 oz.	61 in.
975126	Blue	100 yd.	13 oz.	61 in.
975125	Gray	100 yd.	13 oz.	61 in.
975120	Green	100 yd.	13 oz.	61 in.
975123	Red	100 yd.	13 oz.	61 in.
975127	Tan	100 yd.	13 oz.	61 in.
975124	White	100 yd.	13 oz.	61 in.
975121	Yellow	100 yd.	13 oz.	61 in.

Lam-A-Lite™ is a trademark of Glen Raven, Inc.

Lam-A-Lite™ Style C10641

This vinyl laminated polyester provides an economically priced option in general-purpose fabrics. It is mildew resistant. Not recommended for over the road tarp applications.

Suggested End Uses: disposable emergency tarps, dust covers and curtains.

FABRIC	Vinyl Laminated Polyester
FR STANDARDS MET	California State Fire Marshal; NFPA 701, Test Method 2

ITEM #	COLOR	PUT UP	WEIGHT	WIDTH
975002	Black	100 yd.	10 oz.	61 in.
975006	Blue	100 yd.	10 oz.	61 in.
975005	Gray	100 yd.	10 oz.	61 in.
975003	Red	100 yd.	10 oz.	61 in.
975004	White	100 yd.	10 oz.	61 in.
975001	Yellow	100 yd.	10 oz.	61 in.

Lam-A-Lite™ is a trademark of Glen Raven, Inc.

Nico-Fab® Tarp Fabric

A low cost, first quality polypropylene tarp fabric. This material is highly ultraviolet resistant due to the amount of carbon black used. Suitable for mesh truck tarps.

FABRIC	Polypropylene				
ITEM #	STYLE #	COLOR	PUT UP	WEIGHT	WIDTH
902885	25109	Black	100 yd.	4.5 oz.	143 in.
902888	20409	Black	100 yd.	6.2 oz.	96 in.

Nico-Fab® is a registered trademark of Ten Cate Nicolon.

Poly-Mesh L60611

Lightweight, yet incredibly strong, Poly-Mesh is a durable fabric ideal for a variety of applications including pool covers, sail bags, boat covers, shade cloth and truck covers.

FABRIC	1000 Denier Weft Inserted Warp Knit Polyester				
FINISH	Vinyl Coated, Glossy				

ITEM #	STYLE #	COLOR	PUT UP	WEIGHT	WIDTH
910078	2410WL	Black	75 yd.	5.6 oz.	61 in.
910072	2406WL	White	80 yd.	5.6 oz.	61 in.

Shelter-Rite® Poly-R Scrim

A mesh fabric exhibiting superior resistance to ultraviolet degradation. A significant feature is the maintenance of strength for added years of product service.

Suggested Uses: Trash truck covers, tennis court dividers, wind screens, gravel and sand truck tarps, canal erosion liners, paddle tennis curtains, pool covers.

FABRIC	Vinyl Coated Polyester, Open Mesh				
WARRANTY	None				

ITEM #	COLOR	COLOR #	PUT UP	WEIGHT	WIDTH
950707	Black	DC-7	100 yd.	7 oz.	60 in.
950704	Gray	DC-4	100 yd.	7 oz.	60 in.
950724	Green	DC-24	100 yd.	7 oz.	60 in.
950702	Red	DC-2	100 yd.	7 oz.	60 in.
950746	Royal Blue	DC-46	100 yd.	7 oz.	60 in.
950706	White	DC-6	100 yd.	7 oz.	60 in.
950742	Yellow	DC-42	100 yd.	7 oz.	60 in.

Shelter-Rite® is a registered trademark of the Seaman Corporation.

Shelter-Rite® Tarp Fabric Style 2118

Designed for high performance and flexibility. Shelter-Rite fabrics are highly resistant to tears and abrasion.

Suggested Uses: Truck tarps, marine canopies, reefer ducts, modular fitted protection covers, pool covers, agricultural and industrial seating upholstery.

FABRIC	Vinyl Coated Nylon
---------------	--------------------

ITEM #	STYLE #	COLOR	COLOR #	PUT UP	WEIGHT	WIDTH
951850	2118	Black	DC-7	110 yd.	18 oz.	61 in.

Shelter-Rite® is a registered trademark of the Seaman Corporation.

Shelter-Rite® Tarp Fabric Style 3022

Designed for high performance and flexibility. Shelter-Rite fabrics are highly resistant to tears and abrasion.

Suggested Uses: Tough applications where high tear strength, high tensile strength, high adhesion and exceptional weather resistance are of prime importance.

FABRIC	Vinyl Coated Nylon
---------------	--------------------

ITEM #	STYLE #	COLOR	COLOR #	PUT UP	WEIGHT	WIDTH
952207	3022	Black	DC-7	100 yd.	22 oz.	61 in.

Shelter-Rite® is a registered trademark of the Seaman Corporation.

Arabian™ Dyed Army Duck

Solid vat-dyed colors for curtains, draperies, cushions, pennants and bags. Water-repellent. Continuous exposure to sunlight will cause fading.

Some commercial shade variance can be expected from dye lot to dye lot on all piece-dyed cotton goods.

FABRIC	Cotton Army Duck
FINISH	Water Repellent

ITEM #	STYLE #	COLOR	PUT UP	WEIGHT	WIDTH
736303	3	Black	100 yd.	10.10 oz.	60 in.
736301	1	Bleach White	100 yd.	10.10 oz.	60 in.
736312	12	Regatta Blue	100 yd.	10.10 oz.	60 in.

Chair Duck

Commercial water-repellent finish on cotton # duck. For chairs, bags, or products where a heavier duck is needed. Continuous exposure to sunlight will cause fading.

FABRIC	Cotton # Duck
FINISH	Water Repellent

ITEM #	STYLE #	COLOR	PUT UP	WEIGHT	WIDTH
738250	#8	Black	50 yd.	18 oz.	58 in.
738259	#8	Brite Red	75 yd.	18 oz.	58 in.
738255	#8	Olive Drab	50 yd.	18 oz.	58 in.

Double-Filled Pre-Shrunk Bleached Duck

For aisle cloths, drop cloths, filter cloths, dust covers, bags, banners, and numerous other specialty uses.

FABRIC	Cotton
FINISH	Natural/Bleached

ITEM #	FABRIC COUNT	PUT UP	WEIGHT	WIDTH
700006	84 x 28	300 yd.	7 oz.	36 in.

Midwest Brand Wide – # Duck

Suggested Uses: Heavy bags, roofing and floor covering (No. 8 or No. 10), laundry and harvester machine aprons, unprimed artist canvas (No. 12).

FABRIC		Cotton Duck		
FINISH		None (Greige)		
ITEM #	STYLE #	PUT UP	WEIGHT	WIDTH
632120	#10	100 yd.	14.5 oz.	120 in.
632036	#10	100 yd.	14.5 oz.	36 in.
632048	#10	100 yd.	14.5 oz.	48 in.
632060	#10	100 yd.	14.5 oz.	60 in.
632072	#10	100 yd.	14.5 oz.	72 in.
632320	#12	50 yd.	11.5 oz.	120 in.
632324	#12	50 yd.	11.5 oz.	144 in.
632236	#12	100 yd.	11.5 oz.	36 in.
632248	#12	100 yd.	11.5 oz.	48 in.
632260	#12	100 yd.	11.5 oz.	60 in.
632272	#12	100 yd.	11.5 oz.	72 in.
632284	#12	100 yd.	11.5 oz.	84 in.
631026	#2/0	100 yd.	32 oz.	26 in.
631448	#4	100 yd.	24 oz.	48 in.
631460	#4	100 yd.	24 oz.	60 in.
631636	#6	100 yd.	20 oz.	36 in.
631660	#6	100 yd.	20 oz.	60 in.
631836	#8	100 yd.	18 oz.	36 in.
631848	#8	100 yd.	18 oz.	48 in.
631860	#8	100 yd.	18 oz.	60 in.
631872	#8	100 yd.	18 oz.	72 in.

Sateen Duck

For dust covers, and large vacuum bags.

FABRIC		Cotton Duck		
ITEM #	PUT UP	WEIGHT	WIDTH	
640011	250 yd.	8.2 oz.	58 in.	

Single-Filled Enameling Duck

For pipe wrappers, artist cloth, dust covers, luggage lining, canvas shoes, sneakers and many other uses.

FABRIC		Cotton Duck		
ITEM #	COLOR	PUT UP	WEIGHT	WIDTH
636007	Natural	100 yd.	7 oz.	72 in.

Single-Filled Ounce Duck

A flat-weave duck with single yarns in warp and filling. Suitable for drop cloths, bags and other specialty items.

FABRIC		Cotton Duck		
ITEM #	COLOR	PUT UP	WEIGHT	WIDTH
616026	Natural	100 yd.	10 oz.	36 in.
616060	Natural	100 yd.	10 oz.	48 in.
616063	Natural	100 yd.	10 oz.	60 in.
616065	Natural	100 yd.	10 oz.	72 in.
616036	Natural	100 yd.	12 oz.	36 in.
616070	Natural	100 yd.	12 oz.	48 in.
616048	Natural	100 yd.	14.9 oz.	36 in.
616080	Natural	100 yd.	14.9 oz.	48 in.

Single-Filled Ounce Duck – A-Grade

FABRIC		Cotton		
ITEM #	COLOR	PUT UP	WEIGHT	WIDTH
600137	Natural	100 yd.	10 oz.	60 in.

U.S. Army Duck Natural

A plain-weave, firmly woven fabric made of long-staple, clean white cotton with high count, plied warp and filling yarn construction (two or more strands twisted together).

FABRIC		Cotton Duck		
ITEM #	COLOR	PUT UP	WEIGHT	WIDTH
618024	Natural/White	100 yd.	12.98 oz.	37 in.

Canton Flannel Natural – Untreated

A clean, high count twill is used to produce this fabric with nap on one side. Ideal for furniture and appliance pads and covers. Not water repellent.

FABRIC		Cotton Twill, 65% Polyester/35% Cotton		
FINISH		Napped, one side		
ITEM #	STYLE #	PUT UP	WEIGHT	WIDTH
656022	910D	300 yd.	10 oz.	37 in.
656012	912D	300 yd.	12 oz.	37 in.
656021	908D	300 yd.	8 oz.	37 in.
656070	908	250 yd.	8 oz.	71 in.



BetterVue™

Phifer's BetterVue insect screening for windows, doors and porches is an excellent visibility insect screen designed to maximize outward view.

Woven from small, refined yarns that improve the screen's openness, BetterVue makes visibility sharper and more brilliant. It's like a "high definition" insect screen for windows, doors, and screened porches. With BetterVue, customers see the clear and vibrant view, not the screen.

BetterVue has excellent visibility from inside and better curb appeal when viewing windows from the street. It features excellent insect protection due to 30% smaller openings than standard screen. An excellent product for coastal regions, BetterVue is available in black and has improved light transmittance and improved airflow due to increased openness.

BetterVue is infused with Microban® antimicrobial product protection, helping to provide an additional level of cleanliness protection that won't wash or wear away for the lifetime of the screen. Microban protection inhibits the growth of stain and odor-causing bacteria, mold and mildew and works continuously, keeping screens cleaner for longer. This product is GREENGUARD® and GREENGUARD® Gold certified.

FABRIC		Fiberglass				
ITEM #	COLOR	FABRIC COUNT	PUT UP	WEIGHT	WIDTH	
902740	Black	20 x 20	100 ft.	2.5 oz.	24 in.	
902742	Black	20 x 20	100 ft.	2.5 oz.	30 in.	
902744	Black	20 x 20	100 ft.	2.5 oz.	36 in.	
902746	Black	20 x 20	100 ft.	2.5 oz.	48 in.	
902748	Black	20 x 20	100 ft.	2.5 oz.	60 in.	
902750	Black	20 x 20	100 ft.	2.5 oz.	72 in.	
902752	Black	20 x 20	100 ft.	2.5 oz.	84 in.	
902754	Black	20 x 20	100 ft.	2.5 oz.	96 in.	

BetterVue™ is a trademark of Phifer Inc. GREENGUARD® is a registered trademark of GREENGUARD Environmental Institute. Microban® is a registered trademark of Microban Products Company.

No-See-Um Netting

This netting's tight construction prevents even the smallest bugs from getting into outdoor enclosures.

FABRIC		Polyester		
ITEM #	COLOR	PUT UP	WIDTH	
902835	Gray	100 yd.	72 in.	

Phifer® Fiberglass Screening

A mesh screening of woven fiberglass. Dimensionally stable – does not shrink or stretch. Will not corrode. Unaffected by salt air, smoke and fumes. Excellent impact resistance. Will not support combustion. Easily fabricated for windows and doors. Not recommended for swimming pool covers because of the effects of chlorine on the fabric.

FABRIC		Vinyl Coated Fiberglass				
FINISH		PVC over Fiberglass				
FR STANDARDS MET		FL-L.S.-125B				

ITEM #	STYLE #	COLOR	FABRIC COUNT	PUT UP	WEIGHT	WIDTH
902924	3000022	Charcoal	18 x 14	100 linear ft.	3.3 oz.	108 in.
902826	3003379	Charcoal	18 x 14	100 linear ft.	3.3 oz.	36 in.
902812	3003382	Charcoal	18 x 14	100 linear ft.	3.3 oz.	48 in.
902941	3003384	Charcoal	18 x 14	100 linear ft.	3.3 oz.	60 in.
902822	3000063	Charcoal	18 x 14	100 linear ft.	3.3 oz.	84 in.
902828	3000019	Charcoal	18 x 16	100 linear ft.	3.3 oz.	36 in.
902829	3000016	Charcoal	18 x 16	100 linear ft.	3.3 oz.	48 in.
902815	3002652	Charcoal	18 x 16	600 linear ft.	3.3 oz.	48 in.
902854	3002526	Charcoal	18 x 16	100 linear ft.	3.3 oz.	60 in.
902814	3002660	Charcoal	18 x 16	600 linear ft.	3.3 oz.	60 in.
902819	3002527	Charcoal	18 x 16	100 linear ft.	3.3 oz.	72 in.
902795	3002668	Charcoal	18 x 16	600 linear ft.	3.3 oz.	72 in.
902807	3003518	Charcoal	20 x 20	100 linear ft.	3.3 oz.	36 in.
902859	3003519	Charcoal	20 x 20	100 linear ft.	3.3 oz.	48 in.
902823	3003520	Charcoal	20 x 20	100 linear ft.	3.3 oz.	60 in.
902920	3003521	Charcoal	20 x 20	100 linear ft.	3.3 oz.	72 in.
902825	3003866	Charcoal	20 x 30	100 linear ft.	3.3 oz.	84 in.
902849	3003321	Silver Gray	18 x 14	100 linear ft.	3.3 oz.	48 in.
902858	3003324	Silver Gray	18 x 14	100 linear ft.	3.3 oz.	60 in.
902856	3003326	Silver Gray	18 x 14	100 linear ft.	3.3 oz.	72 in.
902821	3003328	Silver Gray	18 x 14	100 linear ft.	3.3 oz.	84 in.
902850	3002201	Silver Gray	18 x 16	100 linear ft.	3.3 oz.	36 in.
902852	3002209	Silver Gray	18 x 16	100 linear ft.	3.3 oz.	48 in.
902857	3002257	Silver Gray	18 x 16	600 linear ft.	3.3 oz.	48 in.
902853	3002212	Silver Gray	18 x 16	100 linear ft.	3.3 oz.	60 in.
902863	3002215	Silver Gray	18 x 16	100 linear ft.	3.3 oz.	72 in.
902862	3002218	Silver Gray	18 x 16	100 linear ft.	3.3 oz.	84 in.
902864	3003502	Silver Gray	20 x 20	100 linear ft.	3.3 oz.	48 in.
902891	3003504	Silver Gray	20 x 20	100 linear ft.	3.3 oz.	72 in.
902824	3003505	Silver Gray	20 x 20	100 linear ft.	3.3 oz.	84 in.

Phifer® is a registered trademark of Phifer Incorporated.

Phifer® TuffScreen®

This heavy-duty insect screening is three times stronger than regular insect screening. Pet-resistant and tear and puncture-resistant, it is ideal for use in high traffic areas.

TuffScreen is infused with Microban® antimicrobial product protection, helping to provide an additional level of cleanliness protection that won't wash or wear away for the lifetime of the screen. Microban® protection inhibits the growth of stain and odor-causing bacteria, mold and mildew and works continuously, keeping screens cleaner for longer. This product is GREENGUARD® and GREENGUARD® Gold certified.

ITEM #	COLOR	PUT UP	WIDTH
902771	Black	100 ft.	48 in.

TuffScreen® and Phifer® are registered trademarks of Phifer Incorporated. Microban® is a registered trademark of Microban Products Company. GREENGUARD® is a registered trademark of GREENGUARD Environmental Institute.

Phifer® UltraVue®

UltraVue is an excellent visibility screen (eVis) that offers a premium viewing experience. It is designed for 15% greater openness providing 25% better airflow. Ideal for windows or low traffic applications where the focus is on the view

UltraVue is infused with Microban® antimicrobial product protection, helping to provide an additional level of cleanliness protection that won't wash or wear away for the lifetime of the screen. Microban® protection inhibits the growth of stain and odor-causing bacteria, mold and mildew and works continuously, keeping screens cleaner for longer. This product is GREENGUARD® and GREENGUARD® Gold certified.

FABRIC	Woven Vinyl Coat Polyester
FINISH	Vinyl PVC

ITEM #	COLOR	FABRIC COUNT	PUT UP	WIDTH
902756	Black	20 x 20	100 ft.	72 in.

Phifer® and UltraVue® are registered trademarks of Phifer Incorporated. Microban® is a registered trademark of Microban Products Company. GREENGUARD® is a registered trademark of GREENGUARD Environmental Institute.

Phifer® Solar Insect Screening

A mesh screening of woven fiberglass. Dimensionally stable – does not shrink or stretch. Will not corrode. Unaffected by salt air, smoke and fumes. Excellent impact resistance. Will not support combustion. Easily fabricated for windows and doors. Not recommended for swimming pool covers because of the effects of chlorine on the fabric. This product is GREENGUARD® and GREENGUARD® Gold certified.

FABRIC	Vinyl Coated Fiberglass
FINISH	PVC over Fiberglass
FR STANDARDS MET	FL-L.S.-125B

ITEM #	STYLE #	COLOR	FABRIC COUNT	PUT UP	WEIGHT	WIDTH
902811	3003863	Charcoal	20 x 30	100 linear ft.	3.3 oz.	48 in.
902831	3003864	Charcoal	20 x 30	100 linear ft.	3.3 oz.	60 in.
902809	3003865	Charcoal	20 x 30	100 linear ft.	3.3 oz.	72 in.
902808	3003847	Silver Gray	20 x 30	100 linear ft.	3.3 oz.	48 in.
902830	3003848	Silver Gray	20 x 30	100 linear ft.	3.3 oz.	60 in.

Phifer® is a registered trademark of Phifer Incorporated. GREENGUARD® is a registered trademark of GREENGUARD Environmental Institute.

Phifer® PetScreen®

A heavy-duty, vinyl-coated polyester insect screening, PetScreen is seven times stronger than traditional insect screening and resists tears, punctures and other damage caused by pets and heavy wear in high traffic areas. Suggested uses: excellent for exterior screen doors where pet resistance is needed.

PetScreen® is infused with Microban® antimicrobial product protection, helping to provide an additional level of cleanliness protection that won't wash or wear away for the lifetime of the fabric. Microban protection inhibits the growth of stain and odor-causing bacteria, mold and mildew and works continuously, keeping fabrics cleaner for longer. This product is GREENGUARD® and GREENGUARD® Gold certified.

FABRIC	Woven Vinyl Coat Polyester
FINISH	Vinyl PVC
FR STANDARDS MET	California Technical Bulletin 117

ITEM #	COLOR	PUT UP	WEIGHT	WIDTH
902800	Black	100 ft.	11 oz.	36 in.
902798	Black	100 ft.	11 oz.	48 in.
902785	Black	100 ft.	11 oz.	60 in.
902787	Black	100 ft.	11 oz.	72 in.

Phifer® and PetScreen® are registered trademarks of Phifer Incorporated. Microban® is a registered trademark of Microban Products Company. GREENGUARD® is a registered trademark of GREENGUARD Environmental Institute.

Phifer® Aluminum Screening

Aluminum screening for all window, door and porch applications.

FABRIC	Aluminum
---------------	----------

ITEM #	COLOR	FABRIC COUNT	PUT UP	WIDTH
901885	Brite Bronze	18 x 14	100 ft.	60 in.
901881	Brite-Kote	18 x 16	100 ft.	60 in.

Phifer® is a registered trademark of Phifer Incorporated.

Duvetyne

Blackout material commonly used by theaters, movie and video production facilities, stage supply shops, grip departments and other production companies. Fabric is dyed black and napped on one side. For interior uses such as scenery backdrops and curtains. 10 oz. version is commonly referred to as "commando."

Laundering fabric may damage the finish.

FABRIC	Cotton
FR STANDARDS MET	NFPA 701, Test Method 1

ITEM #	COLOR	PUT UP	WEIGHT	WIDTH
768498	Black	100 yd.	10 oz.	54 in.
768492	Black	100 yd.	7.5 oz.	54 in.
768491	Black	100 yd.	7.5 oz.	54 in.
768495	Black	100 yd.	7.5 oz.	54 in.

Scenery Fabrics – Non-Flame Resistant, Unbleached

For use in theaters, schools, radio and film studios, and by drama groups as curtains and backdrops.

FABRIC	Cotton				
ITEM #	DESCRIPTION	PUT UP	WEIGHT	WIDTH	
642118	Unbleached Sheeting (Type 128)	300 yd.	4 oz.	108 in.	

High Temperature Cloth

An exceptionally rugged Aramid base fabric that stands up to high-heat environments without sacrificing strength, thermal protection or dimensional stability. Continuous protection to 600° F.

An excellent choice for heat containment blankets and shields.

FABRIC	Aramid Base				
FINISH	GEA Coating				
ITEM #	STYLE #	PUT UP	WEIGHT	WIDTH	
903025	FL1700	50 yd.	17 oz.	40 in.	

Silicone-Coated Fiberglass Cloth

High-temperature resistance and incombustible properties make Silicone-Coated Fiberglass Cloth suitable for removable insulation, pads, drop cloths, welding curtains, welding shields, welding, blankets, hose coverings, and gasketing.

FABRIC	Fiberglass				
FINISH	Silicone Coated				
FR STANDARDS MET	Federal Test Method 191A/M5903.1				
ITEM #	STYLE #	COLOR	PUT UP	WEIGHT	WIDTH
903017	SGL1700	Gray	50 yd.	17 oz.	60 in.

Polyester Filter Cloth

FABRIC	Multifilament Polyester Twill				
ITEM #	STYLE #	COLOR	PUT UP	WEIGHT	WIDTH
999406	5038-2	Natural	100 yd.	5 oz.	53 in.

Polypropylene Filter Fabric

Lightweight, strong polypropylene fabric with excellent resistance to most acids and alkalis. For swimming pool filters, air filters, dye production and dust collection. This cloth has a low density. Air permeability 20-30 CFM at 1/2 inch pressure drop.

FABRIC	Polypropylene					
ITEM #	STYLE #	COLOR	FABRIC COUNT	PUT UP	WEIGHT	WIDTH
999412	7027-3-4 (7001)	Natural	76 x 60	100 yd.	4.1 oz.	54 in.

Polypropylene Trampoline Fabric

For trampoline beds. Hot slit selvage; suggest folding under for finished hem.

FABRIC	Polypropylene					
ITEM #	STYLE #	COLOR	PUT UP	WEIGHT	WIDTH	
902889	24109	Black	100 yd.	7.6 oz.	155 in.	
902880	2045709/24119	Black	100 yd.	7.6 oz.	74 in.	

Windscreen

A perfect backdrop and windscreen fabric made of polypropylene. Its porous construction is the ideal windbreak. Retains its size and color, and will not mildew. Has great strength and abrasion resistance. Is lightweight – just fasten to existing fences. Stays light – will not absorb water. Cuts the wind and shades the glare for a cooler court and better playing conditions.

FABRIC	Polypropylene					
ITEM #	STYLE #	DESCRIPTION	COLOR	PUT UP	WEIGHT	WIDTH
902915	21619	Closed Mesh	Black	100 yd.	5.6 oz.	75 in.
902871	21612	Closed Mesh	Green	100 yd.	5.6 oz.	75 in.
902895	20229	Open Mesh	Black	100 yd.	4.9 oz.	75 in.
902870	20812	Open Mesh	Green	100 yd.	4.9 oz.	75 in.

Pooltex

A strong and durable fabric, specially designed for pool covers. Lightweight – easy to handle and fabricate. Resists alkalis, acids, sun's rays and mildew.

FABRIC	Polypropylene Mesh					
ITEM #	STYLE #	COLOR	PUT UP	WEIGHT	WIDTH	
902917	22509	Black/Black	150 yd.	4.2 oz.	73 in.	
902875	26502/22602	Black/Green	150 yd.	4.2 oz.	73 in.	
902874	24503	Blue/Black	150 yd.	4.2 oz.	73 in.	

Architent®

A premium, vinyl laminated polyester tent fabric, formulated for superior abrasion, mildew and UV ray resistance.

FABRIC	Vinyl Laminated Polyester
FR STANDARDS MET	California State Fire Marshal

ITEM #	DESCRIPTION	COLOR	PUT UP	WEIGHT	WIDTH
973080	Blackout	White	75 yd.	16 oz.	61 in.

Architent® is a registered trademark of Herculite Products Inc.

Architent WideSide®

A premium, vinyl laminated polyester tent fabric, formulated for superior abrasion, mildew and UV ray resistance.

FABRIC	Vinyl Laminated Polyester
FR STANDARDS MET	California State Fire Marshal

ITEM #	DESCRIPTION	COLOR	PUT UP	WEIGHT	WIDTH
973097	WideSide	White	100 yd.	13 oz.	98 in.

Architent® and WideSide® are registered trademarks of Herculite Products Inc.

Renter's Choice

Designed for canopy, tent, and indoor and outdoor banner jobs, this fabric is durable and easy to keep clean. Finished with a high gloss emboss, the fabric always looks great. Renter's Choice is resistant to water, mildew, rot and ultraviolet rays. Plus, it's heat sealable and flame retardant. The fabric can be digitally printed with either UV curable or solvent inkjet systems.

FABRIC	Vinyl Laminated Polyester
FINISH	High Gloss Emboss
FR STANDARDS MET	California State Fire Marshal Title 19; NFPA 701 Test Method 2

ITEM #	DESCRIPTION	COLOR	PUT UP	WEIGHT	WIDTH
968300		White	50 yd.	10 oz.	61 in.
968310		White	50 yd.	10 oz.	98 in.
968320		White	100 yd.	13 oz.	61 in.
968330		White	50 yd.	13 oz.	98 in.
968340	Blackout	White	100 yd.	16 oz.	61 in.



Showtime® II

Showtime II provides excellent performance with a high gloss, ultra smooth surface and an extensive color offering.

FABRIC	Vinyl Laminated Polyester
FINISH	High Gloss Embossing
FR STANDARDS MET	California State Fire Marshal Title 19; NFPA 701
WARRANTY	2-Year

ITEM #	COLOR	PUT UP	WEIGHT	WIDTH
973337	Black	100 yd.	14 oz./ly.	61 in.
973312	Blue	100 yd.	14 oz./ly.	61 in.
973305	Bright Red	100 yd.	14 oz./ly.	61 in.
973339	Dark Blue	100 yd.	14 oz./ly.	61 in.
973299	Forest Green	100 yd.	14 oz./ly.	61 in.
973335	Gray	100 yd.	14 oz./ly.	61 in.
973334	Kelly Green	100 yd.	14 oz./ly.	61 in.
973304	Lime Green	100 yd.	14 oz./ly.	61 in.
973309	Orange	100 yd.	14 oz./ly.	61 in.
973308	Pink	100 yd.	14 oz./ly.	61 in.
973302	Purple	100 yd.	14 oz./ly.	61 in.
973340	Red	100 yd.	14 oz./ly.	61 in.
973342	Sand	100 yd.	14 oz./ly.	61 in.
973303	Turquoise	100 yd.	14 oz./ly.	61 in.
973300	White	100 yd.	14 oz./ly.	61 in.
973338	Yellow	100 yd.	14 oz./ly.	61 in.

Showtime® is a registered trademark of Herculite Products Inc.

Tex-Text®

A lightweight, water resistant, mildew resistant and flame-retardant tenting fabric, designed for family camping.

FABRIC	Texturized Polyester
FR STANDARDS MET	CPAI-84; NFPA 701
WARRANTY	None

ITEM #	STYLE #	COLOR	PUT UP	WEIGHT	WIDTH
767601	58601	Off White	150 yd.	4.25 oz.	61 in.

Tex-Text® is a trademark of Graniteville Specialty Fabrics.



General Care and Cleaning Instructions for Selected Fabrics

Trivantage® offers the finest awning and marine fabrics in the industry, but proper maintenance is important if maximum life of the end product is desired. The following are suggestions for care and cleaning of selected fabrics, but the general guidelines – keep dirt, leaves and debris from accumulating on the surface, wash regularly with water, avoid dragging on rough surfaces, etc. – pertain to all fabrics used in outdoor applications.

Note: Trivantage offers a complete line of cleaning and protection products for industrial fabrics. See your Trivantage Distribution Center for more information.

Tips on Care of Trivantage Awning Fabrics

The life and good looks of your awnings depend a great deal on the way you use them and how you care for them. Your awnings are made from either a cotton or synthetic fabric, either of which is the finest awning fabric available. We use only the best available water repellents and mildew retardants in Trivantage awning fabrics and you can rely on our experience and quality. Even the most durable materials require a certain amount of care, and fabric awnings are no exception. With only the minimum amount of attention, your awnings will remain bright and serviceable. The following do's and don'ts are presented to help you in the proper care of your awning. The life and beauty of an awning can be preserved by following these suggestions and general tips.

Some Do's

Do keep the awnings clean. This is the best protection against mildew. Even on mildew resistant fabric, mildew can grow on accumulated dirt or foreign materials which remain on the top or bottom surface and eventually damage or stain the fabric. We cannot be responsible for such damage.

Do wash down your awnings. If they are vinyl coated, brush lightly with a cloth or soft brush. You can use a mild soap, but rinse thoroughly and immediately.

Do hose your awning with clean water occasionally, every month or so. We recommend that you do this on a hot, sunny day.

Do keep the underside of your awnings clean by simply brushing with a clean household broom.

Do keep shrubbery and vines away from the awnings, as many bushes contain an acid which can be harmful to your awnings.

Do check the condition of awning frames. Rust is not likely to form, but if it should it might cause deterioration or staining of the fabric.

Some Don'ts

Do Not fold or roll the awning in cold temperature.

Do Not drag your awning across any abrasive surfaces, such as cement, asphalt, or the awning frame.

Do Not get insect spray on the fabric, as some solutions may impair the water repellency of the fabric and cause staining.

Do Not allow water to stand on the awnings, causing pocketing and possible stretching.

Do Not overlook small rips or tears. If a sharp object punctures the fabric, it should be repaired.

Do Not wash your awnings with a harsh or strong solution, or scrub too vigorously with an abrasive cleaner.

Do Not force or yank your awnings when raising or lowering them. Do it gradually.

Do Not cook food or have fires beneath or around the awning.

Do Not store awnings when damp or wet. Mildew is a fabric's greatest foe and is caused by dampness. Mildew may grow on the surface of a damp awning and permanently stain the fabric.

Do Not permit leaves, twigs, dirt etc. to remain on your awnings as they might cause a staining of the fabric.

Trivantage® is a registered trademark of Glen Raven, Inc.

Aqualon® Edge

7-Year

Aqualon® Edge is warranted for a period of seven years (7) from the date of the installation in a marine cover, top or enclosure end uses. The warranty protects the end user from excessive loss of color or strength from normal exposure conditions including sunlight, mildew, rot and normal atmospheric chemicals which may render the fabric unserviceable. This warranty does not cover seam leakage, covers used on trailered boats, damage from Acts of God, vandalism, neglect or improper cleaning and improper use. Please see your Trivantage, LLC representative for cleaning instructions.

In the unlikely event of fabric failure during the warranty period Graniteville Specialty Fabrics will supply the end product fabricator or Trivantage, LLC new fabric free of charge equal to the fabric used in the end use item. Labor and installation are not covered by this warranty. Graniteville Specialty Fabrics reserves the right to inspect the fabric or made up item of any warranty claim.

Except for the explicit warranties, herein, no other warranty, expressed or implied, including any implied warranty of merchantability of fitness for a particular use is made by Graniteville Specialty Fabrics. In no event shall Graniteville Specialty Fabrics be liable for damages to any person or property, or any consequential or incidental damages.

Some states do not allow limitations on how long an implied warranty lasts or the exclusion or limitation of consequential or incidental damage, so, the above limitation or exclusion may not apply to you. This warranty gives you specific legal rights and you may have other rights which vary from state to state.

To get service, call the dealer from whom you purchased the product. The dealer will inspect the installation and process the claim through Trivantage, LLC and Graniteville Specialty Fabrics.

Graniteville Specialty Fabrics

Aqualon® is a registered trademark of Glen Raven, Inc.

AwnTex® 70, 120 and 160

5-Year

Extended Limited Warranty

What Is Covered? This warranty covers the fabric becoming nonfunctional because of loss of dimensional stability from exposure conditions including sunlight, mildew, rot and normal atmospheric conditions. It does not cover discoloration from atmospheric pollution or other debris.

How Long Is The Coverage Period? The warranty coverage runs for five (5) years from the date of original installation.

What Will Phifer Do? Phifer Incorporated will provide new fabric, free, to replace the non-functioning fabric. This warranty does not cover the cost of labor or other consequential or incidental expenses.

How Can You Get Service? Call the dealer from whom you purchased the product. They will contact Trivantage, LLC who will secure the new material from Phifer and ship to the dealer. This warranty is valid only if a sample of the fabric, with defects, is submitted with a photograph of the installation and an invoice showing the item and date purchased.

This is the complete and only warranty provided for AwnTex brand fabric. There are no other warranties, expressed or implied, for this product.

Phifer Inc.

AwnTex® is a registered trademark of Glen Raven, Inc.

Architec 400®

12-Year Against UV Degradation

12 YEAR ULTRA VIOLET WARRANTY

ARCHITEC 400® is a unique and innovative Extra Heavy Duty knitted shade cloth designed for architectural sails and commercial shade structures.

Warranty

Polyfab Australia Pty Ltd (Polyfab) warrants to the initial purchaser that the fabric will not suffer from abnormal deterioration (*) from ultra violet exposure for a period of 12 years from the date of installation. (*Abnormal deterioration means deterioration exceeding 5% of the fabrics original strength for each year over the 12 year warranty period).

If the fabric does suffer from abnormal deterioration during the 12 year warranty period, Polyfab will, at its option either replace the fabric or supply equivalent fabric, or pay the cost of replacing the fabric or of acquiring equivalent fabric.

Exclusions

This warranty does not cover, and Polyfab is not liable for, deterioration of fabric occurring due to any of the following circumstances:

- Exposure to pollution, chemicals, solvents, cleaning agents or other substances that are harmful to the performance of the fabric.
- Faulty installation of the fabric or faulty design or manufacture of any structure to which the fabric is attached.
- Improper use of the fabric or use contrary to the specifications for the fabric.
- Color fading or variation due to ultraviolet exposure.
- Minor color variation from fabric samples.
- Minor visual imperfection due to the manufacturing processes.
- The negligent act or omission of any person.
- Misuse, neglect or abuse of the fabric.

Statutory Implied Terms and Limitation

This warranty is in addition to any non-excludable terms, conditions or warranties implied under the Trade Practices Act 1974 (Cth) or similar Commonwealth or State legislation ('Statutory Terms').

Polyfab's liability for breach of the Statutory Terms is limited to the maximum extent permitted by the Statutory Term or otherwise by law.

Save as expressly provided in this warranty and the Statutory Terms:

- a) all implied conditions and warranties with respect to the goods and services supplied by Polyfab including without limitation warranties as to quality, fitness for purpose and sale by sample are excluded;
- b) Polyfab shall not be liable for any direct, indirect or consequential loss or damage which arises out of the negligence or carelessness of Polyfab or any of its employees, servants, contractors, suppliers or agents, or which arises directly or indirectly from the use of any information, advice or recommendation of any Polyfab employee or from any alleged breach of duty in respect of any goods or services supplied by Polyfab;
- c) Polyfab shall not be liable for any advice given by its agents or employees in relation to the suitability for the purpose of goods supplied by Polyfab.

Claims Procedure

1. All claims must be in writing addressed to Polyfab Australia Pty Ltd, 63 Frankston Gardens Drive, Carrum Downs, Victoria 3201, and must be made within 30 days from the date upon which the defect became known.
2. Claims must be supported by a sample of the defective fabric together with proof of place and date of purchase of the fabric.

POLYFAB AUSTRALIA Pty. Ltd.
 Architec 400® is a registered trademark of Polyfab USA.

Calabaña®

5-Year

Limited Warranty

Calabaña®, a registered trademark of Graniteville Specialty Fabrics, is warranted for a period of five years from the date of the original installation against excessive loss of color or strength from normal exposure conditions including sunlight, rot and normal atmospheric chemicals which may render the fabric unserviceable. This warranty does not cover damage from Acts of God, vandalism, neglect or improper use.

In the unlikely event of fabric failure during the warranty period, Graniteville Specialty Fabrics will supply you, the end consumer, new fabric free of charge working through Trivantage and your dealer. Labor and installation are not covered by this warranty. Graniteville Specialty Fabrics reserves the right to inspect the fabric or made up item of any warranty claim.

Except for the explicit warranties, herein, no other warranty, expressed or implied, including any implied warranty of merchantability of fitness for a particular use is made by Graniteville Specialty Fabrics. In no event shall Graniteville Specialty Fabrics be liable for damages to any person or property, or any consequential or incidental damages.

Some states do not allow limitations on how long an implied warranty lasts or the exclusion or limitation of consequential or incidental damage, so, the above limitation or exclusion may not apply to you. This warranty gives you specific legal rights and you may have other rights which vary from state to state.

To get service, call the dealer from whom you purchased the product. The dealer will inspect the installation and process the claim through Trivantage, LLC and Graniteville Specialty Fabrics.

Graniteville Specialty Fabrics
 Calabaña® is a registered trademark of Graniteville Specialty Fabrics.

Commercial FR 300 (SaFRshade™)

10-Year Against UV Degradation

Pro Rata Product Warranty and Limitation of Liability Commercial FR 300 is a high quality knitted shade fabric designed for tension structures, awnings and shade covers, where a level flame retardancy is required. It is manufactured using high quality ingredients that have been selected for their resistance to ultra violet light degradation with the addition of proprietary flame retardant additives. The product is manufactured by Gale Pacific Limited ACN 082 263 778 ("Gale Pacific"), an ISO9002 accredited company.

Warranty

If, as a direct result of ultra-violet exposure, this product cracks, splits or tears due to a product defect within 8 years from the date on which the product is purchased from Gale Pacific or an authorized distributor or agent of Gale Pacific, Gale Pacific will, at its option, provide replacement of the fabric component of the product (but not any other component) free of charge if the failure is within 1 year of purchase or refund the cost of the material only on a pro-rata basis thereafter.

Gale Pacific's Obligations under limited WARRANTY: Gale Pacific agrees to provide, to the extent and for the time period stated in the chart below a percentage of the cost to repair or replace at Gale Pacific's sole option, the products which may prove defective or otherwise fail to perform as stated above under normal use, maintenance and service, as determined by Gale Pacific during the warranty period (a "Defect" or "Defective Product"), not to exceed the original sales price to the original purchaser of the Product. The customer must pay the remaining portion of any such costs or repair or replacements of a Defective Product:

Percentage of Gale Pacific Liability

Failure occurs in year	1st year	2nd year	3rd year	4th year	5th year	6th year	7th year	8th year
% of cost assumed by Gale Pacific	100%	80%	64%	50%	40%	30%	20%	10%

This warranty is subject to the following conditions and limitations:

1. All claims under this warranty must be made in writing addressed to Gale Pacific Limited, PO Box 892, Braeside, Victoria, 3195, Australia or, if the product was purchased in North America, to Gale Pacific Inc, PO Box 162625, Altamonte Springs, Florida 32716-2625, USA or, if the product was purchased in the Middle East, to Gale Pacific FZE, PO Box 17696, Jebel Ali, Dubai, United Arab Emirates.

All claims must be accompanied by a sample of the fabric for laboratory testing and proof of place and date of purchase of the product.

2. Gale Pacific will not be liable for any claim made under this warranty in respect of any product in any of the following circumstances:
 - If the defect is contributed to or caused by any improper use of the product or usage of the product for purposes other than that for which the product was designed or intended.
 - If the defect occurs wholly or partly as a result of any act or omission of any person other than Gale Pacific.
 - If the product has been subjected to misuse, neglect, accident or abuse.
 - If the product is altered or modified in any way contrary to advice provided in writing by Gale Pacific.
 - If the product is joined in a manner which subsequently causes the fabric to tear, split, crack or separate.
 - If the product is subject to excessive abrasion against solid or permanent surfaces while under tension.

- If the product is erected, installed, or used in violation of, or in a manner that is inconsistent with, instructions or warnings furnished by Gale Pacific.

3. This warranty does not cover:

- Color fading of the product (even if due to exposure of the product to ultra-violet rays) or a deterioration in the chemical composition of the fabric other than a deterioration in the chemical composition of the fabric that occurs as a direct result of a defect; or
- Any damage to the product caused or contributed to by exposing the product to chemicals (including chlorine, halogens and organic solvents), highly acidic substances (with a pH less than 4), placing the product near an open flame (including flames from a barbecue), tensioning the product beyond its tear and tensile capabilities or mechanical friction.

Note: Shade sails or structures that are greater than 1.8 meters above a swimming pool should not be adversely affected by normal chlorine levels in a swimming pool. Direct contact with chlorine and other halogens can lead to degradation of the UV stabilizers and may negate the warranty.

4. This warranty is not transferable, and applies only to the initial purchaser of the installed product.

5. This warranty applies to the fabric only.

In addition to the above warranty and other State and Territory legislation may imply warranties or conditions or impose liability on Gale Pacific in relation to the product or its supply which cannot, or can only to a limited extent, be excluded, restricted or modified.

Except for those implied warranties or conditions and such liability, and for the warranty described above, all warranties and conditions (whether express or implied, statutory or otherwise) relating to the product or its supply are expressly excluded; and Gale Pacific will not be liable for any loss or damage suffered by any person (including the purchaser of the product) in any way relating to or arising from the product or its use (including loss or damage arising from the negligence of, or contributed to by, Gale Pacific).

If liability for breach by Gale Pacific of a warranty or condition or any other liability imposed on Gale Pacific by legislation which cannot be excluded may be limited, Gale Pacific's liability is limited to the extent permitted by law, and if liability may be limited in any one of a number of ways, Gale Pacific's liability is limited in any one of the permitted ways chosen by Gale Pacific in its absolute discretion.

Gale Pacific Pty. Ltd.

Commercial 95® 340

10-Year Against UV Degradation

Commercial 95® 340 is a high quality knitted shade fabric designed for tension structures, awnings, and shade covers. It is manufactured using high quality ingredients that have been selected for their resistance to ultra violet light degradation. The product is manufactured in Australia by Gale Pacific Limited ACN 082 263 778 ("Gale Pacific"), an ISO9002 accredited company.

Warranty

If, as a direct result of ultra-violet exposure, this product cracks, splits or tears ("defect") within 10 years after the date on which the product is purchased from Gale Pacific or an authorized distributor or agent of Gale Pacific, Gale Pacific will, at its option, replace the fabric component of the product (but not any other component) free of charge or refund the cost of such replacement. This warranty is subject to the following conditions and limitations:

1. All claims under this warranty must be made in writing addressed to Gale Pacific Limited, PO Box 892, Braeside, Victoria, 3195, Australia or, if the product was purchased in North America, to Gale Pacific USA, 285 West Central Parkway, Suite 1704, Altamonte Springs, Florida 32714, or, if the product was purchased in the Middle East, to Gale Pacific FZE, PO Box 17696, Jebel Ali, Dubai, United Arab Emirates. All claims must be accompanied by a sample of the fabric for laboratory testing and proof of

place and date of purchase of the product.

2. Gale Pacific will not be liable for any claim made under this warranty in respect of any product in any of the following circumstances:

- If the defect is contributed to or caused by any improper use of the product or usage of the product for purposes other than that for which the product was designed or intended.
- If the defect occurs wholly or partly as a result of any act or omission of any person other than Gale Pacific.
- If the product has been subjected to misuse, neglect, accident or abuse.
- If the product is altered or modified in any way unless such modification has been approved in writing by Gale Pacific.
- If the product is erected, installed, or used in violation of, or in a manner that is inconsistent with, instructions or warnings furnished by Gale Pacific.

3. This warranty does not cover:

- Color fading of the product (even if due to exposure of the product to ultra-violet rays) or a deterioration in the chemical composition of the fabric other than a deterioration in the chemical composition of the fabric that occurs as a direct result of a defect; or
- Any damage to the product caused or contributed to by exposing the product to chemicals (including chlorine, halogens and organic solvents), highly acidic substances (with a pH less than 4), placing the product near an open flame (including flames from a barbecue), tensioning the product beyond its tear and tensile capabilities or mechanical friction.

Note: Shade sails or structures that are greater than 1.8 meters above a swimming pool should not be adversely affected by normal chlorine levels in a swimming pool. Direct contact with chlorine and other halogens can lead to degradation of the UV stabilizers and may negate the warranty.

4. This warranty is not transferable, and applies only to the initial purchaser of the installed product.

5. This warranty applies to the fabric only.

In addition to the above warranty, the Trade Practices Act 1974 (Cth) and other state and territory legislation may imply warranties or conditions or impose liability on Gale Pacific in relation to the product or its supply, which cannot, or can only to a limited extent, be excluded, restricted or modified. Except for those implied warranties or conditions and such liability, and for the warranty described above:

- All warranties and conditions (whether express or implied, statutory or otherwise) relating to the product or its supply are expressly excluded; and
- Gale Pacific will not be liable for any loss or damage suffered by any person (including the purchaser of the product) in any way relating to or arising from the product or its use (including loss or damage arising from the negligence of, or contributed to by, Gale Pacific).

If liability for breach by Gale Pacific of a warranty or condition or any other liability imposed on Gale Pacific by legislation which cannot be excluded may be limited, Gale Pacific's liability is limited to the extent permitted by law, and if liability may be limited in any one of a number of ways, Gale Pacific's liability is limited in any one of the permitted ways chosen by Gale Pacific in its absolute discretion.

Gale Pacific Pty. Ltd.

Commercial 95® is a registered trademark of Gale Pacific Ltd. of Australia

Comtex®

10-Year Against UV Degradation

UV PERFORMANCE WARRANTY FOR POLYTEX® & COMTEX®

POLYTEX® and COMTEX® EXTRA HEAVY DUTY KNITTED SHADECLOTH ("fabric") are premium fabrics designed for use in shade structures and shade sails.

Warranty

Polyfab USA LLC ("Polyfab") warrants to the initial purchaser that the fabric will not suffer from abnormal deterioration from ultra violet exposure for a period of 10 years from the date of installation. The term abnormal deterioration means the fabric has mechanically failed during the actual application in the shading environment intended for such fabric. Such abnormal deterioration is defined by a measure of loss of tensile and tear strength (both in warp and weft direction) that is greater than 5% per annum; if such degradation of tensile strength has been caused by ultra violet radiation and the chemical processes that ultra violet radiation initiates in the plastics and the additives alone. The maximum working load of the fabric should not exceed 60% of the break strength in both warp and weft directions. This warranty does not include normal fading or wear and tear. Fading, by itself, is not an indication of loss of strength due to ultra violet radiation. If the fabric does suffer from abnormal deterioration during the 10-year warranty period, Polyfab will, at its option either replace the fabric or supply equivalent fabric, or pay the cost of replacing the fabric or of acquiring equivalent fabric.

POLYFAB UNDERTAKES NO RESPONSIBILITY FOR THE QUALITY OF THE FABRIC EXCEPT AS OTHERWISE PROVIDED HEREIN. THERE IS NO IMPLIED WARRANTY THAT THE FABRIC SHALL BE MERCHANTABLE. POLYFAB ASSUMES NO RESPONSIBILITY THAT THE FABRIC WILL BE FIT FOR ANY PARTICULAR PURPOSE FOR WHICH YOU MAY BE BUYING THE FABRIC, EXCEPT AS OTHERWISE PROVIDED HEREIN. THERE IS NO IMPLIED WARRANTY THAT THE FABRIC SHALL BE FIT FOR ANY PARTICULAR PURPOSE. YOU ACKNOWLEDGE THAT YOU ARE NOT RELYING ON POLYFAB'S SKILL OR JUDGMENT TO SELECT OR FURNISH THE FABRIC SUITABLE FOR ANY PARTICULAR PURPOSE AND THAT THERE IS NO WARRANTY, WHICH EXTENDS BEYOND THAT PROVIDED HEREIN.

Exclusions

This warranty does not cover, and Polyfab is not liable for, deterioration of fabric occurring due to any of the following circumstances:

- Exposure to pollution, chemicals, solvents, cleaning agents or other substances that are harmful to the performance of the fabric.
- Faulty installation of the fabric or faulty design or manufacture of any structure to which the fabric is attached.
- Improper storing, handling, bracing, use of the fabric or use contrary to the specifications for the fabric.
- Color fading or variation due to ultraviolet exposure.
- Minor color variation from fabric samples.
- Minor visual imperfection due to the manufacturing processes.
- The negligent act or omission of any person.
- Misuse, neglect or abuse of the fabric.

Limitation of Liability

Polyfab's obligations and liabilities are expressly and exclusively limited to those set forth herein. POLYFAB SHALL NOT BE LIABLE FOR DIRECT, INDIRECT, INCIDENTAL, CONSEQUENTIAL, OR SPECIAL DAMAGES, INCLUDING LOSS OF PROFITS, OR OTHER COMMERCIAL LOSS, AND INCLUDING CLAIMS BASED ON NEGLIGENCE OR STRICT LIABILITY, EXCEPT AS OTHERWISE PROVIDED FOR HEREIN. NOTWITHSTANDING THE FOREGOING, ANY LIABILITY RELATED TO THE FABRIC SHALL BE LIMITED TO THE PURCHASE PRICE OF THE FABRIC.

Claims Procedure

All claims must be made in writing, within 30 days from the date upon which the defect became known, to Polyfab USA LLC, 1601 N. Sepulveda Blvd. #392, Manhattan Beach, CA 90266. Claims must be supported by a sample of the defective fabric together with proof purchase, including the date and location of fabric purchase.

POLYFAB AUSTRALIA Pty. Ltd.

Comtex® and Polytex® are registered trademarks of Polyfab USA LLC.

Cool Glo™ / Northstar®

5-Year

5-Year Limited Warranty

Izumi America, Inc. warrants that VT-1700FM (Cool Glo™ / Northstar®) fabric when used in an awning or a back-lit awning application will be free from defects in material and workmanship to include excessive change in color, loss of strength or mildew staining for a period of five (5) years from the date of installation.

If during the first twelve (12) months from date of installation, an awning fabricated using VT-1700FM exhibits excessive change in color, loss of strength or mildew staining to the extent the awning becomes ineffective for its intended purpose as a protective cover or a display when viewed from a distance of fifty (50) feet, the fabric will be replaced without charge.

From the thirteenth (13th) month to the sixtieth (60th) month, the fabric will be replaced at the then current price. An allowance equal to 1/60th of the current price will be deducted for each month still remaining in the warranty period.

This warranty does not cover damage by water run-off, water accumulation, chemicals, airborne particulate, accumulation of dirt or bird droppings. This warranty does not cover damage resulting from mishandling, poor or improper installation, poor or improper maintenance or willful neglect.

Liability under this warranty is limited to the replacement of fabric as stated herein and no liability for any direct or consequential loss is assumed.

NO WARRANTY OF MERCHANTABILITY, WARRANTY OF FITNESS FOR A PARTICULAR PURPOSE OR OTHER WARRANTY IS EXPRESSED OR IMPLIED OTHER THAN AS SET FORTH IN THIS LIMITED WARRANTY. NO REMEDIES ARE AVAILABLE OTHER THAN THE REMEDIES SET FORTH IN THIS LIMITED WARRANTY. THIS WARRANTY IS GIVEN IN LIEU OF ALL WARRANTIES, EXPRESSED OR IMPLIED, AND CONSTITUTES THE SOLE WARRANTY FOR VT-1700FM.

Izumi America, Inc.

Cool Glo™ is a trademark of Glen Raven, Inc.
Northstar® is a registered trademark of Glen Raven, Inc.

Cooley-Brite® / Cooley-Brite® Lite

8-Year

8-Year Limited Warranty*

Cooley Sign & Digital Products (CSDP) warrants to its customer, an electrical sign company engaged in fabricating and furnishing signs to various businesses, that standard colors of COOLEY- BRITE® and COOLEY-BRITE® LITE, when used as components for internally illuminated (90° vertical exposure application) displays will not fade excessively or undergo excessive color degradation or mildew staining to the extent that the sign becomes ineffective for its intended advertising or identification purpose when viewed at normal distance for a period of eight (8) years. If the material does not perform under the above conditions, (CSDP) will supply to the sign company sufficient materials to produce a new duplicate face at the then current price and will grant an allowance equal to 1/60th of the original purchase price for each month remaining in the initial eight-year period of use.

If the sign face is properly installed and maintained, and within the first eight (8) years from the date of purchase of materials, said face should be destroyed or severely damaged by a "blowout" (defined as a separation of a sign face from its cabinet due to wind pressure which does not affect the display cabinet or structure), and when such "blowout" is caused solely and completely by failure of CSDP sign face materials, and not in whole or part by improper workmanship, installation, materials, nor bending or twisting of the display cabinet, attachment devices, or structure, nor to the vandalism or malicious mischief, hurricanes, tornadoes, gales or other acts of God, CSDP will furnish to the sign company sufficient materials to produce a new duplicate face at then current price and will grant an allowance equal to 1/60th of the original purchase price for each month remaining in the initial eight-year period of use.

Cooley Sign & Digital Products further warrants that approved pressure sensitive vinyl* when applied to COOLEY-BRITE® and COOLEY-BRITE® LITE, will not peel off under normal weathering conditions for a period of eight years. If the pressure sensitive vinyl should peel off under the above conditions, Cooley Sign & Digital Products will supply new materials to restore the sign at then current prices and will grant an allowance 1/60th of the original purchase price for each month remaining in the initial eight year period of use.

The foregoing is not applicable to sign faces which have been damaged by chemicals, airborne particle or dirt, bird droppings, or water run-off, nor to the sign faces damaged by willful neglect or negligent mishandling, nor to sign faces which excessively fade or discolor due to use of non-recommended decorating techniques.

CSDP's liability under the warranty is limited to replacement as stated herein and CSDP will have no liability for any indirect or consequential expenses or losses. No replacement will be made for any sign face which has been in use for more than the initial eight-year period.

This warranty is given in lieu of all other warranties expressed or implied and constitutes CSDP's sole eight (8) year warranty for COOLEY- BRITE® and COOLEY-BRITE® LITE, for sign usage.

COOLEY-BRITE® AND COOLEY-BRITE® LITE FOR BACKLIT AWNINGS

Cooley Sign & Digital Products (CSDP) warrants to its customers that standard colors of COOLEY- BRITE® and COOLEY-BRITE® LITE when used in a backlit awning application, and when fabricated, installed and maintained according to instructions, will not fade excessively or undergo excessive color degradation or mildew staining to the extent that the awning becomes ineffective for its intended advertising or identification purpose when viewed at a normal distance for a period of eight (8) years. If the material does not perform under the above conditions, CSDP will supply to the awning company sufficient COOLEY-BRITE® and COOLEY-BRITE® LITE material to produce a new duplicate awning at the then current price and will grant an allowance equal to 1/60th of the original purchase price for each month remaining in the initial eight year period of use.

Cooley Sign & Digital Products further warrants that approved pressure sensitive vinyl when applied to COOLEY- BRITE® and COOLEY-BRITE® LITE will not peel off under normal weathering conditions for a period of five years. If the pressure sensitive vinyl should peel off under the above conditions, Cooley Sign & Digital Products will supply new material to restore the awning at the ten current prices and will grant an allowance equal to 1/60th of the original purchase price of each month remaining in the initial five year period of use.

The foregoing is not applicable to awnings which have been damaged by chemicals, airborne particles or dirt, bird droppings, or water run-off, nor to awnings damaged by willful neglect or negligent mishandling, nor to awnings which excessively fade or discolor due to use of non-recommended decorating techniques. CSDP's, liability under the warranty is limited to replacement as stated herein and CSDP will have no liability for any indirect or consequential expenses or losses. No replacement will be made for any awning which has been in use for more than the initial five year period.

This warranty is given in lieu of all other warranties expressed or implied and constitutes CSDP's sole eight (8) year warranty for COOLEY- BRITE® and COOLEY-BRITE® LITE when used for backlit awnings.

* 8-year warranty period begins with the date of the fabrication, but it will not extend more than 1/2 years from the date of manufacture by CSDP. Shelf-life is 2 years from date of manufacture by CSDP

Cooley Sign & Awning Products

Cooley-Brite® is a registered trademark of Cooley, Inc.

Cooley-Brite® II with Coolthane® EPS

10-Year

10-Year Limited Warranty*

Cooley Sign & Digital Products (CSDP) warrants to its customer, an electrical sign company engaged in fabricating and furnishing signs and awnings to various businesses, that COOLEY BRITE® II when coated at the factory, with EPS clear protective top coating and used as components of internally illuminated displays will not fade excessively or undergo excessive color degradation to the extent that the display becomes ineffective for its intended advertising or identification purpose when viewed at a normal distance of 50 ft. for a period of 10 years.

CSDP warrants that COOLEY BRITE® II when coated at the factory with EPS clear protective top coating will remain cleanable when using CSDP's cleaning products or approved equivalents with approved cleaning techniques.

Any eradicated areas of COOLEY BRITE® II must be re- sprayed with COOLTHANE® spray or other approved decorating methods.

If the material fades or undergoes excessive color degradation as described above, CSDP will supply to the sign or awning company sufficient COOLEY BRITE® II material to produce a new duplicate sign or awning at the then current price and will grant an allowance equal to 1/96th of the original purchase price for each month remaining in the 10-year period of use.

The foregoing is not applicable to sign faces or awnings, which have been damaged by chemicals, neglect or mishandling, nor to signs or awnings which excessively fade or discolor due to use of non-recommended decorating or cleaning techniques.

CSDP's liability under warranty is limited to replacement as stated herein and CSDP will have no liability for any incidental or consequential losses or expenses. No replacement will be made for any sign or awning, which has been in use for more than the 10-year period.

CSDP will have no obligation under this warranty until all bills for material have been paid in full. During the term of this warranty, CSDP employees or agents shall have free access to the signs and awnings during regular business hours.

THIS WARRANTY IS GIVEN IN LIEU OF ALL WARRANTIES EXPRESS OR IMPLIED AND CONSTITUTES CSPD'S SOLE TEN (10) YEAR WARRANTY FOR COOLEY BRITE II WHEN USED IN BACKLIT SIGNS OR AWNINGS.

THERE IS NO WARRANTY OF MERCHANTABILITY, WARRANTY OF FITNESS FOR A PARTICULAR PURPOSE OR OTHER WARRANTY EXPRESS OR IMPLIED OTHER THAN AS SET FORTH IN THIS WARRANTY. IN ADDITION, THERE ARE NO REMEDIES AVAILABLE OTHER THAN THE REMEDIES SET FORTH IN THIS LIMITED WARRANTY.

* 10-year warranty period begins with the date of the fabrication, but it will not extend more than 10 1/2 years from the date of manufacture by CSPD. Shelf-life is 2 years from date of manufacture by CSPD

Cooley Sign & Awning Products

Cooley-Brite® and Coolthane® are registered trademarks of Cooley, Inc.

Dickson® North American Collection

10-Year

LIMITED WARRANTY TERMS & CONDITIONS

DICKSON NORTH AMERICAN COLLECTION 10-YEAR LIMITED WARRANTY

Dickson warrants the rot-proof properties and color fastness (7/8 minimum color fastness under exposure to ultra-violet rays and bad weather conditions, according to the NF EN ISO 105 B02 and NF EN ISO 105 B04 standards) of its DICKSON NORTH AMERICAN COLLECTION fabrics for 10 years (starting from the date on which the awning is purchased).

This warranty is valid under the following terms and conditions:

- For 8 years, Dickson shall either replace free of charge or, at its convenience, reimburse the invoice value of the section of fabric recognized as faulty, excluding any costs or any other compensation for any reason whatsoever.
- In the event of a justified complaint after the 8th year, the warranty will consist of a discount on the purchase of a new fabric: 30% during the 9th year and 15% during the 10th year, at the rate applicable on the day of the complaint.
- Any complaint must be sent within ten days of the defect being noticed, accompanied by the purchase invoice, via registered mail with confirmation of receipt to: Dickson – Customer Service – BP 109 – 59443 Wasquehal Cedex France.
- The fabric must be kept available to the experts of Dickson or its insurance company.
- Replacement or reimbursement of the defective fabric does not extend the duration of the original warranty.

This warranty does not cover:

- The benefits not performed by Dickson: sewing of the fabric, etc.
- Parts of the awning other than the fabric manufactured by Dickson: valance, frame, etc.
- Imperfections such as mottling, waffling, folds, etc. due to handling during preparation of the awning or its installation
- Defects due to the aging and normal wear of the fabric
- The consequences of the conditions of installation, the environment or the use not corresponding to the normal conditions, uses of the profession, standards prescribed by Dickson or the destined use of the fabric
- The repair of damage or defects in the fabric resulting from accidents or negligence not attributable to Dickson or resulting from force majeure.

Expressly excluded in particular is any deterioration due to:

- Faulty maintenance or the use of unsuitable products or instruments: no detergent, chemical product or solvent can be used, nor any scraper or other

- instrument that may damage the surface
- Lightning or other unusual weather conditions
- Atmospheric or phytosanitary pollution
- Soiling caused by animals
- Faulty assembly or handling by the user, the projection of various products, hanging objects on the fabric, falling objects, bumps, road accidents, vandalism, burns from cigarettes or other sources, fire.

This limited warranty shall under no circumstances pose an obstacle to the legal guarantees.

Dickson

Dickson® is a registered trademark of Glen Raven, Inc.

Eradi-Lite®

8-Year (5-Year U.S. Desert Southwest1)

Eradi-Lite is warranted for eight years against loss of color under the following conditions: 1

- The awning must be properly installed, utilized and maintained. The warranty does not apply against deteriorations of any kind due to abusive use, negligence, vandalism, perforations, or acts of God.
- While all color pigmentations fade eventually, Eradi-Lite color fastness is guaranteed to remain within the standards set under normal conditions of exposure and atmospheric chemical pollution for a period of eight years from the date of the original installation.
- Normal wear, weather soiling, or stains from environmental pollution or other sources are not covered.
- The warranty, if applicable, is limited to the replacement of the fabric free of charge. Frames, systems, decorations, or labor are not covered by this warranty.
- TRIVANTAGE® MAKES NO WARRANTY OF FITNESS FOR ANY PARTICULAR PURPOSES WHATSOEVER WITH RESPECT TO THE GOODS BEING SOLD.
- THERE ARE NO WARRANTIES, EXPRESS OR IMPLIED, WHICH EXTEND BEYOND THE DESCRIPTION ON THE FACE OF THIS AGREEMENT.
- If within the first 60 months of the warranty period Eradi-Lite fades or undergoes excessive color degradation as described above, Trivantage will supply to the fabricator sufficient Eradi-Lite material to produce a new duplicate awning at no charge. If during the last 36 months of the warranty period Eradi-Lite fades or undergoes excessive color degradation as described above, Trivantage will supply to the fabricator sufficient Eradi-Lite material to produce a new duplicate awning at the then current price, and will grant an allowance equal to 1/96th of the original purchase price for each month remaining in the eight year warranted period of use.2
- This warranty gives you specific legal rights and you may also have other rights, which vary state to state.
- All claims shall be filed by the fabricator of the awning, through the company that sold Eradi-Lite to the fabricator.

1- Eradi-Lite is limited to a five year warranty in the Desert Southwest as defined by the following states and counties:

Arizona: All (entire state)

California: Imperial, Inyo, Mono, Riverside, San Bernardino

Nevada: Clark (Las Vegas), Esmeralda, Lincoln, Mineral, Nye

New Mexico: All (entire state)

Texas: Brewster, Culberson, El Paso, Hudspeth, Jeff Davis, Loving, Pecos, Presidio, Reeves, Ward, Winkler

Utah: Kane, Washington

2- New eight-year warranty applies to awning projects installed after October 26, 2005.

Trivantage, LLC

Eradi-Lite® is a registered trademark of Glen Raven, Inc.

FIRESIST®

5-Year

This limited warranty is valid only if a copy of the invoice for the item purchased is submitted showing the date of original purchase.

What is covered? This limited warranty covers the fabric becoming unserviceable because of loss of color or strength from normal usage and exposure conditions, including sunlight, mildew and atmospheric chemicals. Consumer is responsible for normal care and cleaning of the fabric. This warranty covers fabric only. Glen Raven's liability is expressly limited to this warranty.

How long is the coverage period? FIRESIST limited warranty coverage runs for five years (60 months) from the date of original installation.

What will Glen Raven do? Glen Raven will grant an allowance equal to 1/60th the original purchase price for each month remaining in the five year warranty period towards the purchase of all fabric required to produce a new duplicate awning.

How can you get service? Call the dealer or retailer from whom you purchased the product, to inspect the claim. They, in turn, will contact the manufacturer of the item purchased. The manufacturer will then contact Glen Raven and secure replacement fabric for you.

Glen Raven Custom Fabrics, LLC

FIRESIST® is a registered trademark of Glen Raven, Inc.

Harbor-Time®

5-Year

Harbor-Time®, a registered trademark of Glen Raven, Inc, is warranted for a period of five years from the date of the original installation against excessive loss of color or strength from normal exposure conditions including sunlight, mildew, rot and normal atmospheric chemicals which may render the fabric unserviceable. This warranty does not cover damage from Acts of God, vandalism, neglect or improper use.

In the unlikely event of fabric failure during the warranty period, Graniteville Specialty Fabrics will supply you, the end consumer, new fabric free of charge working through Trivantage and your dealer. Labor and installation are not covered by this warranty. Graniteville Specialty Fabrics reserves the right to inspect the fabric or made up item of any warranty claim.

Except for the explicit warranties, herein, no other warranty, expressed or implied, including any implied warranty of merchantability of fitness for a particular use is made by Graniteville Specialty Fabrics. In no event shall Graniteville Specialty Fabrics be liable for damages to any person or property, or any consequential or incidental damages.

Some states do not allow limitations on how long an implied warranty lasts or the exclusion or limitation of consequential or incidental damage, so, the above limitation or exclusion may not apply to you. This warranty gives you specific legal rights and you may have other rights which vary from state to state.

To get service, call the dealer from whom you purchased the product. The dealer will inspect the installation and process the claim through Trivantage, LLC and Graniteville Specialty Fabrics.

Graniteville Specialty Fabrics

Harbor-Time® is a registered trademark of Glen Raven, Inc.

Herculite® Excel M Series™

8-Year

8-Year Limited Warranty

Herculite® Excel M Series™ Awning Fabrics are guaranteed for a period of eight (8) years from date of original installation against rot or excessive deterioration, mildew stains, excessive loss of strength or color change if they occur in normal use and exposure, including sunlight and normal atmospheric chemicals. (Some color change is unavoidable due to ultraviolet rays and chemicals in the atmosphere).

In the unlikely event of failure of fabric during the eight (8) year period from date of original installation, Herculite Products Inc. will guarantee 100% replacement of the fabric to the original owner of the awning for the first five (5) years. Coverage is pro-rated for the three (3) year remainder of the warranty with a credit of 1/96th being applied toward the purchase of replacement material for each month remaining on the warranty. Herculite's liability will be limited to the replacement of the fabric only and does not cover labor, installation or graphic decorations.

This warranty protects you against damage to the fabric accessories used under normal conditions. It does not cover damage to the fabric from acts of God, vandalism, neglect or improper use. This warranty requires that the user implement proper care and maintenance as defined within Excel M Series, Handling and Maintenance Instructions.

This warranty is in lieu of all warranties expressed or implied, and, Herculite Products Inc. will not be liable for any consequential or incidental damage. Any implied warranties imposed by law are limited in time to the duration of the expressed warranty.

Some states do not allow limitations on how long an implied warranty lasts or the exclusion or limitation of incidental or consequential damage, so, the above limitation or exclusion may not apply to you. This warranty gives you specific legal rights and you may also have other rights which vary from state to state.

Herculite Products Inc.

Excel Series M™ is a trademark of Herculite Products Inc.
Herculite is registered trademark of Herculite Products Inc.

Herculite® Natura™

8-Year

8-Year Limited Warranty

Herculite® Natura™ Awning Fabrics are guaranteed for a period of eight (8) years from date of original installation against rot or excessive deterioration, mildew stains, excessive loss of strength or color change if they occur in normal use and exposure, including sunlight and normal atmospheric chemicals. (Some color change is unavoidable due to ultraviolet rays and chemicals in the atmosphere).

In the unlikely event of failure of fabric during the eight (8) year period from date of original installation, Herculite Products Inc. will guarantee 100% replacement of the fabric to the original owner of the awning for the first five (5) years. Coverage is prorated for the three (3) year remainder of the warranty with a credit of 1/96th being applied toward the purchase of replacement material for each month remaining on the warranty. Herculite's liability will be limited to the replacement of the fabric only and does not cover labor, installation or decorations.

This warranty protects you against damage to the fabric accessories used under normal conditions. It does not cover damage to the fabric from acts of God, vandalism, neglect or improper use. This warranty requires that the user implement proper care and maintenance as defined within Natura, Handling and Maintenance Instructions.

This warranty is in lieu of all warranties expressed or implied, and, Herculite Products Inc. will not be liable for any consequential or incidental damage. Any implied warranties imposed by law are limited in time to the duration of the expressed warranty.

Some states do not allow limitations on how long an implied warranty lasts or the exclusion or limitation of incidental or consequential damage, so, the above limitation or exclusion may not apply to you. This warranty gives you specific legal rights and you may also have other rights, which vary from state to state.

Herculite Products Inc.
Natura™ is a trademark of Herculite Products Inc.
 Herculite® is a registered trademark of Herculite Products Inc.

Herculite® Riviera Marine Fabric™

5-Year

Limited Warranty

Herculite® Riviera Marine Fabrics are guaranteed for a period of five (5) years from date of original installation against rot or excessive deterioration, mildew stains, excessive loss of strength or color change if they occur in normal use and exposure, including sunlight and normal atmospheric chemicals. (Some color change is unavoidable due to ultraviolet rays and chemicals in the atmosphere.)

In the unlikely event of failure of fabric during the five (5) year period from date of original installation, we will supply you, the original owner or the provider of your protective fabric accessories with replacement fabric at no charge.

This warranty protects you against damage to the fabric accessories used under normal conditions. It does not cover damage to the fabric from acts of God, vandalism, neglect or improper use.

This warranty is in lieu of all warranties expressed or implied, and, Herculite Products Inc. will not be liable for any consequential or incidental damage. Any implied warranties imposed by law are limited in time to the duration of the expressed warranty.

Some states do not allow limitations on how long an implied warranty lasts or the exclusion or limitation of incidental or consequential damage, so, the above limitation or exclusion may not apply to you. This warranty gives you specific legal rights and you may also have other rights, which vary from state to state.

Herculite Products Inc.
Riviera Marine Fabric™ is a trademark of Herculite Products Inc.
 Herculite® is a registered trademark of Herculite Products Inc.

Main Street® +

5-Year

Limited Warranty

Main Street®+, a registered trademark of Glen Raven, Inc, is warranted for a period of five years from the date of the original installation against excessive loss of color or strength from normal exposure conditions including sunlight, mildew, rot and normal atmospheric chemicals which may render the fabric unserviceable. This warranty does not cover damage from Acts of God, vandalism, neglect or improper use.

In the unlikely event of fabric failure during the warranty period, Graniteville Specialty Fabrics will supply you, the end consumer, new fabric free of charge working through Trivantage and your dealer. Labor and installation are not covered by this warranty. Graniteville Specialty Fabrics reserves the right to inspect the fabric or made up item of any warranty claim.

Except for the explicit warranties, herein, no other warranty, expressed or implied, including any implied warranty of merchantability of fitness for a particular use is made by Graniteville Specialty Fabrics. In no event shall Graniteville Specialty Fabrics be liable for damages to any person or property, or any consequential or incidental damages.

Some states do not allow limitations on how long an implied warranty lasts or the exclusion or limitation of consequential or incidental damage, so, the above limitation or exclusion may not apply to you. This warranty gives you specific legal rights and you may have other rights which vary from state to state.

To get service, call the dealer from whom you purchased the product. The dealer will inspect the installation and process the claim through Trivantage, LLC and Graniteville Specialty Fabrics.

Graniteville Specialty Fabrics
Main Street®+ is a registered trademark of Glen Raven, Inc.

Nassimi Breeze Vinyl Upholstery

3-Year

Nassimi LLC warrants our upholstery material products will be free from defects in material and workmanship under normal use for a period of 3 years from date of original purchase, as set forth herein.

In the event that our upholstery product does not perform to the specified performance standards when used for an intended application of the material, Nassimi LLC will offer replacement material free of charge.

For the warranty to go into effect Nassimi LLC requires that a sample of the material in question be returned to Nassimi LLC for inspection to determine that the product has:

- Been properly installed and not in a manner that puts excessive stress on any part of the material.
- Been properly maintained and has been cleaned using appropriate cleaning agents and methods as outlined on the back of the product card.
- Not been intentionally damaged, such as (but no limited to) tearing or puncturing.
- Not been post treated by the customer (such as but not limited to flame or adhesive lamination or chemical treatment after shipment by Nassimi LLC).
- Been upholstered in conjunction with proper foam cushioning under the material.
- Not been exposed to external contaminants or dyes that may have transferred to material.

If the product failure is determined to be from one of the aforementioned reasons the warranty is null and void. In the event that the product is determined by Nassimi to be defective during year one or two of this warranty Nassimi LLC will offer replacement product and additional support for labor not to exceed \$20/yd. for the amount of yardage used on the project offered in the form of a credit memo. During year three of this warranty Nassimi LLC will supply replacement product but will not be responsible for labor or other costs.

Nassimi LLC

Nautolex® Capitano Marine Vinyl Upholstery, SofDura and Voyager®

5-Year

Marine Upholstery Products for OEM

Limited Five Year Warranty

Subject to the limitations and conditions described below, OMNOVA Solutions Inc. warrants to its customers who are manufacturers of boats, seats or trim component parts ("Customers") that OMNOVA will replace Nautolex® marine upholstery products, topping and trim ("Product") if they fail during normal use due to defects in materials or workmanship during the period of five years from a Customer's retail sale of a boat, seat or completed trim component part containing product.

During the first three (3) years of this warranty, OMNOVA will replace defective Product and pay competitive labor rates for reupholstery of the seat and/or trim, with a limit of twenty dollars per linear yard of Product. During the fourth and fifth years, OMNOVA will supply replacement product, but will not pay for labor or other costs. THE REMEDY DESCRIBED IN THIS PARAGRAPH IS THE SOLE AND EXCLUSIVE REMEDY FOR DEFECTS IN NAUTOLEX PRODUCTS. IN NO EVENT SHALL OMNOVA HAVE ANY LIABILITY FOR ANY LOST PROFITS OR INDIRECT, INCIDENTAL, CONSEQUENTIAL, SPECIAL, PUNITIVE, OR EXEMPLARY DAMAGES, EVEN IF OMNOVA HAS BEEN ADVISED OF THE POSSIBILITY OF SUCH DAMAGES, INCLUDING BUT NOT LIMITED TO ANY DAMAGES ARISING FROM OR RELATING TO ANY INJURY TO PERSONS; LOSS OF VALUE OR USE (INCLUDING WITHOUT LIMITATION, DIMINUTION IN VALUE); DAMAGE TO OR LOSS OF OTHER PROPERTY; CLAIMS MADE BY END-USERS; OR COST OF SUBSTITUTE MATERIALS.

This warranty specifically excludes (a) staining resulting from mildew growth on adjacent boat components, bleeding from adjacent boat components or contact with suntan lotion; (b) degradation due to the presence of amines in adjacent urethane foam cushioning; (c) damage caused by improper installation or failure of the seat and/or trim parts; and (d) deterioration due to the use of improper cleaning materials or procedures.

OMNOVA MAKES NO OTHER WARRANTY, EXPRESSED OR IMPLIED, INCLUDING ANY WARRANTY OF MERCHANTABILITY OR FITNESS FOR PARTICULAR PURPOSE.

OMNOVA Solutions, Inc.

Nautolex® and Voyager® are registered trademarks of OMNOVA Solutions, Inc.

Nautolex® Marine Flooring

3-Year

3-Year Limited Warranty

Subject to the limitations and conditions described below, OMNOVA

Solutions Inc. warrants to its customers who are manufacturers of boats ("Customers") that OMNOVA will replace Nautolex® marine flooring products ("Product") if such products fail during normal use due to defects in materials or workmanship during the period of thirty six (36) months from the first retail sale of a boat containing such flooring as original equipment. This warranty extends only to customers who are manufacturers of boats.

If Product fails to meet this warranty, OMNOVA will replace defective

Product and pay competitive labor rates for re-installation of the Product, with a limit of twenty dollars per linear yard of Product. THE REMEDY DESCRIBED IN THIS PARAGRAPH IS THE SOLE AND EXCLUSIVE REMEDY FOR DEFECTS IN NAUTOLEX PRODUCTS. Under no circumstances shall OMNOVA be liable for incidental or consequential damages.

This warranty specifically excludes (a) damage caused by abrasive elements; (b) damage caused by improper installation; (c) damage or deterioration due to the use of improper cleaning materials or procedures; and (d) damage caused by adhesives.

OMNOVA MAKES NO OTHER WARRANTY, EXPRESSED OR IMPLIED, INCLUDING ANY WARRANTY OF MERCHANTABILITY OR FITNESS FOR PARTICULAR PURPOSE.

OMNOVA Solutions, Inc.

Nautolex® is a registered trademark of OMNOVA Solutions Inc.

Nite-Lite®

8-Year

Nite-Lite® is warranted against rot, mildew, and loss of color or strength under the following conditions:

- The fabric must be properly installed, utilized and maintained. The warranty does not apply against deteriorations of any kind due to abusive use, malfunction, negligence, vandalism, accidental burns, perforations, or acts of God.
- While all color pigmentations fade eventually, Nite-Lite color fastness is guaranteed to remain within the standards set under normal conditions of exposure and atmospheric chemical pollution for the specified warranty period from the date of the original installation.
- Normal wear, weather soiling, or stains from environmental pollution or other sources are not covered.
- The warranty, if applicable, is limited to the replacement of the fabric free of charge for eight years from the date of the original installation. Years six through eight are covered on a pro-rated basis. Fabricator will be credited a percentage of the purchase price of the fabric equal to the number of months left in the warranty divided by 36 (example: 18 months left divided by 36 equals 50%, therefore, 50% credit). Frames, systems, graphic applications, or labor are not covered by this warranty.
- TRIVANTAGE® MAKES NO WARRANTY OF FITNESS FOR ANY PARTICULAR PURPOSES WHATSOEVER WITH RESPECT TO THE GOODS BEING SOLD.
- THERE ARE NO WARRANTIES, EXPRESS OR IMPLIED, WHICH EXTEND BEYOND THE DESCRIPTION ON THE FACE OF THIS AGREEMENT.
- This warranty gives you specific legal rights and you may also have other rights which vary state to state.

Trivantage, LLC

Nite-Lite® is a registered trademark of Glen Raven, Inc.

Patio 500®

5-Year (excluding pattern 513 Clear)

Limited Warranty

Patio 500® Awning Fabrics are warranted for a period of five (5) years from date of original installation against rot or excessive deterioration, excessive loss of strength or color change if they occur in normal use and exposure, including sunlight and normal atmospheric chemicals. (Some color change is unavoidable due to ultraviolet rays and chemicals in the atmosphere.)

In the unlikely event of failure of fabric during the five (5) year period from date of original installation, we will supply you, the original owner or the provider of your protective fabric accessories with replacement fabric at no charge.

This warranty protects you against damage to the fabric accessories used under normal conditions. It does not cover damage to the fabric from acts of God, vandalism, neglect or improper use.

This warranty is in lieu of all warranties expressed or implied, and, Herculite Products Inc. will not be liable for any consequential or incidental damage. Any implied warranties imposed by law are limited in time to the duration of the expressed warranty.

Some states do not allow limitations on how long an implied warranty lasts or the exclusion or limitation of incidental or consequential damage, so, the above limitation or exclusion may not apply to you. This warranty gives you specific legal rights and you may also have other rights, which vary from state to state.

Herculite Products Inc.
 Patio 500® is a registered trademark of Herculite Products Inc.

Phifertex®

3-Year

Limited Warranty

What Is Covered?

This warranty covers the fabric becoming non-functional because of loss of dimensional stability from exposure conditions including sunlight, mildew, rot and normal atmospheric conditions. Abnormal or excessive discoloration and fading is covered. It does not cover discoloration from atmospheric pollution or other debris.

How Long Is The Coverage Period?

The warranty coverage runs for 3 years from the date of purchase.

What Will Phifer Do?

Phifer Incorporated will provide new fabric, free, to replace the non-functioning fabric. This warranty does not cover the cost of labor or other consequential or incidental expenses.

How Can You Get Service?

Contact the merchant from whom you purchased the product. The merchant will contact Phifer.

Phifer Inc.
 Phifertex® is a registered trademark of Phifer Inc.

Polytex®

10-Year Against UV Degradation

UV PERFORMANCE WARRANTY FOR POLYTEX®

POLYTEX® and COMTEX® EXTRA HEAVY DUTY KNITTED SHADECLOTH ("fabric") are premium fabrics designed for use in shade structures and shade sails.

Warranty

Polyfab USA LLC ("Polyfab") warrants to the initial purchaser that the fabric will not suffer from abnormal deterioration from ultra violet exposure for a period of 10 years from the date of installation. The term abnormal deterioration means the fabric has mechanically failed during the actual application in the shading environment intended for such fabric. Such abnormal deterioration is defined by a measure of loss of tensile and tear strength (both in warp and weft direction) that is greater than 5% per annum; if such degradation of tensile strength has been caused by ultra violet radiation and the chemical processes that ultra violet radiation initiates in the plastics and the additives alone. The maximum working load of the fabric should not exceed 60% of the break strength in both warp and weft directions. This warranty does not include normal fading or wear and tear.

Fading, by itself, is not an indication of loss of strength due to ultra violet radiation. If the fabric does suffer from abnormal deterioration during the 10-year warranty period, Polyfab will, at its option either replace the fabric or supply equivalent fabric, or pay the cost of replacing the fabric or of acquiring equivalent fabric.

POLYFAB UNDERTAKES NO RESPONSIBILITY FOR THE QUALITY OF THE FABRIC EXCEPT AS OTHERWISE PROVIDED HEREIN. THERE IS NO IMPLIED WARRANTY THAT THE FABRIC SHALL BE MERCHANTABLE. POLYFAB ASSUMES NO RESPONSIBILITY THAT THE FABRIC WILL BE FIT FOR ANY PARTICULAR PURPOSE FOR WHICH YOU MAY BE BUYING THE FABRIC, EXCEPT AS OTHERWISE PROVIDED HEREIN. THERE IS NO IMPLIED WARRANTY THAT THE FABRIC SHALL BE FIT FOR ANY PARTICULAR PURPOSE. YOU ACKNOWLEDGE THAT YOU ARE NOT RELYING ON POLYFAB'S SKILL OR JUDGMENT TO SELECT OR FURNISH THE FABRIC SUITABLE FOR ANY PARTICULAR PURPOSE AND THAT THERE IS NO WARRANTY, WHICH EXTENDS BEYOND THAT PROVIDED HEREIN.

Exclusions

This warranty does not cover, and Polyfab is not liable for, deterioration of fabric occurring due to any of the following circumstances:

- Exposure to pollution, chemicals, solvents, cleaning agents or other substances that are harmful to the performance of the fabric.
- Faulty installation of the fabric or faulty design or manufacture of any structure to which the fabric is attached.
- Improper storing, handling, bracing, use of the fabric or use contrary to the specifications for the fabric.
- Color fading or variation due to ultraviolet exposure.
- Minor color variation from fabric samples.
- Minor visual imperfection due to the manufacturing processes.
- The negligent act or omission of any person.
- Misuse, neglect or abuse of the fabric.

Limitation of Liability

Polyfab's obligations and liabilities are expressly and exclusively limited to those set forth herein. POLYFAB SHALL NOT BE LIABLE FOR DIRECT, INDIRECT, INCIDENTAL, CONSEQUENTIAL, OR SPECIAL DAMAGES, INCLUDING LOSS OF PROFITS, OR OTHER COMMERCIAL LOSS, AND INCLUDING CLAIMS BASED ON NEGLIGENCE OR STRICT LIABILITY, EXCEPT AS OTHERWISE PROVIDED FOR HEREIN. NOTWITHSTANDING THE FOREGOING, ANY LIABILITY RELATED TO THE FABRIC SHALL BE LIMITED TO THE PURCHASE PRICE OF THE FABRIC.

Claims Procedure

All claims must be made in writing, within 30 days from the date upon which the defect became known, to Polyfab USA LLC, 1601 N. Sepulveda Blvd. #392, Manhattan Beach, CA 90266. Claims must be supported by a sample of the defective fabric together with proof purchase, including the date and location of fabric purchase.

POLYFAB AUSTRALIA Pty. Ltd.
 Comtex® and Polytex® are registered trademarks of Polyfab USA LLC.

Sea-Spraé®

3-Year

Sea-Spraé, a registered trademark of Glen Raven, Inc, is warranted for a period of three years from the date of the original installation against excessive loss of color or strength from normal exposure conditions including sunlight, mildew, rot and normal atmospheric chemicals which may render the fabric unserviceable. This warranty does not cover damage from Acts of God, vandalism, neglect or improper use.

In the unlikely event of fabric failure during the warranty period, Graniteville Specialty Fabrics will supply you, the end consumer, new fabric free of charge working through Trivantage and your dealer. Labor and installation are not covered by this warranty. Graniteville Specialty Fabrics reserves the right to inspect the fabric or made up item of any warranty claim.

Except for the explicit warranties, herein, no other warranty, expressed or implied, including any implied warranty of merchantability of fitness for a particular use is made by Graniteville Specialty Fabrics. In no event shall Graniteville Specialty Fabrics be liable for damages to any person or property, or any consequential or incidental damages.

Some states do not allow limitations on how long an implied warranty lasts or the exclusion or limitation of consequential or incidental damage, so, the above limitation or exclusion may not apply to you. This warranty gives you specific legal rights and you may have other rights which vary from state to state.

To get service, call the dealer from whom you purchased the product. The dealer will inspect the installation and process the claim through Trivantage, LLC and Graniteville Specialty Fabrics.

Graniteville Specialty Fabrics

Sea-Spraé® is a registered trademark of Glen Raven, Inc.

SeaMark™

5-Year

Limited Warranty

SeaMark™ carries the Sunbrella® fabric limited five-year warranty. This warranty covers the face fabric becoming unserviceable because of loss of color or strength from normal exposure to conditions including sunlight, mildew, rot and atmospheric chemicals. It does not cover labor and installation supplied by the dealer.

Care and Cleaning

Although the fabric does not promote mildew growth by itself, mildew may develop on dirt and other foreign substances that are not removed. This is especially true in warm, humid, dark environments. A program of keeping the fabric clean through regular washings, BEFORE it gets dirty, will enhance the life and beauty of the acrylic and make successive cleaning easier.

Haartz Corporation recommends using Bimini Topp™ Marine Cleaner and Bimini Topp™ Marine Protectant. (Available from Wolfsteins Pro-Series at www.wolfsteins.com.)

Hand washing in shade or partial shade, not direct sunlight, is best. DO NOT USE DETERGENT. Bird and tree droppings, as well as other loose particle soilage, should be removed immediately. Vacuum with a brush attachment and rinse thoroughly with water to remove loose particle soils. This will also prevent the soils from being redeposited during the cleaning process. Once the fabric has been rinsed thoroughly, spray Bimini Topp™ Marine Cleaner evenly over the entire surface while still wet. Allow the cleaner to soak for 10 to 20 minutes and then scrub lightly with a soft nylon brush or terry cloth rag. Rinse thoroughly, preferably until no remaining soap foam is observed. Additional

cleanings may be required. It is best to determine the need for additional cleanings after the fabric has dried completely.

Once dry, cleaning must be followed by re-water repelling with Bimini

Topp™ Marine Protectant. (This product does not contain CFCs and therefore, is not harmful to the environment.) Failure to apply will result in rapid resoiling of the unprotected fabric. Washing with soap (i.e. Ivory or Lux) and warm water is a safe alternative to Bimini Topp™ Marine Cleaner, but not as effective.

For more stubborn cases, mix a solution of no more than 1/2 cup (4 oz.) bleach and 1/4 cup (2 oz.) Bimini Topp™ Marine Cleaner per gallon of water, soak for approximately 20 minutes and scrub lightly as indicated above. (Excessive soaking with the bleach solution can deteriorate seam threads.) Rinse thoroughly to prevent streaking on painted and chrome surfaces. Several cleanings may be necessary. Once again, Bimini Topp™ Marine Protectant water repellent must be applied to the fully dried fabric.

The Haartz Corporation

SeaMark™ is a trademark of the Haartz Corporation
Sunbrella® is a registered trademark of Glen Raven, Inc.

Serge Ferrari Précontraint® 502 Satin

10-Year

10-Year Limited Warranty

Applications: awnings and fixed shading systems

Manufactured according to the Serge Ferrari Technology and benefiting from the ISO 9001 Quality Assurance system, composite materials are guaranteed for 10 years for the mentioned applications.

1) Warranty

Are guaranteed against any abnormal degradation of their main characteristics as part of normal use:

- breaking strength at least 30% of its original value,
- uniform colour change over time, for the same orientation and exposure,
- fire resistance as specified in the original technical document,
- impermeability.

2) Warranty application conditions

The warranty takes effect on the day of delivery of the membranes to the customer.

In the event of proven liability, the warrantor declares its readiness to reimburse all or part of the costs of repair or replacement, subject to the conditions set forth in the table below. The percentage contribution of the warrantor shall take into account the warranty limits stated below, the installation conditions for the product and its exposure time.

The right to warranty only applies if the imperfections are reported by registered letter with acknowledgment of receipt to Serge Ferrari within a maximum time period of 30 calendar days of their occurrence; the invoice of the goods must also have been fully paid. A product purchase receipt shall be required in support of any claim. The sum reimbursed by the warrantor shall not exceed the initial purchase price paid by the first acquirer.

The costs of repair or replacement not covered by the warrantor following reimbursement shall remain payable by the third party.

This warranty does not therefore cover the labour costs or those resulting from the disassembling, reassembling and transportation operations. Furthermore, no monetary compensation is provided for under the terms of this warranty.

The sum covered by the warrantor shall be proportional to the number of years between the start of exposure and the appearance of the defect:

PERCENTAGE OF FERRARI LIABILITY

Defect Occurring In	Percentage of Cost Assumed by Ferrari	Defect Occurring In	Percentage of Cost Assumed by Ferrari
1st Year	100%	5th Year	41%
2nd Year	80%	6th Year	33%
3rd Year	64%	7th Year	26%
4th Year	51%	8th Year	20%

3) Exclusions

Liability under the warranty is excluded, if damage results from:

- Non-compliance with installation recommendations and directions issued by the warrantor.
- Lack of fabric tension (for example slack, skewness) and installation on a retractable system. Précontraint 502 Satin material must remain faultlessly tensioned.
- Tear or repair during installation.
- Improper usage, negligence, product alterations, accidental damage of external covering, premature wear, rubbing, scratching, perforation exceeding normal wear.
- Exposure to chemicals, damage caused by machinery, devices or persons, excessive pressure, exceptional meteorological conditions, falling objects, explosions, fire, flooding, rioting, civil unrest, war, resorting to violence, faulty installation or improper implementation, radiation, aggressive vapour or dust in suspension.
- Damage during storage or installation by installer or final customer, exposure to heavy air pollution, cleaning with over-aggressive or unsuitable products.
- Application to or within structures non-compliant with construction standards applicable at the installation location, repairs or alterations causing loss of product performance performed by a person unauthorized by the warrantor.
- Any operation subsequent to material delivery, such as printing (notwithstanding the method used), welding or thermo-gluing of additional parts or fabrics.

On declaration of the defect referred to, the warrantor reserves the right to inspect and test the implicated product to determine the measures to be taken to remedy the defect. The warrantor, moreover, refuses any liability under the warranty, if the third party breaches the right of the representatives of the warrantor to examine the defect referred to.

4) Limitations

This warranty is limited and applies exclusively to the specified product and intended usage. It replaces all previous promises or warranties, either explicit or tacit, written or oral.

The warrantor refuses any liability regarding installation of mediocre quality or application not conforming with product specific characteristics.

With regard to services under warranty, any possible claims concerning products and the liability of the warrantor shall be exclusively governed by these terms and conditions of limited warranty. The third party accepts the present warranty clauses and certifies that no warranty or promise of warranty, other than the present clauses, has been concluded or foreseen with regard to the products or accessories supplied by the warrantor.

5) Limitations of liability

The warrantor cannot be held liable for losses of income, commercial or operational losses, financial charges or any other specific, consequential, circumstantial or mediate loss of any kind, possessing a causal link to, or related to, the products covered by this warranty, their implementation or usage, or the impossibility of using the said products or their late delivery. The warrantor shall decide at its convenience on the measures to be taken, if the liability of the warrantor is recognized, within the limits of the aforementioned provisions with regard to repair, defect elimination or product replacement.

Costs of replacement shall not be reimbursed.

6) Final conditions

The competent jurisdiction governing any dispute resulting from the terms and conditions of this warranty shall be that of the registered office of the warrantor (Bourgoin-Jallieu, 38 France). This warranty agreement is governed by French law.

All questions or actions in warranty relating to the limited warranty defined above shall be addressed to:

Serge Ferrari sas
B.P. 54
38352 La Tour du Pin Cedex
France

Ensure you have the document valid on the project date before activating the warranty Valid from the 01st of November 2015

The Serge Ferrari Group
Précontraint® is a registered trademark of The Serge Ferrari Group.

Serge Ferrari Soltis® 86 and 92

5-Year

5-Year Limited Warranty

Subject to all the terms and conditions contained herein and with specific reference to the percentage of Serge Ferrari Liability Chart contained herein, Tissage et Enduction Serge Ferrari S.A. ("Serge Ferrari") hereby provides a five (5) year limited warranty for the Ferrari architectural fabrics Précontraint® 502 and 702 (specification sheets here enclosed).

A) COMPLIANCE WITH SPECIFICATIONS – Serge Ferrari warrants that the products shall, at the time of delivery at Ferrari’s plant of manufacture, meet all technical specifications stated in the published Serge Ferrari data sheet.

B) TENSILE STRENGTH – Serge Ferrari warrants that the products shall retain at least 70% of their tensile strength for a period of five (5) years following delivery of the products by our authorized distributors.

C) FLAME RETARDANCY AND WATERPROOFING – Ferrari warrants that the products shall remain flame retardant and waterproof for a period of five (5) years following the delivery of the products by our authorized distributors.

Each of the above-described warranties is herein described collectively as the "LIMITED WARRANTY."

SERGE FERRARI’S OBLIGATIONS UNDER LIMITED WARRANTY: Serge Ferrari agrees to provide, to the extent and for the time period stated in the chart below, a percentage of the cost to repair or replace at Serge Ferrari’s sole option, the products which may provide defective or otherwise fail to perform as stated above under normal use, maintenance and service, as determined by Serge Ferrari during the warranty period (a "Defect" or "Defective Product"), not to exceed the original sales price to the original purchaser of the Product. The customer must pay the remaining portion of any such costs of repair or replacement of a Defective Product.

PERCENTAGE OF SERGE FERRARI LIABILITY

Defect Occurring In	Percentage of Cost Assumed by Serge Ferrari	Defect Occurring In	Percentage of Cost Assumed by Serge Ferrari
1st Year	100%	4th Year	51%
2nd Year	80%	5th Year	41%
3rd Year	64%	6th Year	0%

WARRANTY EXCLUSIONS: This Limited Warranty does not apply to any product or any part thereof that, in the sole judgment of Serge Ferrari, (1) has been subject to misuse, neglect, alteration or accident, such as accidental damage to the exterior finish, or which has been subject to excess wear and tear, friction, scratches or perforations which exceed normal use; (2) has been exposed to harmful chemicals, abused by machinery, equipment or any person, exposed to excessive pressures or sources, exposed to abnormal weather conditions, falling objects, explosions, fire, floods, riots, civil commotion, exterior forces, faulty or inadequate installation, acts of war, radiation, harmful fumes or foreign substances in the atmosphere; (3) has been damaged during handling by the customer or other user or consumer of the Products, or which has been subjected to high atmosphere pollution, aggressive detergents, and aggressive cleaning; or (4) has been used in architectural structures not in accordance with accepted engineering standards or repaired or altered by anyone other than Serge Ferrari in any way so as, in Serge Ferrari's sole judgment, to affect the quality, efficiency or effectiveness of the Products. Serge Ferrari does not warrant any applied graphics.

Any claim made by a user of the Products under this Limited Warranty shall be made in writing by registered mail with acknowledgment of receipt to Serge Ferrari at the address listed below no later than thirty (30) days following the discovery of the alleged Defect. Failure to notify Serge Ferrari within thirty (30) days following the discovery of any Defect shall render this Limited Warranty null, void and of no legal effect with respect to that particular Defect. After notification of an alleged Defect, Serge Ferrari shall be entitled to inspect the Product in order to take appropriate steps for timely corrective measures. In the event Serge Ferrari representatives are denied the right to inspect the alleged Defect, this Limited Warranty shall be null, void and of no legal effect with respect to such Defect.

LIMITATION OF WARRANTY: THIS LIMITED WARRANTY IS THE EXCLUSIVE WARRANTY WITH RESPECT TO THE PRODUCTS AND IS IN LIEU OF AND SUPERSEDES ALL OTHER REPRESENTATIONS OR WARRANTIES WHETHER WRITTEN OR ORAL, EXPRESSED OR IMPLIED. FERRARI EXPRESSLY DISCLAIMS ANY IMPLIED WARRANTIES OF MERCHANTABILITY OR FITNESS FOR A PARTICULAR PURPOSE. THE SOLE AND EXCLUSIVE REMEDIES OF ANY PERSON RELATING TO THE PRODUCTS, AND THE FULL LIABILITY OF FERRARI FOR ANY BREACH OF THIS WARRANTY, ARE THOSE PROVIDED IN THIS LIMITED WARRANTY. ANY USER OF THE PRODUCTS HEREBY AGREES AND ACKNOWLEDGES THAT NO OTHER WARRANTIES ARE OFFERED OR PROVIDED IN CONNECTION WITH OR FOR THE PRODUCTS OR ANY PART THEREOF.

EFFECTIVENESS OF WARRANTY: This Limited Warranty shall become effective upon the customer purchasing, receiving and paying for a warranted product. Should a warranty issue or claim be filed, the customer is under the obligation to provide the actual production batch number of the product appearing on the rolls and on the packing list to enable tracking of the material.

LIMITATION OF LIABILITY: Serge Ferrari shall not be liable for any loss of profits or revenue, loss of use of equipment or facility, cost of capital or for any other special, indirect, incidental or consequential damages of any nature resulting from or in any manner relating to the Products covered hereby, their design, use, any inability to use the same or any delay in the delivery of the same. THE SOLE AND EXCLUSIVE REMEDY WITH RESPECT TO ANY DEFECTIVE PRODUCTS SHALL BE THE REPAIR, CORRECTION OR REPLACEMENT THEREOF, PURSUANT TO THE FOREGOING PROVISIONS.

Should the Products prove so defective, however, as to preclude the remedying of warranted defects by repair or replacement, the customer's sole and exclusive remedy shall be the refund of the purchase price of the fabric, or part thereof which is defective, upon its return to Serge Ferrari.

The terms and provisions of this Limited Warranty shall be governed by, construed under and enforced in accordance with, the laws of France, without regard to Uniform United Nations Conventions.

Any questions, inquiries or claims under this Limited Warranty shall be directed to:

Tissage et Enduction Serge Ferrari S.A.
B.P. 54
38352 La Tour Du Pin Cedex
France

The Serge Ferrari Group
Soltis® is a registered trademark of The Serge Ferrari Group.

Serge Ferrari STAM 6002L

8-Year

8-Year Limited Warranty

Static and permanent awnings, canopies, shade sails subject to all the terms and conditions contained herein and with specific reference to the percentage of Serge Ferrari liability chart contained herein, Serge FERRARI («Ferrari») hereby provides a eight (8) year limited warranty for the product, STAM 6002L.

I. OBJECT OF THE WARRANTY

A) Compliance with specifications

Serge Ferrari warrants that the product shall at the time of delivery at Serge Ferrari's plant of manufacture, meet all technical specifications stated in the published Ferrari data sheets.

B) Compliance with sustainability & functionality requirements

Serge Ferrari warrants the sustainability & functionality of the concerned membrane. Given the current knowledge, mechanical or aesthetic changes cannot be avoided by use conditions or circumstances environment. The guarantee provided by Serge Ferrari could not be committed in this context and any legal action against it would be null and void.

C) Compliance with our commitments

In the event of default occurring and reported during the warranty period, under normal use and if it can be proved that the defect in the membrane decreases the performance and function of the article made, Serge Ferrari accepts the replacement at its expense the only defective material to the exclusion of any other involvement.

D) Flame retardancy and waterproofing

Serge Ferrari warrants that the products shall remain flame retardant and waterproof for a period of 8 (eight) years following the delivery of the product from Serge FERRARI plant of manufacture.

Each of the above described warranties are herein described collectively as the "Limited warranty".

II. DUTIES OF THE PARTIES

The warranty takes effect on the day of delivery of the Serge Ferrari membrane to the customer.

The right to warranty only applies if the imperfections are reported by registered letter with acknowledgment of receipt to Serge Ferrari within a maximum time period of 30 calendar days of their occurrence; the invoice of the goods must also have been fully paid.

Failure to notify Serge Ferrari within thirty (30) days following the discovery of any defect shall render this limited warranty null, void and of no legal effect with respect to that particular defect. After notification of an alleged defect, Serge Ferrari shall be entitled to inspect the product in order to take appropriate steps for timely corrective measures. In the event Serge Ferrari representatives are denied the right to inspect the alleged defect, this limited warranty shall be null, void and of no legal effect with respect to such defect.

In the event of proven liability, the warrantor declares its readiness to reimburse all or part of the costs of repair or replacement, subject to the conditions set forth in the table below.

The sum reimbursed by the warrantor shall not exceed the initial purchase price paid by the first acquirer.

The percentage contribution of the warrantor shall take into account the warranty limits stated below, the installation conditions for the product and its exposure time.

This warranty does not therefore cover the labour costs or those resulting from the disassembling, reassembling and transportation operations. Furthermore, no compensation is provided for under the terms of this warranty.

Under the guarantees described above, and subject to the exclusions hereafter, we will supply the necessary yardage to replace the project following a depreciation coefficient as described below.

PERCENTAGE OF FERRARI LIABILITY

Defect Occurring In	Percentage of Cost Assumed by Ferrari	Defect Occurring In	Percentage of Cost Assumed by Ferrari
1st Year	100%	5th Year	40%
2nd Year	80%	6th Year	35%
3rd Year	65%	7th Year	25%
4th Year	50%	8th Year	20%

III. WARRANTY EXCLUSIONS

This limited Warranty does not apply to any product or any part thereof that, in the sole judgment of Serge Ferrari,

(I) has been subject to misuse, neglect, alteration or accident, such as accidental damage to the exterior finish, or which has been subject to excess wear and tear, friction, scratches or perforations which exceed normal use;

(II) has been exposed to harmful chemicals, abused by machinery, equipment or any person, exposed to excessive pressures or sources, exposed to abnormal conditions, falling objects, explosions, fire, floods, riots, civil commotion, act of war, radiation, harmful fumes or foreign substances in the atmosphere;

(III) Has been submitted to exterior forces, faulty or inadequate installation that may lead to mechanical failures (i.e.: flapping and or creasing).

(IV) has been damaged during handling by the customer or other user or consumer of the Products, or which has been subjected to high atmosphere pollution, aggressive detergents, aggressive cleaning;

(V) has been used in architectural structures not in accordance with accepted engineering standards or repaired or altered by anyone other than Serge Ferrari in any way so as, in Serge Ferrari’s sole judgment, to affect the quality, efficiency or effectiveness of the Products;

(VI) has been misused and damaged by a non appropriate structure, defective fixing system during and after installation or confection.

Limitation of warranty: this limited warranty is the exclusive warranty with respect to the products and is in lieu of and supersedes all other representations or warranties, whether written or oral, express or implied. Serge Ferrari expressly disclaims any implied warranties of merchantability or fitness for a particular purpose. The sole and exclusive remedies of any person relating to the products, and the full liability of Serge Ferrari for any breach of this warranty, are those provided in this limited warranty. Other than as provided in this limited warranty, any user of the products hereby agrees and acknowledges that no other warranties are offered or provided in connection with or for the products or any part thereof.

IV. LIMITATIONS

This warranty is limited and applies exclusively to the specified product and intended usage. It replaces all previous promises or warranties, either explicit or tacit, written or oral.

The warrantor refuses any liability regarding installation of mediocre quality or application not conforming with product specific characteristics.

With regard to services under warranty, any possible claims concerning products and the liability of the warrantor shall be exclusively governed by these terms and conditions of limited warranty. The third party accepts the present warranty clauses and certifies that no warranty or promise of warranty, other than the present clauses, has been concluded or foreseen with regard to the products or accessories supplied by the warrantor.

V. LIMITATION OF LIABILITY

The warrantor cannot be held liable for losses of income, commercial or operational losses, financial charges or any other specific, consequential, circumstantial or mediate loss of any kind, possessing a causal link to, or related to, the products covered by this warranty, their implementation or usage, or the impossibility of using the said products or their late delivery.

The warrantor shall decide at its convenience on the measures to be taken, if the liability of the warrantor is recognized, within the limits of the aforementioned provisions with regard to repair, defect elimination or product replacement. Costs of replacement shall not be reimbursed.

Should the Products prove so defective, however as to preclude the remedying of warranted defects by repair or replacement, the customer’s sole and exclusive remedy shall be the refund of the purchase price of the fabric, or part thereof which is defective, upon its return to Serge Ferrari.

The terms and provisions of this Limited Warranty shall be governed by, construed under and enforced in accordance with, the laws of France, without regard to Uniform United Nations Conventions.

VI. FINAL CONDITIONS

The competent jurisdiction governing any dispute resulting from the terms and conditions of this warranty shall be that of the registered office of the warrantor (Bourgoin-Jallieu, 38 France). This warranty agreement is governed by French law.

All questions or actions in warranty relating to the limited warranty defined above shall be addressed to:

Serge Ferrari sas
 B.P. 54
 38352 La Tour du Pin Cedex
 France

Valid from the 15th of November 2015 - Ensure to possess valid warranty document at the time of project

The Serge Ferrari Group

SheerWeave® Exterior

5-Year Exterior

Extended Limited Warranty

What is Covered?

This warranty covers all colors of SheerWeave® Styles 1000, 2000, 2100, 2390, 2360, 2410, 2500, 2701, 2703, 2705, 2710, 3000, 4000, 4100, 4400, 4500, 4600, 4550, 4650, 4800 and 5000 when properly handled and installed for normal use in exterior systems. Phifer guarantees that, when delivered to our customer, Phifer SheerWeave will meet or exceed all of our specifications with regard to mesh configuration, dimension, strength and color. Phifer further guarantees that Phifer SheerWeave will not become nonfunctional because of changes in physical properties due to exposure to normal atmospheric conditions. This warranty does not cover damage to screen from any source nor does it cover gradual fading.

Any defects found with regard to mesh configuration, dimension, strength or color, that exist at the time of initial delivery, must be reported to Phifer within a reasonable period of time and before fabrication or installation of the material. Only full or partial rolls of Phifer SheerWeave may be returned to Phifer for replacement under this warranty except as provided in the following paragraph.

The Phifer SheerWeave mentioned above is covered by this warranty if the fabric becomes nonfunctional due to changes in physical properties. If the fabricated screen appears to be defective, it must be returned to Phifer without hardware or attachments to be inspected.

How Long Is The Coverage Period? The warranty against changes in physical properties is valid for a period of five (5) years.

What Will Phifer Do? Any Phifer SheerWeave found to be defective will be replaced, free of charge, with an equal quantity of Phifer SheerWeave fabric.

THIS WARRANTY DOES NOT COVER THE COST OF LABOR OR OTHER CONSEQUENTIAL EXPENSES RELATED TO REMOVAL, RETURN OR RE-INSTALLATION OF PHIFER SHEERWEAVE.

THIS IS THE COMPLETE AND ONLY WARRANTY PROVIDED FOR PHIFER SHEERWEAVE. THERE ARE NO OTHER WARRANTIES, EXPRESS OR IMPLIED, FOR THIS PRODUCT.

Phifer Inc.

SheerWeave® is a registered trademark of Phifer Inc.

SheerWeave® Interior

10-Year Interior

Extended Limited Warranty

What is Covered?

This warranty covers all styles of Phifer SheerWeave shading fabric when properly handled and installed for normal use as interior vertical window shading. Phifer guarantees that, when delivered to our customer, SheerWeave will meet or exceed all of our specifications with regard to mesh configuration, dimension, strength and color. Phifer further guarantees that SheerWeave will not become nonfunctional because of changes in physical properties due to exposure to normal atmospheric conditions. This warranty does not cover damage to the shading fabric from any source nor does it cover gradual fading.

Any defects found with regard to mesh configuration, dimension, strength or color, that exist at the time of initial delivery, must be reported to Phifer within a reasonable period of time and before fabrication or installation of the material. Only full or partial rolls of SheerWeave may be returned to Phifer for replacement under this warranty except as provided in the following paragraph.

Any SheerWeave fabric installed as a fabricated shade is covered by this warranty if the fabric becomes nonfunctional due to changes in physical properties. If the fabricated shade appears to be defective, it must be returned to Phifer without hardware or attachments to be inspected.

How Long Is The Coverage Period?

The warranty against changes in physical properties is valid for a period of ten (10) years.*

What Will Phifer Do?

Any SheerWeave found to be defective will be replaced, free of charge, with an equal quantity of SheerWeave fabric.

THIS WARRANTY DOES NOT COVER THE COST OF LABOR OR OTHER CONSEQUENTIAL EXPENSES RELATED TO REMOVAL, RETURN OR RE-INSTALLATION OF SHEERWEAVE FABRIC.

THIS IS THE COMPLETE AND ONLY WARRANTY PROVIDED FOR PHIFER SHEERWEAVE FABRIC. THERE ARE NO OTHER WARRANTIES, EXPRESS OR IMPLIED, FOR THIS PRODUCT.

*SheerWeave Infinity and Styles 7000, 7300, 7350 and 7500 carry a five (5) year warranty.

Phifer Inc.

SheerWeave® is a registered trademark of Phifer Inc.

Showtime® II

2-Year

Showtime® Event Fabrics are guaranteed for a period of two (2) years from date of original installation against rot or excessive deterioration, mildew stains, excessive loss of strength or color change if they occur in normal use and exposure, including sunlight and normal atmospheric chemicals. (Some color change is unavoidable due to ultraviolet rays and chemicals in the atmosphere.)

In the unlikely event of failure of fabric during the two (2) year period from date of original installation, we will supply you, the original owner or the provider of your protective fabric accessories with replacement fabric at no charge.

This warranty protects you against damage to the fabric accessories used under normal conditions. It does not cover damage to the fabric from acts of God, vandalism, neglect or improper use.

This warranty is in lieu of all warranties expressed or implied, and, Herculite Products Inc. will not be liable for any consequential or incidental damage. Any implied warranties imposed by law are limited in time to the duration of the expressed warranty.

Some states do not allow limitations on how long an implied warranty lasts or the exclusion or limitation of incidental or consequential damage, so, the above limitation or exclusion may not apply to you. This warranty gives you specific legal rights and you may also have other rights which vary from state to state.

Herculite Products Inc.

Showtime® and Herculite® are registered trademark of Herculite Products Inc.

Softouch™

3-Year

SOFTOUCH™ coated polyester fabric with non woven backer, when used properly, is guaranteed for a period of three (3) years from date of original installation against excessive loss of color or strength from normal exposure conditions, including sunlight, rot, or normal atmospheric chemicals which might render it unserviceable.

In the unlikely event of fabric failure during the three year period, Marlen Textiles will at its option, supply the original owner of the cover either fabric or credit of the original fabric value. This warranty does not cover labor, installation, or fabrication costs.

This warranty protects you against damage to covers used under normal conditions. It does not cover damage from Acts of God, vandalism, neglect or use or care not in accordance with Marlen Textiles' use and care instructions.

This warranty is in lieu of all warranties expressed or implied and Marlen Textiles will not be liable for any consequential or incidental damage. Any implied warranties imposed by law are limited in time to the duration of the expressed warranty.

Some states do not allow limitations on how long an implied warranty lasts or the exclusion or limitation of incidental or consequential damage, so the above limitations or exclusions may not apply to you.

This warranty gives you specific legal rights, and you may also have other rights, which vary from state-to-state.

Marlen Textiles

Softouch™ is a trademark of Marlen Textiles.

Stamoid® Marine Fabrics

5-Year

Five Year Limited Warranty

I. WARRANTY

STAMOID® MARINE FABRICS are warranted for a period of five (5) years from the date of purchase against extreme loss of color or strength from sunlight and other normal exposure conditions subsequent to normal use when properly maintained according to Stamoid recommendations.

- Breaking strength at least equal to 85% of its original value.
- Tear strength at least equal to 85% of its original value
- Uniform color degradation with the same exposure conditions
- Water-proofness

II. EXCLUSIONS

This warranty does not cover labor installation and fabrication work by the fabricator/dealer or damage caused by use or care of the product contrary to the use and care instructions listed below. The warranty is void if the nature of the complaint(s) come(s) from:

- Degradation due to inadequate transportation, storage, handling or malevolent degradation.
- Misuse of STAMOID® MARINE FABRICS for applications not intended for each specific product as detailed in the Stamoid Marine Brochure.
- Inadequate usage.
- Consequence of chemical or abrasion action or harsh environmental conditions.
- Inadequate maintenance. See item IV. Care and maintenance below.

III. CONDITIONS OF WARRANTY APPLICATION

This warranty starts on the delivery date of the STAMOID® MARINE FABRIC to the customer. Warranty is applicable only if the nature of the complaint is communicated by registered courier with notification of reception by Serge Ferrari N.A., in a maximum lead time of 30 calendar days after its appearance. The invoice for the fabric must be fully paid before registration of any claim can be made.

If the material was not purchased directly from Serge Ferrari N.A., the claim will be registered with the wholesale distributor or converter that actually supplied the STAMOID® MARINE FABRICS.

If the fabric becomes unserviceable within the terms of this warranty, Serge Ferrari N.A. will supply replacement STAMOID® MARINE FABRIC free of charge. This warranty does not cover labor and installation supplied by the dealer.

IV. Care and Maintenance

Regular cleaning and topcoat protectant application is required to ensure long life of the product. Stamoid recommends the use of IMAR Brand 'Stamoid' Marine Fabric cleaning and protectants products. Normal schedule of care is quarterly, while harsh environmental locations (extreme UV or caustic airborne particulate) will require more frequent care. In no circumstances should non-neutral pH or abrasive products be applied to Stamoid.

The Serge Ferrari Group.

Stamoid® is a registered trademark of The Serge Ferrari Group.

Starfire®

5-Year Pro Rated

Limited Warranty

Starfire® fabric, when used for awning applications, is guaranteed for a period of five (5) years from date of installation against: excessive loss of color or strength from normal exposure conditions, including sunlight and normal atmospheric chemicals, which may render it unserviceable. In the unlikely event of fabric failure, this warranty provides replacement yardage to you, the original owner of the awning, as follows.

One (1) year from date of installation, new fabric equal to twice the amount used on the job; After 1 year, an allowance equal to 1/60 of the purchase price of the original material for each month remaining in the initial five (5) year period of use.

This warranty protects you against damage to awnings used under normal conditions. It does not cover damage from acts of God, vandalism, neglect or improper use. This warranty is in lieu of all warranties expressed or implied, and, Trivantage will not be liable for any consequential or incidental damage. Any implied warranties imposed by law are limited in time to the duration

of the expressed warranty. Some states do not allow limitations on how long an implied warranty lasts or the exclusion or limitation of incidental or consequential damage, so, the above limitation or exclusion may not apply to you. This warranty gives you specific legal rights and you may also have other rights, which may vary from state to state.

* Minimal color loss can be anticipated on most light shades after constant exposure to sunlight. Darker shades have longer color retention.

Trivantage, LLC

Starfire® is a registered trademark of Glen Raven, Inc.

Sunbrella®

Coverage Varies By Product Line

Sunbrella® limited warranty. We stand behind our fabrics with a guarantee that's the best in the industry: a 5-year limited warranty for upholstery, specialty fabrics and decorative shade fabrics and a 10-year limited warranty for shade and marine fabrics.

5 YEAR LIMITED WARRANTY

Covers Sunbrella Upholstery Fabrics, Sunbrella Alloy, Sunbrella Clarity, Sunbrella Contour, Sunbrella Fundamental, Sunbrella Plus, Sunbrella Supreme and Sunbrella Unity.

10 YEAR LIMITED WARRANTY

Covers Sunbrella Shade and Marine Fabrics

Performance improvements introduced on November 1, 2008 allowed Glen Raven to increase the warranty period for Sunbrella fabrics. For installations on or after November 1, 2008, the warranty coverage period is 10 years from the original purchase date. Glen Raven will provide replacement fabric at no cost during years one through eight. In the ninth year, Glen Raven will refund 85% of the original cost of the fabric, and in the tenth year, refund 70% of the original cost of the fabric.

This warranty applies to the original purchaser of Sunbrella fabric and protects against Sunbrella fabric becoming unserviceable due to color or strength loss from normal usage and exposure conditions, including sunlight, mildew and atmospheric chemicals.

This warranty covers Sunbrella fabric only. This warranty does not cover normal care and cleaning; damage from misuse or abuse; improper installation; or costs associated with replacement of the fabric, including labor and installation. Glen Raven's liability is expressly limited to this warranty. Glen Raven reserves the right to inspect the fabric submitted for claim. Glen Raven will supply new equivalent fabric to replace the fabric that becomes unserviceable.

Glen Raven Custom Fabrics, LLC

Sunbrella® is a registered trademark of Glen Raven, Inc.

Sunbrella® Graphics System

Limited Warranty

What is covered?

The SGS Thermal Film warranty covers Trivantage® SGS Thermal films (SGS Thermal Digital Print film and SGS Black Lettering film) applied to Glen Raven acrylic fabrics*, from loss of color, strength or adhesion of film to fabric from normal exposure conditions, including sunlight, mildew, rot and atmospheric chemicals. The warranty does not apply to printed images on the film. Graphics must be installed on a static fabric surface in order for the graphics adhesion warranty to apply. SGS Thermal films are covered up to 5 years on vertical and 3 years on for a non-vertical exposure. (See diagrams below).

Graphic Exposure Definitions



Vertical Exposure
The face of the graphic ± 10° from vertical.



Non-Vertical Exposure
The face of the graphic ± 45° from vertical.

The SGS Warranty is exclusively available from Trivantage to Certified SGS Manufacturers who have purchased the film and the fabric through Trivantage. The manufacturer agrees to keep detailed records of each project for the duration of the warranty period. The SGS warranty runs from the date of original installation. Warranty claims can be initiated by calling Trivantage customer service at 800-786-7608. Trivantage will supply you with replacement fabric and film after verification that the claim is justified.

What is not covered?

The warranty does not cover frames, labor or installation provided by the manufacturer. The warranty does not cover the performance of ink which has been printed or screened onto the film. This warranty does not cover damage caused by vandalism, cleaning solutions, paints, solvents, eradicable or other strong chemicals, pressure washing equipment, mechanical washing equipment that subjects the graphic to frequent abrasive scouring action, engine fuels, engine exhaust, steam, oil, grease, tree sap, fire, structural failure, lightning or other natural forces or acts of God.

*(Sunbrella, Sunbrella Clarity, Sunbrella Plus, Sunbrella Unity, Firesist, Dickson Orchestra)

This warranty gives you specific legal rights and you may also have other rights that vary state to state. Glen Raven makes no warranty of fitness for any particular purpose whatsoever with respect to the goods being sold. There are no warranties, express or implied, which extend beyond the description on the face of this agreement.

Trivantage

Sunbrella® and Trivantage® are registered trademarks of Glen Raven, Inc.

Sunbrella® Inkjet White

3-Year

What is covered?

This warranty covers Sunbrella® Inkjet White from becoming unserviceable because of loss of color or strength from normal exposure conditions, including sunlight, mildew, rot, and atmospheric chemicals. It does not cover graphics printed on the fabric or labor and installation provided by the dealer.

How long is the coverage period?

The warranty runs for three years from the date of original installation. What will Glen Raven do? Glen Raven will supply new fabric free of charge to replace the fabric, which becomes unserviceable.

How can you get service?

Call the dealer from whom you purchased the product to inspect the installation. The dealer will call Glen Raven and secure replacement fabric for you.

How does state law apply?

This warranty gives you specific legal rights and you may have other rights, which vary from state to state.

Glen Raven Custom Fabrics, LLC

Sunbrella® is a registered trademark of Glen Raven, Inc.

SunTex® 80 and 90

10-Year Exterior

Extended Limited Warranty

What is Covered?

This warranty covers SunTex® when properly handled and installed for normal use as exterior fixed screening. SunTex is also covered by this warranty for use in retractable roller systems. Phifer guarantees that, when delivered to our customer, Phifer Sun Control Products will meet or exceed all of our specifications with regard to mesh configuration, dimension, strength and color. Phifer further guarantees that Phifer Sun Control Products will not become nonfunctional because of changes in physical properties due to exposure to normal atmospheric conditions. This warranty does not cover damage to screen from any source nor does it cover gradual fading.

Any defects found with regard to mesh configuration, dimension, strength or color, that exist at the time of initial delivery, must be reported to Phifer within a reasonable period of time and before fabrication or installation of the material. Only full or partial rolls of Phifer Sun Control Products may be returned to Phifer for replacement under this warranty except as provided in the following paragraph.

The Phifer Sun Control Products mentioned above are covered by this warranty if the fabric becomes nonfunctional due to changes in physical properties. If the fabricated screen appears to be defective, it must be returned to Phifer without hardware or attachments to be inspected.

How Long Is The Coverage Period?

The warranty against changes in physical properties is valid for a period of ten (10) years.

What Will Phifer Do?

Any Phifer Sun Control Product found to be defective will be replaced, free of charge, with an equal quantity of Phifer Sun Control fabric.

THIS WARRANTY DOES NOT COVER THE COST OF LABOR OR OTHER CONSEQUENTIAL EXPENSES RELATED TO REMOVAL, RETURN OR RE-INSTALLATION OF PHIFER SUN CONTROL PRODUCTS.

THIS IS THE COMPLETE AND ONLY WARRANTY PROVIDED FOR PHIFER SUN CONTROL PRODUCTS. THERE ARE NO OTHER WARRANTIES, EXPRESS OR IMPLIED, FOR THIS PRODUCT.

Phifer Inc.

SunTex® is a registered trademark of Phifer Inc.

Sur Last®

3-Year

This limited warranty is valid only if a copy of the invoice for the item purchased is submitted showing date of original purchase.

What is covered?

This limited warranty covers the fabric becoming unserviceable because of loss of color or strength from normal usage and exposure conditions, including sunlight, mildew and atmospheric chemicals. Consumer is responsible for normal care and cleaning of the fabric. The warranty covers fabric only. Glen Raven's liability is expressly limited to this warranty.

How long is the coverage period?

This limited warranty coverage runs for three years from the date of original installation.

What will Glen Raven do?

Glen Raven will supply new fabric free to replace the fabric that becomes unserviceable.

How can you get service?

Call the dealer or retailer from whom you purchased the product to inspect the claim. They, in turn, will contact the manufacturer of the item purchased. The manufacturer will then contact Glen Raven and secure replacement fabric for you.

Glen Raven Custom Fabrics, LLC

Sur Last® is a registered trademark of Glen Raven, Inc.

Textilene® 90 and 95

10-Year

Twitchell Corporation produces durable, all weather fabrics that are unmatched for quality and durability. Textilene® 80, Textilene® 90 & Textilene® 95 brand fabrics are covered by a 10 year limited warranty on commercial applications from the original date of purchase against defects of workmanship and materials, and/or excessive loss strength from normal exposure conditions, including sunlight, rot, mildew, or atmospheric chemicals that might render it unserviceable. This warranty is extended only to the original purchaser of the material.

If the product has been subject to damage, neglect, unreasonable or improper use or care, exposure to corrosive chemicals, accidents, vandalism, acts of God, or other causes not arising from defects in original material or workmanship, this warranty is void. Twitchell does not endorse or certify end uses and customers must test the fabrics for their specific applications.

In the unlikely event that the fabric should fail during the warranty period, Twitchell will issue a credit or replace the fabric at Twitchell's discretion. A copy of the original purchase order must accompany all warranty claims. Twitchell Corporation is liable for the cost of the fabric only and does not accept responsibility for any other costs associated with a company's specific application.

Any defects found in regard to fabric construction, color, strength, or dimension that exist at the time of delivery must be reported to Twitchell Corporation in a reasonable period of time and before any fabrication or alteration of the fabric.

Proper care includes regular cleaning. We recommend cleaning your fabric at least twice annually for residential applications and more often for high traffic areas or contract applications.

Twitchell Corporation

Textilene® is a registered trademark of Twitchell Corporation

Triton®

3-Year

Limited Warranty

Triton®, a registered trademark of Glen Raven, Inc, is warranted for a period of three years from the date of the original installation against excessive loss of color or strength from normal exposure conditions including sunlight, mildew, rot and normal atmospheric chemicals which may render the fabric unserviceable. This warranty does not cover damage from Acts of God, vandalism, neglect or improper use.

In the unlikely event of fabric failure during the warranty period, Graniteville Specialty Fabrics will supply you, the end consumer, new fabric free of charge working through Trivantage and your dealer. Labor and installation are not covered by this warranty. Graniteville Specialty Fabrics reserves the right to inspect the fabric or made up item of any warranty claim.

Except for the explicit warranties, herein, no other warranty, expressed or implied, including any implied warranty of merchantability of fitness for a particular use is made by Graniteville Specialty Fabrics. In no event shall Graniteville Specialty Fabrics be liable for damages to any person or property, or any consequential or incidental damages.

Some states do not allow limitations on how long an implied warranty lasts or the exclusion or limitation of consequential or incidental damage, so, the above limitation or exclusion may not apply to you. This warranty gives you specific legal rights and you may have other rights which vary from state to state.

To get service, call the dealer from whom you purchased the product. The dealer will inspect the installation and process the claim through Trivantage, LLC and Graniteville Specialty Fabrics.

Graniteville Specialty Fabrics

Triton® is a registered trademark of Glen Raven, Inc.

Weathertyte®

8-Year

8 Year Limited Warranty

Terms:

Cooley Sign & Awning Products (CSP) warrants that Weathertyte standard colors, when used in a front-lit awning application, and when fabricated, installed and maintained according to instructions, will perform and provide outdoor weatherability (1) from the date of sign or awning fabrication and (2) under normal exposure conditions provided that the Cooley and other materials³ are properly stored and are applied within two years² of the original shipment date from Cooley. This warranty is contingent on the Cooley material being processed in accordance with Cooley Group's recommended written processing instructions, and being applied to properly prepared surfaces and cleaned and maintained in accordance with recommended Cooley's application procedures. Projects of 10 or more awnings require registration. Certification of fabrication techniques may be required by a Cooley Group representative. To register, call the Cooley Sign & Awning Customer Service at 1-800-992-0072.

"Outdoor Weatherability" for the purpose of this warranty is defined as no appreciable deterioration in the product when viewed from its intended viewing distance. Premature failure due to cracking, crazing, blistering, blowout⁶ or loss of adhesion shall constitute a breach of warranty if it occurs during the warranty period. Replacement substrate and graphics will be warranted for the period corresponding to the remaining warranty period of the original failed material. Slight color change, fading, chalking, edge lifting, or slight reduction in gloss will not materially detract from appearance and does not constitute a breach of warranty. In the event a breach of warranty occurs as defined above, Cooley Group's sole liability is outlined below.

A. Warranty Against Fabrication Failure

Replacement of Cooley material and decoration film in an amount equal to the value of the materials that failed during fabrication. It is the sign or awning manufacturers responsibility to perform incoming raw material quality inspections, to implement appropriate manufacturing process controls including in-process testing, retain converted samples, and to immediately cease using and notify Cooley of any materials deemed defective.

B. Warranty Against Field Performance Failure

Years 1-5 (full material replacement):

For a period of five (5) years from the date of original installation. If the material does not perform under the above conditions, Cooley will supply to the awning company sufficient Weathertyte material to produce a new duplicate awning. This warranty is for fabric only and does not cover frames, labor, or installation provided by the manufacturer. This limited warranty is valid only if a copy of the invoice for the item purchased is submitted showing date of original purchase.

Years 6-8 (prorated material allowance):

If a material fails to perform in years 6-8, Cooley Sign & Awning will provide an allowance for the defective Cooley and associated decoration material used in remanufacture of the defective sign or awning calculated using the following formula:

$$\text{Allowance} = A \times \frac{96 - B}{96}$$

Where A = Value of replacement materials⁴
 B = Number of months since manufacture or shelf-life expiration date.

where A= Value of replacement materials⁴, B= Number of months since manufacture or shelf-life expiration date.

C. Decoration

Cooley Sign & Awning Products further warrants that approved pressure sensitive vinyl, when applied to Weathertyte by the approved application methods, will not peel off under normal weathering conditions for a period of for 5 years for vertical exposure, and 3 years for non-vertical exposure in most of the United States and Canada, and three years for vertical and two years for non-vertical exposure in the Desert Southwest (Arizona, New Mexico, and desert areas of California, Nevada, Utah, and Texas.). If the pressure sensitive vinyl should peel off under the above conditions, Cooley Sign & Awning Products will supply new material to restore the awning at the then current price prorated (1/60) for each month remaining in the original warranty period.

The foregoing is not applicable to awnings which have been damaged by chemicals, airborne particles or dirt, bird droppings, or water run-off, nor to awnings damaged by willful neglect or negligent mishandling, nor to awnings which excessively fade or discolor due to use of non-recommended decorating techniques. Cooley's liability under the warranty is limited to replacement as stated herein and Cooley will have no liability for any indirect or consequential expenses or losses.

This warranty is given in lieu of all other warranties expressed or implied and constitutes Cooley's sole eight (8)-year warranty for Weathertyte when used for front-lit awnings.

Notification of Claim

This Cooley Warranty requires that Cooley Sign & Awning be notified in writing of any claims within twenty one (21) days of material failure. Claim notifications must include name and lot numbers for Cooley material and films, report of fabrication procedures, in-process test results, finished retain samples, installation date and location, name of sign or awning manufacturer, and any other pertinent information requested by Cooley. The Cooley Group reserves the right to inspect all reported claims. Failure to comply constitutes a waiver of all rights under this Cooley Warranty.

The Cooley Group has no obligations under this warranty with respect to products that have been modified or damaged through misuse, abuse, accident, neglect or mishandling by Purchaser or Purchaser's customer. For example, unless specifically claimed in an Cooley Product or Bulletin, materials are not warranted against premature failure caused by chemical or mechanical means such as, but not limited to, vandalism, cleaning solutions, paints, solvents, mechanical washing equipment, engine fuel spills, engine exhaust, steam, organic solvents or other spilled chemicals. Substrates and films applied to unsound sign or awning boxes for frames or surfaces that subsequently rust, crack, peel, outgas, or become damaged beneath the flexible material are not warranted for performance. Damage from fire, structural failure, lightning, and other force majeure events are not covered.

Unintended Use of Products

Cooley products covered by this warranty are intended only for use by professional users and only for the intended uses as described in the corresponding Cooley Product Brochures. Before using for any other application, user shall determine the suitability of the product for its intended use and user assumes all risk and liability in connection therewith.

NO EXPRESS WARRANTIES AND NO IMPLIED WARRANTIES, WHETHER OF MERCHANTABILITY OR FITNESS FOR ANY PARTICULAR USE, OR OTHERWISE, EXCEPT AS SET FORTH ABOVE (WHICH IS MADE EXPRESSLY IN LIEU OF ALL OTHER WARRANTIES) SHALL APPLY TO THE PRODUCTS DESCRIBED HEREIN. THE COOLEY GROUP SPECIFICALLY DISCLAIMS AND EXCLUDES ALL OTHER SUCH WARRANTIES. NO WAIVER, ALTERATION, ADDITION OR MODIFICATION OF THE FOREGOING

SHALL BE VALID UNLESS MADE IN WRITING AND SIGNED BY AN AUTHORIZED REPRESENTATIVE OF THE COOLEY GROUP.

IN NO EVENT SHALL THE COOLEY GROUP BE LIABLE FOR ANY INCIDENTAL OR CONSEQUENTIAL DAMAGES INCLUDING, BUT NOT LIMITED TO, LOSS OF PROFIT, LOSS OF USE OR PRODUCTION OR LOSS OF CAPITAL. THE COOLEY GROUP'S LIABILITY ON ANY CLAIM OF ANY KIND SHALL IN NO CASE EXCEED THE AMOUNT EXPRESSLY PROVIDED FOR IN THIS WARRANTY. THIS LIMITATION APPLIES REGARDLESS OF WHETHER THE DAMAGES ARE SOUGHT BASED ON BREACH OF WARRANTY, BREACH OF CONTRACT, NEGLIGENCE, STRICT LIABILITY IN TORT, OR ANY OTHER LEGAL THEORY.

- (1) Some products are warranted for less years depending on the color and the location of the final sign or awning installation. Refer to the Cooley Zone Warranty for details.
- (2) Cooley Sign & Awning products have a 2 year shelf life from date of sale from Cooley to the customer. In the event that a material exceeds its shelf life, Cooley's warranty period will be calculated from the shelf line expiration date or the date of installation, which ever is less.
- (3) Refer to the Cooley Group website for approve pressure sensitive films, paints, etc.
- (4) Current exchange rates will be used to settle all international claims.
- (5) If the stated durability of the decoration materials differs from that of the Cooley material the finished sign or awning will be warranted for a period equal to the stated durability of the least durable component.
- (6) If the sign face is properly installed and maintained and within the warranty period the sign face should be destroyed or severely damaged by a "blowout" (defined as a separation of a sign face from its cabinet due to wind pressure which does not affect the display cabinet or structure), and when such "blowout" is caused solely and completely by failure of CSP sign face materials, and not in whole or part by improper workmanship, installation, materials, nor bending or twisting of the display cabinet, attachment devices, or structure, nor to the vandalism or malicious mischief, hurricanes, tornadoes, gales or other acts of God, Cooley will provide an allowance in accordance with this warranty.
- (7) Cooley Sign & Awning Products approved cleaning products and procedures are printed in Technical Bulletin #105.
- (8) Cooley Sign & Awning Products will have no obligation under this warranty until all bills have been paid in full.

Cooley Sign & Awning Products
 Weathertyte® is a registered trademark of Cooley, Inc.

Weathertyte® Lite

5-Year

5 Year Limited Warranty

Terms:

Cooley Sign & Awning Products (CSP) warrants that Weathertyte Lite standard colors, when used in a front-lit awning application, and when fabricated, installed and maintained according to instructions, will perform and provide outdoor weatherability¹ from the date of sign or awning fabrication and² under normal exposure conditions provided that the Cooley and other materials³ are properly stored and are applied within two years² of the original shipment date from Cooley. This warranty is contingent on the Cooley material being processed in accordance with Cooley Group's recommended written processing instructions and being applied to properly prepared surfaces and cleaned and maintained in accordance with recommended Cooley's application procedures. Projects of ten (10) or more awnings require registration. Certification of fabrication techniques may be required by a Cooley Group representative. To register, call Cooley Sign & Awning Customer Service at 1-800-992-0072.

“Outdoor Weatherability” for the purpose of this warranty is defined as no appreciable deterioration in the product when viewed from its intended viewing distance. Premature failure due to cracking, crazing, blistering, blowout⁵ or loss of adhesion shall constitute a breach of warranty if it occurs during the warranty period. Replacement substrate and graphics will be warranted for the period corresponding to the remaining warranty period of the original failed material. Slight color change, fading, chalking, edge lifting, or slight reduction in gloss will not materially detract from appearance and does not constitute a breach of warranty. In the event a breach of warranty occurs as defined above, Cooley Group’s sole liability is outlined below.

A. Warranty Against Fabrication Failure

Replacement of Cooley material is an amount equal to the value of the materials that failed during fabrication. It is the responsibility of the sign or awning manufacturer to perform incoming raw material quality inspections, to implement appropriate manufacturing process controls including in-process testing, retain converted samples, and to immediately cease using and notify Cooley of any materials deemed defective.

B. Warranty Against Field Performance Failure - Years 1-5

Cooley will provide an allowance for the defective Cooley material used in remanufacture of the defective sign or awning, calculated using the following formula:

$$\text{Allowance} = A \times \frac{(60 - B)}{60} \quad \text{Where } \begin{matrix} A = \text{Value of replacement materials}^4 \\ B = \text{Number of months since manufacture} \\ \text{or shelf-life expiration date.} \end{matrix}$$

where A= Value of replacement materials⁴, B= Number of months since manufacture or shelf-life expiration date.

C. Decoration

Cooley Sign & Awning Products further warrants that approved pressure sensitive vinyl, when applied to Weathertyte Lite by the approved application methods, will not peel off under normal weathering conditions for a period for five (5) years for vertical exposure in most of the United States and Canada, and three years for vertical exposure in the Desert Southwest (Arizona, New Mexico, and desert areas of California, Nevada, Utah, and Texas.). If the pressure sensitive vinyl should peel off under the above conditions, Cooley Sign & Awning Products will supply new material to restore the awning at the then current price prorated (1/60) for each month remaining in the original warranty period.

The foregoing is not applicable to awnings which have been damaged by chemicals, airborne particles or dirt, bird droppings, or water run-off, nor to awnings damaged by willful neglect or negligent mishandling, nor to awnings which excessively fade or discolor due to use of non-recommended decorating techniques. Cooley’s liability under the warranty is limited to replacement as stated herein and Cooley will have no liability for any indirect or consequential expenses or losses.

This warranty is given in lieu of all other warranties expressed or implied and constitutes Cooley’s sole five (5)-year warranty for Weathertyte Lite when used for front-lit awnings.

D. Notification of Claim

This Cooley warranty requires that Cooley Sign & Awning Products be notified in writing of any claims within twenty- one (21) days of material failure. Claim notifications must include name and lot numbers for Cooley material and films, report of fabrication procedures, in-process test results, finished retain samples, installation date and location, name of sign or awning manufacturer, and any other pertinent information requested by Cooley. The Cooley Group reserves the right to inspect all reported claims. Failure to comply constitutes a waiver of all rights under this Cooley warranty.

The Cooley Group has no obligations under this warranty with respect to products that have been modified or damaged through misuse, abuse, accident, neglect or mishandling by Purchaser or Purchaser’s customer. For example, unless specifically claimed in a Cooley product or bulletin, materials

are not warranted against premature failure caused by chemical or mechanical means such as, but not limited to, vandalism, cleaning solutions, paints, solvents, mechanical washing equipment, engine fuel spills, engine exhaust, steam, organic solvents or other spilled chemicals. Substrates and films applied to unsound sign or awning boxes for frames or surfaces that subsequently rust, crack, peel, outgas, or become damaged beneath the flexible material are not warranted for performance. Damage from fire, structural failure, lightning, and other force majeure events are not covered.

E. Unintended Use of Products

Cooley products covered by this warranty are intended only for use by professional users and only for the intended uses as described in the corresponding Cooley product brochures. Before using for any other application, user shall determine the suitability of the product for its intended use and user assumes all risk and liability in connection therewith.

NO EXPRESS WARRANTIES AND NO IMPLIED WARRANTIES, WHETHER OF MERCHANTABILITY OR FITNESS FOR ANY PARTICULAR USE, OR OTHERWISE, EXCEPT AS SET FORTH ABOVE (WHICH IS MADE EXPRESSLY IN LIEU OF ALL OTHER WARRANTIES) SHALL APPLY TO THE PRODUCTS DESCRIBED HEREIN. THE COOLEY GROUP SPECIFICALLY DISCLAIMS AND EXCLUDES ALL OTHER SUCH WARRANTIES. NO WAIVER, ALTERATION, ADDITION OR MODIFICATION OF THE FOREGOING SHALL BE VALID UNLESS MADE IN WRITING AND SIGNED BY AN AUTHORIZED REPRESENTATIVE OF THE COOLEY GROUP.

IN NO EVENT SHALL THE COOLEY GROUP BE LIABLE FOR ANY INCIDENTAL OR CONSEQUENTIAL DAMAGES INCLUDING, BUT NOT LIMITED TO, LOSS OF PROFIT, LOSS OF USE OR PRODUCTION OR LOSS OF CAPITAL. THE COOLEY GROUP’S LIABILITY ON ANY CLAIM OF ANY KIND SHALL IN NO CASE EXCEED THE AMOUNT EXPRESSLY PROVIDED FOR IN THIS WARRANTY. THIS LIMITATION APPLIES REGARDLESS OF WHETHER THE DAMAGES ARE SOUGHT BASED ON BREACH OF WARRANTY, BREACH OF CONTRACT, NEGLIGENCE, STRICT LIABILITY IN TORT, OR ANY OTHER LEGAL THEORY.

- (1) Some products are warranted for less years depending on the color and the location of the final sign or awning installation. Refer to the Cooley Zone Warranty for details.
- (2) Cooley Sign & Awning products have a 2 year shelf life from date of sale from Cooley to the customer. In the event that a material exceeds its shelf life, Cooley’s warranty period will be calculated from the shelf life expiration date or the date of installation, whichever is less.
- (3) Refer to the Cooley Group website for approved pressure sensitive films, paints, etc.
- (4) Current exchange rates will be used to settle all international claims.
- (5) If the sign face is properly installed and maintained and within the warranty period and the sign face should be destroyed or severely damaged by a “blowout” (defined as a separation of a sign face from its cabinet due to wind pressure which does not affect the display cabinet or structure), and when such “blowout” is caused solely and completely by failure of CSP sign face materials, and not in whole or part by improper workmanship, installation, materials, nor bending or twisting of the display cabinet, attachment devices, or structure, nor to the vandalism or malicious mischief, hurricanes, tornadoes, gales or other acts of God, Cooley will provide an allowance in accordance with this warranty.
- (6) Cooley Sign & Awning Products approved cleaning products and procedures are printed in Technical Bulletin #105.
- (7) Cooley Sign & Awning Products will have no obligation under this warranty until all bills have been paid in full.

Cooley Sign & Awning Products
Weathertyte® is a registered trademark of Cooley, Inc.

Weblon® Coastline Plus®

5-Year

Limited Warranty

Coastline Plus® Awning Fabrics are guaranteed for a period of five (5) years from date of original installation against rot or excessive deterioration, mildew stains, excessive loss of strength or color change if they occur in normal use and exposure, including sunlight and normal atmospheric chemicals. (Some color change is unavoidable due to ultraviolet rays and chemicals in the atmosphere.)

In the unlikely event of failure of fabric during the five (5) year period from date of original installation, we will supply you, the original owner or the provider of your protective fabric accessories with replacement fabric at no charge.

This warranty protects you against damage to the fabric accessories used under normal conditions. It does not cover damage to the fabric from acts of God, vandalism, neglect or improper use.

This warranty is in lieu of all warranties expressed or implied, and, Herculite Products Inc. will not be liable for any consequential or incidental damage. Any implied warranties imposed by law are limited in time to the duration of the expressed warranty.

Some states do not allow limitations on how long an implied warranty lasts or the exclusion or limitation of incidental or consequential damage, so, the above limitation or exclusion may not apply to you. This warranty gives you specific legal rights and you may also have other rights, which vary from state to state

Herculite Products Inc.

Weblon® and Coastline Plus® are trademarks of Herculite Products Inc.

Weblon® Regatta® Yacht Fabric

5-Year

Limited Warranty

Regatta® Yacht Fabrics are guaranteed for a period of five (5) years from date of original installation against rot or excessive deterioration, mildew stains, excessive loss of strength or color change if they occur in normal use and exposure, including sunlight and normal atmospheric chemicals. (Some color change is unavoidable due to ultraviolet rays and chemicals in the atmosphere.)

In the unlikely event of failure of fabric during the five (5) year period from date of original installation, we will supply you, the original owner or the provider of your protective fabric accessories with replacement fabric at no charge.

This warranty protects you against damage to the fabric accessories used under normal conditions. It does not cover damage to the fabric from acts of God, vandalism, neglect or improper use.

This warranty is in lieu of all warranties expressed or implied, and, Herculite Products Inc. will not be liable for any consequential or incidental damage. Any implied warranties imposed by law are limited in time to the duration of the expressed warranty.

Some states do not allow limitations on how long an implied warranty lasts or the exclusion or limitation of incidental or consequential damage, so, the above limitation or exclusion may not apply to you. This warranty gives you specific legal rights and you may also have other rights, which vary from state to state.

Herculite Products Inc.

Weblon® and Regatta® are trademarks of Herculite Products Inc.

Weblon® Vanguard®

8-Year

Limited Warranty

Vanguard® Awning Fabrics are guaranteed for a period of eight (8) years from date of original installation against rot or excessive deterioration, mildew stains, excessive loss of strength or color change if they occur in normal use and exposure, including sunlight and normal atmospheric chemicals. (Some color change is unavoidable due to ultraviolet rays and chemicals in the atmosphere.)

In the unlikely event of failure of fabric during the eight (8) year period from date of original installation, we will supply you, the original owner or the provider of your protective fabric accessories with replacement fabric at no charge.

This warranty protects you against damage to the fabric accessories used under normal conditions. It does not cover damage to the fabric from acts of God, vandalism, neglect or improper use.

This warranty is in lieu of all warranties expressed or implied, and, Herculite Products Inc. will not be liable for any consequential or incidental damage. Any implied warranties imposed by law are limited in time to the duration of the expressed warranty.

Some states do not allow limitations on how long an implied warranty lasts or the exclusion or limitation of incidental or consequential damage, so, the above limitation or exclusion may not apply to you. This warranty gives you specific legal rights and you may also have other rights, which vary from state to state.

Herculite Products Inc.

Vanguard® is a trademark of Herculite Products Inc.



Solair® Pro Retractable Awning

The Solair Pro is the ultimate solution for beautiful, stylish shade. Available in a wide range of fabrics, customizable sizes and modern frame color choices, the Pro will create a more finished, personalized look to your customers' outdoor oasis.

Standard Features

Frame: Corrosion-resistant, electrostatic powder-coated aluminum.

Arms: Sturdy construction with self-lubricating middle hinge and upper arm attachment sleeve bushings to provide smooth, quiet operation and wear reduction. An elliptical cable path in the hinge allows for cables to hold tension in the arm springs for consistent operation and a tight fabric appearance.

Hardware: The Pro is manufactured with durable stainless steel, corrosion-resistant fasteners. Finished look with protective caps and covers to hide most exposed hardware.

Pitch: Adjustable locking awning pitch from 5° to 60° for maximum shade control.

Performance: Earned TUV Certification for its quality, durability and workmanship.

Front Bar: Extruded aluminum front bar engineered for long-lasting strength and durability. Front bar features a rain channel to prevent water from gathering. Dual action front bar attachment increases flexibility and reduces strain on arms during wind gusts.

Roller Tube: Galvanized steel roller tube provides greater strength and less deflection. (Use of a center support may still be recommended.)

Styling

Frame Colors: White, Latte, Sand and Cocoa.

Fabric Options: Hundreds of fabric choices from Sunbrella® and Dickson® brands.

Available Sizes

Widths: Custom 8 feet to 30 feet. All units greater than 25 feet wide will be spliced and shipped in two pieces requiring some field assembly before installation.

Projections: 5 feet, 6 feet 11 inches, 8 feet 7 inches, 10 feet 2 inches, 11 feet 6 inches and 13 feet.

Motorized Operation

We recommend that the Solair Pro unit be motorized, for ease of use. We offer three standard RTS motor options based on the size of the unit (specifications listed on page #140). Hand held remote allows awning operation with the touch of a button from 65 feet away.

Some motors are available with a manual override option (CMO) for added safety in case of power loss.

Motorization also allows for additional electronic options such as wind and sun sensors (Somfy electronics covered on page #143).

Optional Features

Remote Control: Allows awning operation with the touch of a button from up to 65 feet away (standard on motorized awnings).

Protective Hood: Protects fabric and motor while providing a finished look.

Awning Assist Brace: Removable brace engineered to add support and stability to any Solair retractable awning.

Valance: Choose from several styles – from traditional scalloped edges to modern straight lines.

Valance Plus: Screen or solid fabric unwinds from front valance to provide additional shade and privacy.

Additional Information

Solair XP Units allow for greater projections in narrower spaces. Ask a sales representative for more details.

Solair awnings can be mounted to the structural part of most buildings. Different types of brackets are required in certain applications. Contact your Trivantage sales representative or a Solair Technical Specialist for help in determining the best bracket for your application by calling 877.899.1680 or e-mailing us at: help@solair.com.

The Installation Package Includes

- Installed Motor
- Motor Bracket or Installation Kit for CMO Motors
- Crown
- Drive Wheel
- Switch and Plate (if standard motor)
- Switch Box and Power Cord (if plug-in motor)
- **Standard motor options include: (Extra cost varies)**
 - 1) Somfy 550 RTS – for units up to 24 feet when CMO is not required
 - 2) Sunea 550 RTS CMO – for units up to 24 feet when CMO is required
 - 3) Simu 660 RTS CMO – for units wider than 24 feet; CMO is standard
- **Remote Control Options: (Extra cost varies)**
 - 1) 274552 Single Channel Pure
 - 2) 274550 Four Channel Pure
 - 3) 274553 Single Channel Patio (weather resistant)
 - 4) 274551 Four Channel Patio (weather resistant)

General Installation Requirements

Installation manuals come standard with every awning. Please contact the Solair technical support team at 877.889.1680 with all installation questions.

The motor cable should not act as a direct conduit for water to enter the head of the motor. Note: Somfy motors conform to IP44 requirements and as such must be protected against direct weather elements such as rain, sleet, etc. In order to avoid water penetration, form a "drip loop" with the power cable and use a hood when required.

RTS Motor Installation Requirements

If the installation consists of multiple RTS motors, only one motor can be programmed at a time. All other motors must be disconnected. This will avoid interferences during the initial programming of each motor. The mounting distance between any two RTS motor heads should be no less than 19 inches to avoid possible interference.

WARRANTY	10-year limited warranty on Solair Pro framework. 10-year limited warranty on Sunbrella shade fabrics. 5-year limited warranty for specialty and decorative shade fabrics. 5-year warranty on Somfy motors. All warranties are good from the day of purchase. Complete warranties can be found online at Solair Shade Solutions Extranet.
-----------------	---

Solair®, Sunbrella® and Dickson® are registered trademarks of Glen Raven, Inc.
Somfy® is a registered trademark of Somfy Systems, Inc.
WireFree™ is a trademark of Somfy Systems, Inc.



Solair® Pro Hood Kit

Kits include new Solair Pro Hood, End Covers, and Hood Brackets in quantity appropriate for specified width.

Available Sizes

Widths: Hood kits are made to order from 8ft to 30ft wide. Orders over 24ft require splicing in the field.

Available Colors

- Cocoa
- Latte
- Sand
- White

Solair® is a registered trademark of Glen Raven, Inc.

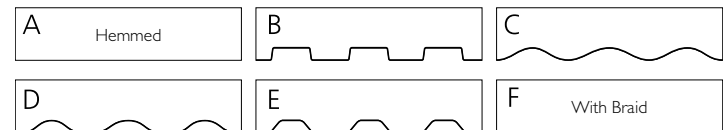

Standard Valance Styles

Solair® Pro Awning Covers

Save fabrication time! We offer quality covers for the Solair Pro. Covers are offered in any standard pattern of Sunbrella® and Dickson® awning fabric. (Other fabric styles upon request.) All Pro covers have welded seams unless otherwise noted.

Replacement covers and valances are available by special order. Please contact a Trivantage associate for details.

WARRANTY	10-year limited warranty on Solair Pro framework. 10-year limited warranty on Sunbrella shade fabrics. 5-year limited warranty for specialty and decorative shade fabrics. All warranties are good from the day of purchase. Complete warranties can be found online at Solair Shade Solutions Extranet.
-----------------	--

Solair®, Sunbrella® and Dickson® are registered trademarks of Glen Raven, Inc.



ITEM #	STYLE #	DESCRIPTION	COLOR
254136	RAL9010	0.6 oz. Brush Top Bottle	White
254137	RAL1019	0.6 oz. Brush Top Bottle	Latte
254138	RAL1013	0.6 oz. Brush Top Bottle	Sand
254139	RAL8017	0.6 oz. Brush Top Bottle	Cocoa

Solair® is a registered trademark of Glen Raven, Inc.

Solair® Pro Components

ITEM #	DESCRIPTION	COLOR	MATERIAL	STANDARD PACKAGE
231916	Arm 10 ft. 2 in.	Cocoa		2
231716	Arm 10 ft. 2 in.	Latte		2
231816	Arm 10 ft. 2 in.	Sand		2
231616	Arm 10 ft. 2 in.	White		2
231917	Arm 11 ft. 6 in.	Cocoa		2
231717	Arm 11 ft. 6 in.	Latte		2
231817	Arm 11 ft. 6 in.	Sand		2
231617	Arm 11 ft. 6 in.	White		2
231918	Arm 13 ft.	Cocoa		2
231718	Arm 13 ft.	Latte		2
231818	Arm 13 ft.	Sand		2
231618	Arm 13 ft.	White		2
231913	Arm 5 ft.	Cocoa		2
231713	Arm 5 ft.	Latte		2
231813	Arm 5 ft.	Sand		2
231613	Arm 5 ft.	White		2
231914	Arm 6 ft. 11 in.	Cocoa		2
231714	Arm 6 ft. 11 in.	Latte		2
231814	Arm 6 ft. 11 in.	Sand		2
231614	Arm 6 ft. 11 in.	White		2
231915	Arm 8 ft. 7 in.	Cocoa		2
231715	Arm 8 ft. 7 in.	Latte		2
231815	Arm 8 ft. 7 in.	Sand		2
231615	Arm 8 ft. 7 in.	White		2
231697	Beam Bracket	White	Powder Coated Steel	1
231902	Center Support	Cocoa		1
231702	Center Support	Latte		1
231802	Center Support	Sand		1
231602	Center Support	White		1
231904	Conical Gear 4.4:1	Cocoa		1
231704	Conical Gear 4.4:1	Latte		1
231804	Conical Gear 4.4:1	Sand		1
231604	Conical Gear 4.4:1	White		1
231986	Front Bar 16 ft.	Cocoa	Extruded Aluminum	1
231786	Front Bar 16 ft.	Latte	Extruded Aluminum	1
231886	Front Bar 16 ft.	Sand	Extruded Aluminum	1
231686	Front Bar 16 ft.	White	Extruded Aluminum	1
231987	Front Bar 20 ft.	Cocoa	Extruded Aluminum	1
231787	Front Bar 20 ft.	Latte	Extruded Aluminum	1
231887	Front Bar 20 ft.	Sand	Extruded Aluminum	1
231687	Front Bar 20 ft.	White	Extruded Aluminum	1

Solair® Pro Valance Plus System

The Solair Pro Valance Plus System is a vertical roll-down drop valance option that provides protection from the setting sun. A standard 4-foot vertical fabric drop from the front bar is optimal for western exposures.

The Valance Plus System consists of a cassette and a drop valance fabric (valance fabric sold separately). The design of the cassette also accommodates a standard fixed valance. The Valance Plus cassette is available in white, latte, sand and cocoa frame colors. The system is only available for the Pro unit with projections up to 10ft 2in and widths up to 20ft. Allow for additional delivery time.

WARRANTY	
	10-year limited warranty on Solair Pro Valance Plus framework. Fabric warranties will vary but most have 5 or 10 year limited warranties.

Solair® is a registered trademark of Glen Raven, Inc.

Solair® Pro Valance Plus Fabric

Solair Pro Valance Plus Fabric is supplied for use in the Solair Pro Valance Plus System. The fabric is available in widths from 10 feet to 20 feet, with a standard drop of four feet. Choose from a selection of 60 inch Sunbrella® solids, or select a Sunbrella pattern that coordinates with your awning cover fabric. Also available in 90% Textilene® in five stock colors (Black, Brown, Beige, Grey and Desert Sand).

Solair® and Sunbrella® are registered trademarks of Glen Raven, Inc. Textilene® is a registered trademark of Twitchell Corporation.

Solair® Touch-Up Paint

A lacquer base, touch-up paint for Solair. Ideal for touching up small areas.

ITEM #	STYLE #	DESCRIPTION	COLOR
254130	RAL9010	12 oz. Aerosol Can	White
254131	RAL9019	12 oz. Aerosol Can	Latte
254132	RAL1013	12 oz. Aerosol Can	Sand
254133	RAL8017	12 oz. Aerosol Can	Cocoa

ITEM #	DESCRIPTION	COLOR	MATERIAL	STANDARD PACKAGE
231988	Front Bar 24 ft.	Cocoa	Extruded Aluminum	1
231788	Front Bar 24 ft.	Latte	Extruded Aluminum	1
231888	Front Bar 24 ft.	Sand	Extruded Aluminum	1
231688	Front Bar 24 ft.	White	Extruded Aluminum	1
231908	Front Bar Attachment	Cocoa		2
231708	Front Bar Attachment	Latte		2
231808	Front Bar Attachment	Sand		2
231608	Front Bar Attachment	White		2
231909	Front Bar End Cap	Cocoa	Plastic	2
231709	Front Bar End Cap	Latte	Plastic	2
231809	Front Bar End Cap	Sand	Plastic	2
231609	Front Bar End Cap	White	Plastic	2
231990	Hood 16 ft.	Cocoa	Aluminum	1
231790	Hood 16 ft.	Latte	Aluminum	1
231890	Hood 16 ft.	Sand	Aluminum	1
231690	Hood 16 ft.	White	Aluminum	1
231991	Hood 20 ft.	Cocoa	Aluminum	1
231791	Hood 20 ft.	Latte	Aluminum	1
231891	Hood 20 ft.	Sand	Aluminum	1
231691	Hood 20 ft.	White	Aluminum	1
231992	Hood 24 ft.	Cocoa	Aluminum	1
231792	Hood 24 ft.	Latte	Aluminum	1
231892	Hood 24 ft.	Sand	Aluminum	1
231692	Hood 24 ft.	White	Aluminum	1
231657	Hood Bracket	Cocoa	Extruded Aluminum	2
231655	Hood Bracket	Latte	Extruded Aluminum	2
231656	Hood Bracket	Sand	Extruded Aluminum	2
231654	Hood Bracket	White	Extruded Aluminum	2
231920	Hood End Cap	Cocoa	Aluminum	2
231720	Hood End Cap	Latte	Aluminum	2
231820	Hood End Cap	Sand	Aluminum	2
231620	Hood End Cap	White	Aluminum	2
231905	Retention Pin	Cocoa	Nylon	2
231705	Retention Pin	Latte	Nylon	2
231805	Retention Pin	Sand	Nylon	2
231605	Retention Pin	White	Nylon	2
231500	Roller Tube 16 ft x 78 mm		Galvanized Steel	1
270255	Roller Tube 16 ft. x 80 mm		Aluminum	1
231501	Roller Tube 20 ft. x 78 mm		Galvanized Steel	1
270256	Roller Tube 20 ft. x 80 mm		Aluminum	1
231502	Roller Tube 24 ft. x 78 mm		Galvanized Steel	1
270257	Roller Tube 24 ft. x 80 mm		Aluminum	1

ITEM #	DESCRIPTION	COLOR	MATERIAL	STANDARD PACKAGE
231503	Roller Tube 30 ft. x 78 mm		Galvanized Steel	1
231901	Roller Tube Support Bracket Set with Covers	Cocoa	Extruded Aluminum, Plastic	2
231701	Roller Tube Support Bracket Set with Covers	Latte	Extruded Aluminum, Plastic	2
231801	Roller Tube Support Bracket Set with Covers	Sand	Extruded Aluminum, Plastic	2
231601	Roller Tube Support Bracket Set with Covers	White	Extruded Aluminum, Plastic	2
231508	Round Gudgeon 80 mm		Plastic	1
231907	Shoulder for 13 ft. Arms	Cocoa		2
231707	Shoulder for 13 ft. Arms	Latte		2
231807	Shoulder for 13 ft. Arms	Sand		2
231607	Shoulder for 13 ft. Arms	White		2
231906	Shoulder for up to 11 ft. 6 in. Arms	Cocoa		2
231706	Shoulder for up to 11 ft. 6 in. Arms	Latte		2
231806	Shoulder for up to 11 ft. 6 in. Arms	Sand		2
231606	Shoulder for up to 11 ft. 6 in. Arms	White		2
231921	Soffit Bracket Adapter	Cocoa	Extruded Aluminum	2
231721	Soffit Bracket Adapter	Latte	Extruded Aluminum	2
231821	Soffit Bracket Adapter	Sand	Extruded Aluminum	2
231621	Soffit Bracket Adapter	White	Extruded Aluminum	2
231982	Torsion Bar 16 ft.	Cocoa	Aluminum	1
231782	Torsion Bar 16 ft.	Latte	Aluminum	1
231882	Torsion Bar 16 ft.	Sand	Aluminum	1
231682	Torsion Bar 16 ft.	White	Aluminum	1
231983	Torsion Bar 20 ft.	Cocoa	Aluminum	1
231783	Torsion Bar 20 ft.	Latte	Aluminum	1
231883	Torsion Bar 20 ft.	Sand	Aluminum	1
231683	Torsion Bar 20 ft.	White	Aluminum	1
231984	Torsion Bar 24 ft.	Cocoa	Aluminum	1
231784	Torsion Bar 24 ft.	Latte	Aluminum	1
231884	Torsion Bar 24 ft.	Sand	Aluminum	1
231684	Torsion Bar 24 ft.	White	Aluminum	1
231653	Wall Bracket	Cocoa	Extruded Aluminum	2
231651	Wall Bracket	Latte	Extruded Aluminum	2
231652	Wall Bracket	Sand	Extruded Aluminum	2
231650	Wall Bracket	White	Extruded Aluminum	1
231923	XP System	Cocoa		2
231723	XP System	Latte		2
231823	XP System	Sand		2
231623	XP System	White		2

For ordering assistance, contact Trivantage customer service at 800.786.1876 or visit the online Solair Shade Solutions Extranet for order forms and pricing.



Solair® Comfort Retractable Awning

Add a new room to their house.

Your customers can enjoy their outdoor spaces like never before with Solair Comfort. They'll sit in cool comfort or bask in the sun with this easy-to-use, retractable awning. Add beauty to their home. Reduce their energy bills and protect their furniture against harmful UV rays. It's all possible with this affordable shade solution from the shade experts.

Standard Features

Frame: All aluminum frame components are electrostatic powder coated to provide a corrosion-resistant, high quality finish.

Arms: Arm control features double galvanized steel cables, wrapped in PVC for corrosion resistance and long life.

Hardware: Durable, die-cast arm construction.

Performance: Earned TUV Certification for its quality, durability and workmanship.

Front Bar: Front bar attachment has dual-action feature that increases flexibility and reduces strain on the awning during a wind gust.

Styling

Frame Colors: White and Latte.

Fabric Options: Hundreds of fabric choices from Sunbrella® and Dickson® brands.

Available Sizes

Widths: 11 feet 9 inches, 15 feet 6 inches, 19 feet 3 inches.

Projection: 10 feet 2 inches.

Motorized Operation

Optional motorized operation available and recommended for ease of use. Hand held remote included with motorized option. Allows awning operation with the touch of a button from 65 feet away.

Optional Features

Wireless Wind Sensor: Automatically retracts awnings upon detection of damaging winds.

Awning Assist Brace: Removable brace engineered to add support and stability to any Solair retractable awning.

Protective Hood: Protects fabric and motor while providing a finished look.

WARRANTY

10-year limited warranty on Sunbrella shade fabrics. 5-year limited warranty for specialty and decorative shade fabrics. 5-year warranty on Somfy motors. All warranties are good from the day of purchase. Complete warranties can be found online at Solair Shade Solutions Extranet.

Solair®, Sunbrella® and Dickson® are registered trademarks of Glen Raven, Inc.

Solair® Comfort Hood Kit

ITEM #	COLOR	STANDARD PACKAGE	WIDTH
276255	Latte	1	11 ft. 9 in.
276256	Latte	1	15 ft. 6 in.
276257	Latte	1	19 ft. 3 in.
276252	White	1	11 ft. 9 in.
276253	White	1	15 ft. 6 in.
276254	White	1	19 ft. 3 in.

Solair® is a registered trademark of Glen Raven, Inc.



231612

Solair® Comfort Components

ITEM #	DESCRIPTION	COLOR	STANDARD PACKAGE
231751	Arm 10 ft. 2 in.	Latte	1
231627	Arm 10 ft. 2 in.	White	1
275336	Beam Bracket		1
231752	Front Bar Attachment	Latte	1
231628	Front Bar Attachment	White	1
231753	Front Bar End Cap	Latte	1
231629	Front Bar End Cap	White	1
231755	Hood Bracket	Latte	1
231756	Hood Bracket	White	1
231758	Hood End Cap	Latte	1
231757	Hood End Cap	White	1
231750	Shoulder	Latte	1
231612	Shoulder	White	1
231754	Wall Bracket	Latte	1
231597	Wall Bracket	White	1

Solair® Accessories

ITEM #	DESCRIPTION	COLOR	MATERIAL	STANDARD PACKAGE
299545	Awning Assist Brace Kit	White		1
106805	Hand Brace 24 in.		Aluminum w/Wooden Handle	1
106800	Hand Brace 57 in.		Aluminum w/Wooden Handle	1
106801	Hand Brace 65 in.		Aluminum w/Wooden Handle	1
106802	Hand Brace 77 in.		Aluminum w/Wooden Handle	1
106803	Hand Brace 97 in.		Aluminum w/Wooden Handle	1
270399	Lock Fabric with Stainless Steel Screw			1
231696	Roof Mount Bracket 10 in.		Stainless Steel	1
231622	Roof Mount Bracket 12 in.		Stainless Steel	1
269869	Roof Mount Bracket 9 in.		Stainless Steel	1
225206	Spacer 1.75 in. x 0.50 in. Thick			1
225207	Spacer 1.75 in. x 0.75 in. Thick			1
225208	Spacer 1.75 in. x 1 in. Thick			1

Solair® is a registered trademark of Glen Raven, Inc.

Solair® Touch-Up Paint

A lacquer base, touch-up paint for Solair. Ideal for touching up small areas.

ITEM #	STYLE #	DESCRIPTION	COLOR	STANDARD PACKAGE
254139	RAL8017	0.6 oz. Brush Top Bottle	Cocoa	1
254137	RAL1019	0.6 oz. Brush Top Bottle	Latte	1
254138	RAL1013	0.6 oz. Brush Top Bottle	Sand	1
254136	RAL9010	0.6 oz. Brush Top Bottle	White	1
254133	RAL8017	12 oz. Aerosol Can	Cocoa	1
254131	RAL9019	12 oz. Aerosol Can	Latte	1
254132	RAL1013	12 oz. Aerosol Can	Sand	1
254130	RAL9010	12 oz. Aerosol Can	White	1

Solair® is a registered trademark of Glen Raven, Inc.



Solair® Power Screen

Revamp your customer's space with the click of a button so they can enjoy the outdoors on their terms. The Solair Power Screen transforms residential and commercial outdoor spaces into comfortable, ventilated, pest-free environments, protected from harmful UV rays. Motorized or manually operated, each Solair Power Screen is custom-designed and fabricated to fit the shape and design of the structure. When not in use, the screen retracts out-of-sight and blends stylishly with the building's exterior.

The SRS (Side Retention System) Power Screen is widely known as the highest performing screen system on the market today. The key to the superior functionality of the SRS is its fully retained fabric inside of aluminum side rails. The design creates a tight fit and long lasting performance.

With the increase in popularity of clear vinyl and fabric enclosures utilizing the Power Screen SRS, there are added precautions that you need to be aware of. When these screens are deployed, it is imperative someone observes the deployment of each screen (we do not recommend putting more than one screen per channel on a remote control). Operation in conditions in which wind and/or cold temperatures are present can result in the screen encountering a stall. Please consult your Trivantage sales representative on all clear vinyl and fabric enclosures.

Specially designed housing cassettes in two sizes allow product widths from 4ft to 18ft, and drops from 3ft to 11ft. Additional sizes may be available if needed. Consult your sales associate for additional information.

Offered in a variety of screening and shading options to suit your customer's needs.

When lowered in the summer months, Solair Power Screen fabrics will reduce air conditioning costs.

During cooler weather, the Solair Power Screen can be kept open to allow the sun's warmth to penetrate the interior.

Utilizing the latest technology, many Solair Power Screen fabrics are not only fire retardant, but industry leaders in puncture, tear and mildew resistance. Manufactured with the highest grade aluminum and nylon components, Solair Power Screens stand up to the toughest environments.

Power Screen frames are available in eleven colors: Black, Bronze, Brown, Desert Sand, Gray, Green, Tan, Navajo, Silver, White, Bright White. Custom colors are available at additional cost.

Motorized operation is recommended for all screen installations for quick deployment or retraction when needed. Motors offered are matched to the torque required based on fabric and frame weight.

WARRANTY 10-year limited frame warranty. Proper installation techniques must be followed to ensure long-term performance. Improper installation techniques will void warranty. Please consult your sales representative for installation guidelines.

Solair® is a registered trademark of Glen Raven, Inc.



Solair® Cable Curtain

Your customer can enjoy more time outdoors with the privacy and shade of the Solair Cable Curtain. When used as window shades, cable curtains can help reduce cooling costs and keep the heat outside the home. Perfect for both residential and commercial applications such as patios, gazebos and storefront settings.

Similar to the vertical curtain, the cable curtain includes a bottom bar, which connects to your choice of either 10 foot or 15 foot stainless steel side cables. The cables are supplied with cable clamps for securing cables to the floor or wall.

Standard Features

Frame: Made with electrostatic powder coated aluminum and galvanized steel components for a strong but light weight unit.

Winding Brace: Available in 24 inch, 57 inch, 65 inch (standard), 77 inch, or 97 inch.

Styling

Frame Colors: White, Sand and Cocoa.

Available Sizes

Frame kits are available in widths from 4 feet to 20 feet.

Motorized Operation

Optional motorized operation available and recommended for ease of use.

Optional Features

Remote Control: Allows you to operate curtain with the touch of a button from up to 65 feet away.

Protective Hood: Protects fabric and motor while providing a finished look.

WARRANTY Frame: 5-year warranty
 Motor: 5-year warranty

Solair® is a registered trademark of Glen Raven, Inc.



Solair® Vertical Curtain

The Solair Vertical Curtain provides an economical way to offer your customers a retractable vertical shade. These shades can reduce cooling costs and keep the heat outside the home. Perfect for both residential and commercial applications such as patios, gazebos and storefront settings. The system includes roller tube, gear, winding brace and mounting hardware.

Standard Features

Frame: Made with electrostatic powder coated aluminum and galvanized steel components for a strong but light weight unit.

Winding Brace: Available in 24 inch, 57 inch, 65 inch (standard), 77 inch, or 97 inch.

Styling

Frame Colors: White, Sand and Cocoa.

Available Sizes

Frame kits are available in widths from 4 feet to 20 feet.

Motorized Operation

Optional motorized operation available and recommended for ease of use.

Optional Features

Remote Control: Allows you to operate curtain with the touch of a button from up to 65 feet away.

Protective Hood: Protects fabric and motor while providing a finished look.

WARRANTY Frame: 5-year warranty
 Motor: 5-year warranty



Solair® Cable And Vertical Curtain Components

ITEM #	DESCRIPTION	COLOR	MATERIAL	STANDARD PACKAGE
231945	Bottom Bar 19 ft. 8 in.	Cocoa	Powder Coated Aluminum	1
231745	Bottom Bar 19 ft. 8 in.	Latte	Powder Coated Aluminum	1
231845	Bottom Bar 19 ft. 8 in.	Sand	Powder Coated Aluminum	1
231645	Bottom Bar 19 ft. 8 in.	White	Powder Coated Aluminum	1
231523	Bottom Bar Gudgeon	Black	Synthetic	1
231521	Cables 10 ft.		Stainless Steel	2
231522	Cables 15 ft.		Stainless Steel	2
231524	Curtain Cap with Lock 1.57" for 0.16 Cable			1
231940	Curtain Feet	Cocoa	Powder Coated Aluminum	2
231740	Curtain Feet	Latte	Powder Coated Aluminum	2
231840	Curtain Feet	Sand	Powder Coated Aluminum	2
231640	Curtain Feet	White	Powder Coated Aluminum	2
231939	End Bracket	Cocoa	Powder Coated Aluminum	2
231739	End Bracket	Latte	Powder Coated Aluminum	2
231839	End Bracket	Sand	Powder Coated Aluminum	2
231639	End Bracket	White	Powder Coated Aluminum	2
231937	End Brackets	Cocoa	Powder Coated Aluminum	2
231837	End Brackets	Sand	Powder Coated Aluminum	2
231637	End Brackets	White	Powder Coated Aluminum	2
231903	Gear 9:1	Cocoa		1
231803	Gear 9:1	Sand		1
231603	Gear 9:1	White		1
231944	Hood 20 ft.	Cocoa	Aluminum	1
231844	Hood 20 ft.	Sand	Aluminum	1
231644	Hood 20 ft.	White	Aluminum	1
231942	Hood Bracket	Cocoa	Powder Coated Steel	2
231842	Hood Bracket	Sand	Powder Coated Steel	2
231642	Hood Bracket	White	Powder Coated Steel	2
231943	Hood End Cap	Cocoa	Aluminum	2
231843	Hood End Cap	Sand	Aluminum	2
231643	Hood End Cap	White	Aluminum	2
231519	Pin Set			1
231518	Pinless Round Gudgeon 80 mm	Grey	Plastic	1
231507	Square Gudgeon 80 mm	Grey	Plastic	1

Solair® Patio Screens

Enjoy your outdoor space more often with a Solair Patio Screen. This economical vertical drop screen blocks wind and rain, eliminates glare and reduces radiant heat inside and outside of your home. Available in four frame colors and several screen options, this is the perfect shade and privacy solution for gazebos, pergolas, outdoor kitchens and many other outdoor living spaces.

The Solair Patio Screen can be used to reduce glare inside homes and buildings. The Solair Patio Screen with cable kit is recommended where light winds are common.

Standard Features

Frame: Made with two aluminum mounting brackets and galvanized steel roller tube and decorative aluminum weighted hem bar.

Styling

Frame Colors: White, Sand, Cocoa and Latte.

Available Sizes

Manufactured to the inch in widths ranging from 3' to 15' and drops from 3' to 15'.

Motorized Operation

Optional motorized operation available and recommended for ease of use.

Optional Features

Remote Control: Allows you to operate curtain with the touch of a button from up to 65 feet away.

Protective Hood: Protects fabric and motor while providing a finished look.

WARRANTY Frame: 5-year warranty
Motor: 5-year warranty

Solair® is a registered trademark of Glen Raven, Inc.



Solair® Maxi Window Awning

Make your customer’s home cooler and more stylish. The Solair window awning is a great investment in the beauty and value of a home or business. Adding a customized look to the outside, these shade solutions work to control the temperature and protect furniture and flooring against sun damage inside. Solair window awnings feature your choice of hundreds of fade-resistant and easy-to-clean fabrics, including brands like Sunbrella® and Dickson®, to customize any style of home. And thanks to design-inspired engineering using the highest quality materials and components, you will enjoy these shade solutions with little maintenance required.

The Solair Maxi window awning is recommended for use over large window spans where durability and strength are required. Available in four stock arm projections (2ft. 4in./ 3ft. 4in./ 4ft. 6in./ 5ft. 8in.) and made to order in custom widths from 6ft. to 20ft. Frame colors include white, sand and cocoa.

WARRANTY	5-year limited warranty on Solair Maxi framework. 10-year limited warranty on Sunbrella shade fabrics. 5-year limited warranty for specialty and decorative shade fabrics. 5-year warranty on Somfy motors. All warranties are good from the day of purchase. Complete warranties can be found online at Solair Shade Solutions Extranet.
-----------------	---

Solair®, Sunbrella® and Dickson® are registered trademarks of Glen Raven, Inc. Somfy® is a registered trademark of Somfy Systems, Inc.

Solair® Maxi Hood Kit

Kits include Maxi Hood, End Covers and Hood Brackets in quantity appropriate for specified kit width.

Available Sizes

Widths: Maxi Hood kits are made to order from 8ft to 20ft wide.

Available Colors

Cocoa

Sand

White

Solair® is a registered trademark of Glen Raven, Inc.

Solair® Maxi Awning Covers

Save fabrication time! We offer quality covers for the Solair Maxi window shade systems. Covers are offered in any standard pattern of Sunbrella® and Dickson® awning fabric. (Other fabric styles upon request.) Available with welded seams.

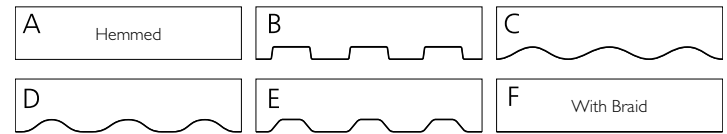

Solair®, Sunbrella® and Dickson® are registered trademarks of Glen Raven, Inc.

Solair® Maxi Components

ITEM #	DESCRIPTION	COLOR	MATERIAL	STANDARD PACKAGE
341742	Arm 2 ft. 4 in.	Cocoa		2
341762	Arm 2 ft. 4 in.	Latte		2
341722	Arm 2 ft. 4 in.	Sand		2
341743	Arm 3 ft. 4 in.	Cocoa		2
341763	Arm 3 ft. 4 in.	Latte		2
341723	Arm 3 ft. 4 in.	Sand		2
341703	Arm 3 ft. 4 in.	White		2
341744	Arm 4 ft. 6 in.	Cocoa		2
341764	Arm 4 ft. 6 in.	Latte		2
341724	Arm 4 ft. 6 in.	Sand		2
341704	Arm 4 ft. 6 in.	White		2
341745	Arm 5 ft. 8 in.	Cocoa		2
341765	Arm 5 ft. 8 in.	Latte		2
341725	Arm 5 ft. 8 in.	Sand		2
341705	Arm 5 ft. 8 in.	White		2
341750	End Bracket	Cocoa	Aluminum Die Cast	2
341770	End Bracket	Latte	Aluminum Die Cast	2
341730	End Bracket	Sand	Aluminum Die Cast	2
341710	End Bracket	White	Aluminum Die Cast	2
341752	Front Bar Ends Caps	Cocoa	Plastic	2
341772	Front Bar Ends Caps	Latte	Plastic	2
341732	Front Bar Ends Caps	Sand	Plastic	2
341712	Front Bar Ends Caps	White	Plastic	2
341749	Gear 9:1	Cocoa		1
341769	Gear 9:1	Latte		1
341729	Gear 9:1	Sand		1
341709	Gear 9:1	White		1
341755	Hood 22 ft.	Cocoa	Aluminum	1
341775	Hood 22 ft.	Latte	Aluminum	1
341735	Hood 22 ft.	Sand	Aluminum	1
341715	Hood 22 ft.	White	Aluminum	1
341753	Hood Bracket	Cocoa	Powder Coated Steel	2
341773	Hood Bracket	Latte	Powder Coated Steel	2
341733	Hood Bracket	Sand	Powder Coated Steel	2
341713	Hood Bracket	White	Powder Coated Steel	2
341754	Hood End Cap	Cocoa	Aluminum	2
341774	Hood End Cap	Latte	Aluminum	2

Somfy® Altus RTS Motor

WARRANTY	5-Year
-----------------	--------

ITEM #	STYLE #	DESCRIPTION	CABLE CORD LENGTH	STANDARD PACKAGE
274753	1043287	RTS Motor 525A2 LT50 with NEMA Plug	12 ft.	1
274751	1037501	RTS Motor 525S2 with NEMA Plug		1
274761	1037511	RTS Motor 550R2 with NEMA Plug	12 ft.	1
274031	9012145	RTS Motor Cable with NEMA Plug	12 ft.	1
274304	9012151	RTS Motor Cable with NEMA Plug	18 ft.	1
274006	9012146	RTS Motor Cable with NEMA Plug	24 ft.	1

Somfy® is a registered trademark of Somfy Systems, Inc.

ITEM #	DESCRIPTION	COLOR	MATERIAL	STANDARD PACKAGE
341734	Hood End Cap	Sand	Aluminum	2
341714	Hood End Cap	White	Aluminum	2

Solair® is a registered trademark of Glen Raven, Inc.



Somfy® Operators and Operator Options

These high-quality tubular motors and remote controls are designed to operate all Solair retractable awning systems. They provide the ultimate convenience in retractable awning operation. A remote control receiver is incorporated within the motor allowing the user remote control capability (no more electricians to hardwire the electronics). The receivers have a range up to 65 feet. All motors come standard with a power cord. Multiple lengths are available.

General Installation Requirements

The motor cable should not act as a direct conduit for water to enter the head of the motor. Note: Somfy motors conform to IP44 requirements and as such must be protected against direct weather elements such as rain, sleet, etc. In order to avoid water penetration, form a "drip loop" with the power cable and use a hood when required.

RTS Motor Installation Requirements

If the installation consists of multiple RTS motors, only one motor can be programmed at a time. All other motors must be disconnected. This will avoid interferences during the initial programming of each motor. The mounting distance between any two RTS motor heads should be no less than 19 inches, to avoid possible interference.

Use only Somfy RTS radio controls.

WARRANTY	5-Year
-----------------	--------

ITEM #	STYLE #	DESCRIPTION	COLOR	STANDARD PACKAGE
274499	1810639	1-Channel Transmitter	Silver	1
276645	1810650	Telis 1-Channel RTS Lounge Transmitter		1
274553	1810643	Telis 1-Channel RTS Patio Transmitter	Blue/White	1
274552	1810632	Telis 1-Channel RTS Pure Transmitter		1
276650	1811082	Telis 16-Channel RTS Transmitter	Silver	1
275019	1810652	Telis 4 5-Channel RTS Lounge Transmitter		1
274551	1810645	Telis 4 5-Channel RTS Patio Transmitter	Blue/White	1
274550	1810633	Telis 4 5-Channel RTS Pure Transmitter		1
274498	1810641	Telis 4 5-Channel Transmitter	Silver	1
274571	1811243	Telis Soliris 4 5-Channel RTS Patio Transmitter	Blue/White	1
274547	1810635	Telis Soliris RTS Pure Transmitter		1

Somfy® is a registered trademark of Somfy Systems, Inc.

SUNEA RTS CMO VISUAL REFERENCE GUIDE

STANDARD AWNING SETTINGS:

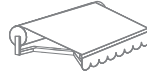

Both UP and DOWN limits need to be set.

Before You Begin:

Make sure the DOWN button on the remote extends the awning. (▼ = awning moves outward or extends). Failure to correct this may cause damage to the awning or personal injury.



STEP 1

Initiate programming by pressing both the ▲ (Up) and ▼ (Down) buttons at the same time until the motor jogs.



STEP 2

Check the direction of operation. Press and hold the ▼ button and confirm it moves the motor out. To change the direction press and hold the my (Stop) button until the motor jogs.

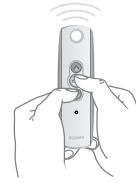

STEP 3

Bring the motor to your desired upper limit by pressing the ▲ button. Press and hold both the my and ▼ buttons until the motor begins to move down, then release. Use the my button to stop it at the desired lower limit



STEP 4

Press the my and ▲ button until the motor begins to move up. the motor will stop at the original upper point.



STEP 5

Press and hold the my button until the motor jogs



STEP 6

Press and hold the Program button on the back of the transmitter until the motor jogs. Double check limits as a precaution.

ADJUSTING THE LIMITS

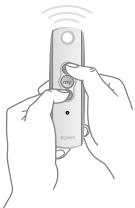

To change the lower limit:

Move the motor to its current lower limit position and let it stop. Press and hold the ▲ and ▼ buttons simultaneously until the motor jogs, then release. Adjust to a new lower limit position. Press the my button until the motor jogs, then release. Check new limit.

To change the upper limit:

Move the motor to its current upper limit position and let it stop. Press and hold the ▲ and ▼ buttons simultaneously until the motor jogs, then release. Adjust to a new upper limit position. Press the my button until the motor jogs, then release. Check new limit.

To add a remote/channel or sun and wind sensor:

First press the programming button on the back of the already programmed remote until the motor jogs. Then press the programming button on the remote or sun/wind sensor that you would like to add until the motor jogs. Check it.



To reset the motor:

you will need to disconnect power (120vac) for 2 seconds, reconnect for 10 seconds, disconnect for another 2 seconds and reconnect. The motor should start to move or jog (If this does not happen, continue to perform the disconnects until it does). Once the motor stops, press and hold the programming button on the back of the remote and count to ten without letting go. The motor should jog twice.

ADVANCED FEATURE FUNCTIONS

BACK IMPULSE function for both cassette and standard awnings

This function allows you to apply tension on the fabric when the awning is fully extended. The motor can be adjusted up to a ½ half turn.

STEP 1
Disconnect power momentarily and reconnect.

STEP 2
Set the awning to the lowest position.



STEP 3
Press the MY and Up buttons until the awning jogs: The motor is in programming mode.



STEP 4
Adjust the fabric's tension using the Up or Down buttons.



STEP 5
Press the MY button until the awning jogs: The fabric's tension has been programmed.



SOMFY SYSTEMS, INC.
1-800-22SOMFY

SOMFY CANADA
1-905-564-6446

WWW.SOMFYSYSTEMS.COM

L-0138





Somfy Sunea RTS CMO Motor with Extension Cord with NEMA Plug

Somfy® Sunea RTS CMO Motor

The Sunea RTS CMO motor, which is used most often in our Solair Pro retractable awning, features easy limit-setting via transmitter, torque sensing capabilities, back release function, back impulse function setting, manual override, built-in Radio Technology Somfy (RTS), and a convenient 18 inch fast connector cable to adapt to various cable lengths. The Sunea RTS CMO is compatible with Somfy's entire collection of RTS controls including hand-held remotes, wall switches, timers, sensors and outdoor heaters.

WARRANTY		5-Year		
ITEM #	STYLE #	DESCRIPTION	CABLE CORD LENGTH	STANDARD PACKAGE
274577	9015977	RTS CMO Extension Cord with NEMA Plug	18 ft.	1
274578	9015784	RTS CMO Extension Cord with NEMA Plug	24 ft.	1
274576	9015783	RTS CMO Extension Cord with NEMA Plug	12 ft.	1
273920	1114230	RTS CMO Motor 525A2		1
273922	1118167	RTS CMO Motor 550R2		1
274580	9015989	RTS CMO Override Kit		1

Somfy® is a registered trademark of Somfy Systems, Inc.

Somfy® CMO Motor

The Somfy Compact Manual Override (CMO) Motor provides an added safety feature in the event of a power failure. Anyone can easily operate the crank handle as the reduction ratio allows for quick and easy operation. With the new rapid limit switch, all that is required to set the length of travel is a simple touch adjustment.

Features

Compact Design: Requires minimum installation space (1.0 in. – 24 mm).

Ease of Operation: Minimum effort required for crank operation.

Tested Reliability: Meets UL and CSA standards.

WARRANTY		5-Year		
ITEM #	STYLE #	DESCRIPTION	CABLE CORD LENGTH	STANDARD PACKAGE
274126	9012349	CMO Motor Override Kit (Metric)		1
274131	9685114	CMO Motor Override Shaft 60 mm		1
273942	9077287	CMO Motor Override Shaft with Eye 100 mm		1
274740		RTS CMO Motor 525A2 with NEMA Plug	12 ft.	1
274032	9012148	RTS CMO Motor Cable with NEMA Plug	12 ft.	1
274122	9012149	RTS CMO Motor Cable with NEMA Plug	24 ft.	1
274306	9012150	RTS CMO Motor Cable with NEMA Plug	18 ft.	1

Somfy® is a registered trademark of Somfy Systems, Inc.

Somfy® Motor Hardware

WARRANTY		5-Year		
ITEM #	STYLE #	DESCRIPTION		STANDARD PACKAGE
270531	9707027	Crown for LT50 DS78		1
270547	9707639	Crown for LT60 DS78/D		1
273971	9012241	Drive Mod DS78		1
273968	9910001	Universal Bracket with Spring Ring (Metric)		1

Somfy® is a registered trademark of Somfy Systems, Inc.



SIMU® Solar AutoSun™ Solar Power Operator

The AutoSun Motor System from Simu uses the power of the sun to effortlessly retract Solair window awnings, roller shutters, screens, awning front valances and RV awnings.

By tapping the power of the sun, the AutoSun system uses only clean, renewable and free energy. First, the system collects solar energy through its solar panel. Then, the energy is transmitted from the solar panel to a battery. The DC motor is then powered by the battery and is controlled by an integrated SIMU-Hz radio control and electronic limits.

Using advanced technology, this solar powered system also detects frost and obstacles for worry free operation when mounted in rolling shutters. AutoSun is also quick and easy to install. It requires no power supply cables, no holes to be drilled and no electrician is necessary.

Operation is simple. The battery features an easy access button to reset the motor. And thanks to built in radio technology, the end limit distance settings can be personalized with four different possibilities using the remote.

WARRANTY		5-Year	
ITEM #	STYLE #	DESCRIPTION	STANDARD PACKAGE
276651	2007000	AutoSun 10Nm Motor System	1
274557	9014734	AutoSun Battery	1
274558	2006996	AutoSun Motor System	1

SIMU® is a registered trademark of SIMU France.

Somfy® Ondeis™ WireFree RTS Rain and Sun Sensor

The Ondeis Wirefree sensor is a solar-powered combined rain and sun sensor compatible with Radio Technology Somfy (RTS) motorized exterior products, including awnings, rolling shutters and screens. The sensor uses optical rain-sensing technology to measure rainfall and sends an RTS command when rainfall exceeds the user-selected threshold. It also utilizes a sun-level sensor that sends an RTS command when sunlight exceeds the user-selected threshold.

Somfy Soliris transmitter (not included) is required to activate the motor's sun function.

WARRANTY		5-Year
ITEM #	STYLE #	STANDARD PACKAGE
274421	9019617	1

Somfy® is a registered trademark of Somfy Systems, Inc. Ondeis™ is a trademark of Somfy Systems, Inc.

Somfy® Eolis Wind Sensor Kit

The Eolis Wind Sensor includes an integrated radio receiver. Wind speed is continuously monitored, triggering the control to retract awnings automatically as needed. The Eolis can operate the controls individually or in groups using Telis Transmitters.

WARRANTY		5-Year		
ITEM #	STYLE #	DESCRIPTION	COLOR	STANDARD PACKAGE
274401	9013847	3D WireFree RTS Wind Sensor	Black	1
274400	1816083	3D WireFree RTS Wind Sensor	Off-White	1
274395	1816081	3D WireFree RTS Wind Sensor	White	1
274275	9012499	RTS Wind Sensor Kit 24V DC		1

Somfy® is a registered trademark of Somfy Systems, Inc.



Somfy® Soliris Sensor

This radio remote-controlled receiver provides dependable and automatic protection based on sun and wind levels. The Soliris Sensor automatically retracts a motorized awning when it senses high winds and opens in intense sunlight. The Soliris Sensor provides electronic ease and complete climate control, for the ultimate in awning protection and convenience.

Somfy Soliris transmitter (not included) is required to activate the motor's sun function.

WARRANTY		5-Year	
ITEM #	STYLE #	DESCRIPTION	STANDARD PACKAGE
274277	9012500	RTS Wind/Sun Sensor Kit	1

Somfy® is a registered trademark of Somfy Systems, Inc.

Somfy® Universal RTS Receiver

The Somfy Universal RTS Receiver provides RTS capability to Somfy's standard (non-RTS) motors. It can be used as a stand-alone radio control, or with Somfy's RTS sensor for sun and wind control. One user-defined intermediate stop-position can be programmed. This 110V control is packaged in a weatherproof enclosure and includes watertight strain-relief fittings for wires entering the box.

WARRANTY	5-Year
-----------------	--------

ITEM #	STYLE #	DESCRIPTION	STANDARD PACKAGE
274510	1810627	Universal RTS Receiver	1

Somfy® is a registered trademark of Somfy Systems, Inc.

Somfy® myLink™

The myLink™ RTS Smartphone and Tablet Interface is a WiFi to Radio Technology Somfy® bridge that can control up to 5 channels of RTS motorized products using the Somfy myLink apps for iOS and Android devices. Through the app, users can send immediate RTS commands, create Scenes (a group of motorized products working together) and Schedules (timed events). Users may access their myLinks from anywhere with the app's remote access feature. Though the myLink is a single-zone controller, multiple myLinks can be joined within the same system for multi-zone control.

WARRANTY	5-Year
-----------------	--------

ITEM #	STYLE #	STANDARD PACKAGE
270400	1811403	1

Somfy® is a registered trademark of Somfy Systems, Inc. myLink™ is a trademark of Somfy Systems, Inc.

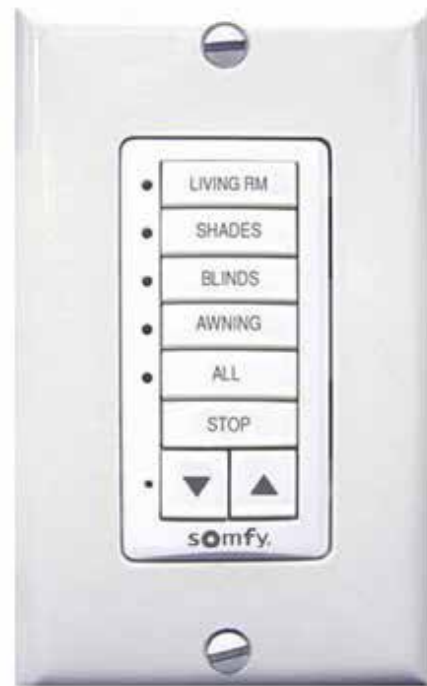

DecoFlex WireFree™ RTS

The DecoFlex WireFree RTS battery powered wall switch features Radio Technology Somfy (RTS) and may be personalized for intuitive control of window coverings such as shades, blinds, draperies, rolling shutters and awnings. It is available fully assembled in one and five channel button versions or may be easily converted to a two, three or four channel button switch. Choose from three colors – white, ivory or black – to match any decor. The switch is designed to complement the full range of Somfy RTS handheld transmitters, timers and interfaces.

Installation is quick and simple, with no wiring required. Included with each switch is an extended life lithium battery eliminating the need for an electrician. The DecoFlex WireFree RTS may be installed independently or next to an existing light switch using the included wall mounting bracket and the appropriate wall plate.

WARRANTY	5-Year
-----------------	--------

ITEM #	STYLE #	DESCRIPTION	COLOR	STANDARD PACKAGE
275105	1810898	1-Channel WireFree RTS	Ivory	1
275104	1810897	1-Channel WireFree RTS	White	1
274991	61114025	2-Channel Face Plate	Ivory	1
274990	61114024	2-Channel Face Plate	White	1
274994	61114034	3-Channel Face Plate	Ivory	1
274993	61114033	3-Channel Face Plate	White	1
274997	61114044	4-Channel Face Plate	Ivory	1
274996	61114043	4-Channel Face Plate	White	1
275107	1810814	5-Channel WireFree RTS	Ivory	1
275106	1810813	5-Channel WireFree RTS	White	1

Somfy® is a registered trademark of Somfy Systems, Inc.



Somfy® Infrared Heater

The new Somfy Infrared Heater with RTS receiver is a 1500 watt heater that enables your customers to spend more time enjoying their awning and outdoor living space. Equipped with Somfy's exclusive RTS technology, users can control the heater with the same remote they use to control their awning. This weatherproof infrared heater is environmentally friendly and energy efficient by providing instant heat to warm people, not the air, and has a lower running cost than gas heaters. Provides heat up to 1300 square feet (13 feet x 10 feet) or approximately an area equivalent to a table with five chairs.

WARRANTY		5-Year		
ITEM #	STYLE #	DESCRIPTION	COLOR	STANDARD PACKAGE
273902	1824018	RTS 1500-Watt Infrared Heater	White	1
273903	9015148	RTS Heater Mounting Bracket		1

Somfy® is a registered trademark of Somfy Systems, Inc.

Shade Inspiration Collection™ Sales MaterialsShade Inspiration Collection™ Sales Materials

For ordering assistance, contact Trivantage customer service at 800.786.1876 or visit the online Solair Shade Solutions Extranet for order forms and pricing.

RollEase® Roller Shade System

Patented, manually operated clutch mechanism. Easy to fabricate and install. Clutch automatically locks, holding shade securely in place. Adjacent shades are easily set to matching levels. Shades stay clean, you never have to touch the fabric.

Not intended for outdoor applications.

ITEM #	DESCRIPTION	COLOR	DIAMETER	LENGTH	MATERIAL	SIZE	STANDARD PACKAGE
224521	Chain Stop Ball					5/16 in.	100
224514	Clutch R-16	Black	1-1/2 in.				1
224516	Clutch R-16	Vanilla	1-1/2 in.				1
224598	Clutch R-16	White	1.5 in.				1
224517	Clutch R-24	Vanilla	1-1/2 in.				1
224518	Clutch R-8	Black	1-1/2 in.				1
224555	Clutch R-8	Black	1-1/4 in.				1
224515	Clutch R-8	Vanilla	1-1/4 in.				1
224519	Clutch R-C14	Vanilla	1-1/2 in.				1
224591	Clutch/End Plug Conversion Adapter	Black				1-1/2 in. to 2 in.	1
224592	Clutch/End Plug Conversion Adapter	Vanilla				1-1/2 in. to 2 in.	1
224486	End Plug		1-1/2 in.				1
224512	End Plug	Black	1-1/2 in.				1
224556	End Plug	Black	1-1/4 in.				1
224511	End Plug	Vanilla	1-1/2 in.				1
224510	End Plug	Vanilla	1-1/4 in.				1
224547	Exterior Clutch R-24	Black	1-1/2 in.				1
224620	Exterior Clutch R-8	Vanilla	1.5 in.				1
224587	Exterior Hem Bar	Anodized Aluminum		12 ft.			288
224645	Exterior Hem Bar	Anodized Aluminum		16 ft.			160
224589	Exterior Hem Bar	Black		12 ft.			288
224646	Exterior Hem Bar	Black		16 ft.			160
224586	Exterior Hem Bar	Dark Bronze		12 ft.			288
224644	Exterior Hem Bar	Dark Bronze		16 ft.			160
224584	Exterior Hem Bar	Vanilla		12 ft.			288
224642	Exterior Hem Bar	Vanilla		16 ft.			160
224585	Exterior Hem Bar	White		12 ft.			288
224643	Exterior Hem Bar	White		16 ft.			160
224580	External Hem Bar Strip			300 ft.			1
224574	Fascia Bracket for R-16 Clutch	Black				3 in.	1
224570	Fascia Bracket for R-16 Clutch	Bronze				3 in.	1
224571	Fascia Bracket for R-16 Clutch	Vanilla				3 in.	1
224572	Fascia Bracket for R-16 Clutch	White				3 in.	1
224577	Fascia Bracket for R-24 Clutch	Bronze				4 in.	1
224564	Fascia Bracket for R-24 Clutch	Vanilla				4 in.	1
224576	Fascia Bracket for R-24 Clutch	White				4 in.	1
224560	Fascia Bracket for R-8 Clutch	Bronze				3 in.	1
224561	Fascia Bracket for R-8 Clutch	Vanilla				3 in.	1
224562	Fascia Bracket for R-8 Clutch	White				3 in.	1
224553	Fascia	Anodized Aluminum				3 in. x 12 ft.	12
224528	Fascia	Anodized Aluminum				3 in. x 16 ft.	10
224566	Fascia	Anodized Aluminum				4 in. x 12 ft.	12
224632	Fascia	Anodized Aluminum				4 in. x 16 ft.	1
224554	Fascia	Black				3 in. x 12 ft.	12
224558	Fascia	Black				3 in. x 16 ft.	12

ITEM #	DESCRIPTION	COLOR	DIAMETER	LENGTH	MATERIAL	SIZE	STANDARD PACKAGE
224565	Fascia	Black				4 in. x 12 ft.	12
224631	Fascia	Black				4 in. x 16 ft.	12
224550	Fascia	Bronze				3 in. x 12 ft.	12
224500	Fascia	Bronze				3 in. x 16 ft.	16
224568	Fascia	Bronze				4 in. x 12 ft.	12
224640	Fascia	Bronze				4 in. x 16 ft.	1
224551	Fascia	Vanilla				3 in. x 12 ft.	12
224501	Fascia	Vanilla				3 in. x 16 ft.	10
224569	Fascia	Vanilla				4 in. x 12 ft.	12
224641	Fascia	Vanilla				4 in. x 16 ft.	1
224552	Fascia	White				3 in. x 12 ft.	12
224508	Fascia	White				3 in. x 16 ft.	10
224567	Fascia	White				4 in. x 12 ft.	12
224633	Fascia	White				4 in. x 16 ft.	1
224582	Hem Bar End Cap with Screw	Black					100
224588	Hem Bar End Cap with Screw	Vanilla					100
224581	Hem Bar End Cap with Screw	White					100
224648	Interior Clutch R-24	Black	1.5 in.				1
224686	Internal Hem Bar			16 ft.			16
224544	Metal Chain Connector						1
224525	Metal Chain with Safety Warning Tag			4 ft.			1
224526	Metal Chain with Safety Warning Tag			5 ft.			1
224527	Metal Chain with Safety Warning Tag			6 ft.			1
224520	Metal Chain with Safety Warning Tags			500 ft.			1
224507	Mounting Bracket Cover for R-8 Clutch	White					1
224506	Mounting Bracket for R-16 Clutch 1-1/2 in.				Nickel		1
224524	Mounting Bracket for R-16, R-24 Clutch 2 in.				Nickel		1
224505	Mounting Bracket for R-3, R-8 Clutch 1-1/2 in.				Nickel		1
224509	Mounting Bracket for R-3, R-8 Clutch 2 in.				Nickel		1
224541	Plastic Chain Connector	Black					100
224539	Plastic Chain Connector	Clear					100
224542	Plastic Chain Connector	Vanilla					100
224540	Plastic Chain Connector	White					100
224531	Plastic Chain with Safety Warning Tags	Black		100 ft.			1
224536	Plastic Chain with Safety Warning Tags	Black		820 ft.			1
224533	Plastic Chain with Safety Warning Tags	Brown		820 ft.			1
224532	Plastic Chain with Safety Warning Tags	Vanilla		100 ft.			1
224537	Plastic Chain with Safety Warning Tags	Vanilla		820 ft.			1
224530	Plastic Chain with Safety Warning Tags	White		100 ft.			1
224535	Plastic Chain with Safety Warning Tags	White		820 ft.			1
224634	Plastic Chain	Vanilla		820 ft.			1
224504	Roller Tube Taped				Aluminum	1-1/2 in. x 12 ft.	96
224503	Roller Tube Taped				Aluminum	1-1/4 in. x 12 ft.	120
224627	Roller Tube Taped				Aluminum	2 in. x 12 ft.	48
224628	Roller Tube Taped				Aluminum	2 in. x 16 ft.	64
224649	SafetyHold3	Clear					1

RollEase® is a registered trademark of RollEase, Inc.

RollEase Roller Shade – Selecting Clutch and Tube Sizes

Shade Height (In.)

Fabric Weight (Oz. Per Yd.)

18 Oz. 12 Oz. 6 Oz.

Shade Width (In.)

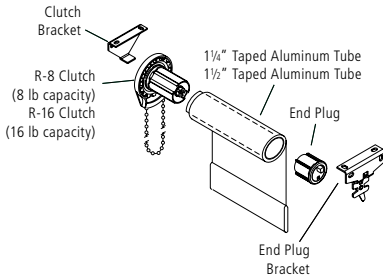
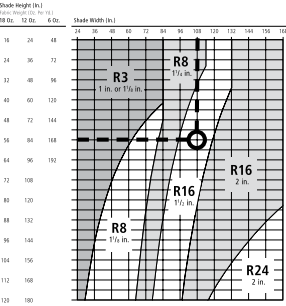
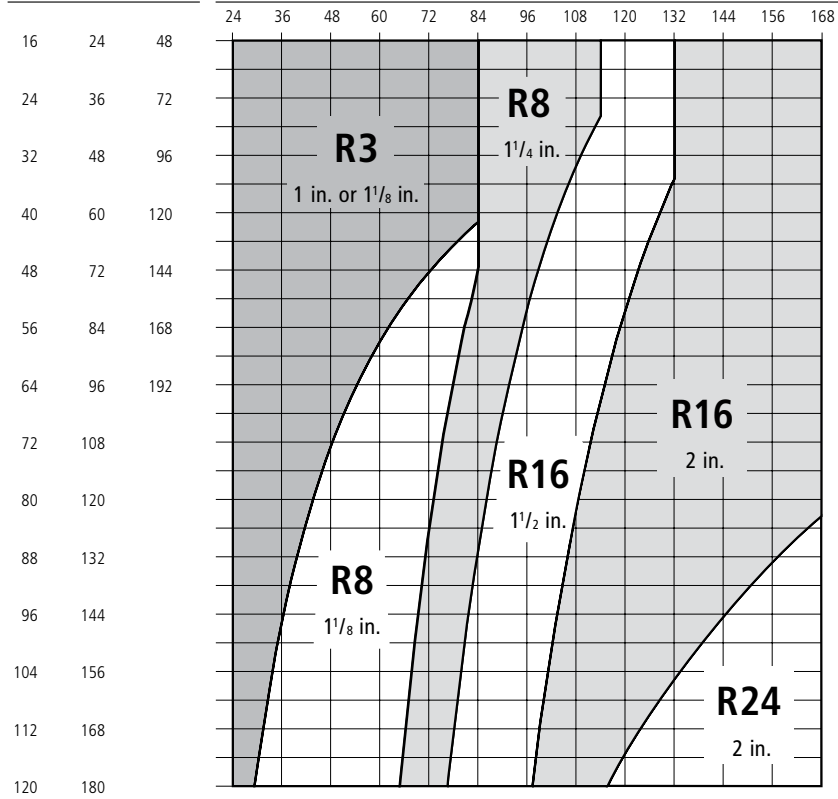

1. IN THE LEFT HALF OF THE CHART, find the column appropriate for the shade's fabric. Read down that column until you reach the approximate height of the shade.
2. FOLLOW STRAIGHT ACROSS to the right half of the chart, as far as the vertical line that represents the shade's width.
3. THE CLUTCH AND TUBE SIZES SHOWN ARE THE MINIMUM you may use for that shade. You may, of course, use a heavier clutch or a larger tube. But using a lighter clutch might lead to clutch failure. Using a smaller tube might lead to bowing of the tube.

Example: What is the smallest clutch-and-tube combination for a 12 oz. shade that is 100 in. wide and 84 in. tall? The arrows (in the small chart below) that start from height = 84 in. and width = 100 in. show this to be an R16 clutch in 1 1/2 in. tube

For ordering assistance, contact Trivantage customer service at 800.786.1876 or visit the online Solair Shade Solutions Extranet for order forms and pricing.

Somfy® Motors and Accessories for Interior Shades – R28 Motor

The Somfy® R28 motor is the perfect solution for hard-to-reach window coverings. Designed for roller/solar shades, sheer horizontals, Roman and woven wood shades. Battery powered. Installs in minutes.

WARRANTY	5-Year
-----------------	--------

ITEM #	STYLE #	DESCRIPTION	STANDARD PACKAGE
276715	9018475	Crown for 1-1/2 in. RollEase Tube	1
276596	9018474	Crown for 1-1/4 in. RollEase Tube	1
276716	9018477	Drive for 1-1/2 in. RollEase Tube	1
276597	9018476	Drive for 1-1/4 in. RollEase Tube	1
276593	1002481	RTS Motor R28-12v	1
276713	9019235	Solar Pack WireFree Kit with Battery Pack	1

RollEase® is a registered trademark of RollEase, Inc. Somfy® is a registered trademark of Somfy Systems, Inc.



274344

Somfy® Motors and Accessories for Interior Shades

Motorization for 1-1/4 inch and 1-1/2 inch RollEase® Roller Tube. Deductions for motorized operation are 1-1/8 inches.

WARRANTY	5-Year
-----------------	--------

ITEM #	STYLE #	DESCRIPTION	STANDARD PACKAGE
274344	9013488	1-1/2 in. Crown and Drive Set	1
270597	1781148	Aluminum Roller Tube 2 in. x 20 ft.	100
275064	1030066	Sonesse RH RTS Motor 504S2	1
275063	1030065	Sonesse RTS Motor 504S2 with Hardwire Cable	1
274546	1810647	Telis Soliris RTS Patio Transmitter	1
274799	1822192	Transformer Plug-In 12v DC with 25 ft. Cable	1
276675	9016374	Y-Harness Extension Cable 2 ft.	1

RollEase® is a registered trademark of RollEase, Inc. Somfy® is a registered trademark of Somfy Systems, Inc.



276604

Somfy® Motors and Accessories for Interior Shades – ST30 Motor

Motorization for 1-1/2 inch RollEase® Roller Tube using Somfy ST30 Sonesse Motor. Deductions for motorized operation are 1-1/8 inches.

WARRANTY	5-Year
-----------------	--------

ITEM #	STYLE #	DESCRIPTION	STANDARD PACKAGE
276619	9013775	Crown and Drive Set 1-1/2 in.	1
276604	1822209	Transformer 24v 1.25A DC Wall Mount Plug-In with 10 ft. Cable	1

RollEase® is a registered trademark of RollEase, Inc. Somfy® is a registered trademark of Somfy Systems, Inc.

Somfy® Home Automation

WARRANTY	5-Year
-----------------	--------

ITEM #	STYLE #	DESCRIPTION	STANDARD PACKAGE
275033	1810791	RTS Repeater and Range Expander 120VAC 60Hz	1
275032	1810872	Universal RTS Interface II 16-Channel	1

Somfy® is a registered trademark of Somfy Systems, Inc.



212502

HH-66 Vinyl Cement

Easily and quickly applied, this cement provides a fast drying and exceptionally strong bond to all types of vinyl coated fabrics, plastics, metals, glass, wood and leather. It can also be used for sealing or waterproofing seams.

ITEM #	FABRIC	PUT UP	STANDARD PACKAGE
212498	Vinyl Coated	5 gal. can	1
212500	Vinyl Coated	8 oz. brushtop can	12
212502	Vinyl Coated	1 qt. brushtop can	12
212503	Vinyl Coated	1 gal. can	6
212504	Vinyl Coated	1 pt. brushtop can	12
212505	Vinyl Coated	4 oz. brushtop can	12

HH-66 Vinyl Cement Thinner

ITEM #	FABRIC	PUT UP	STANDARD PACKAGE
214326	Vinyl Coated	1 pt. can	1



230099

Clearco 444

Excellent foam to foam, foam to fabric adhesive. Clearco 444 Spray Adhesive provides a clear web pattern ideal for porous and rough surfaces. Example: use when you need adhesive spray for upholstery, polyurethane foam, foam mattress, marine upholstery, urethane foam, polystyrene foam, fiberglass, polyurethane carpet, extruded polystyrene, polypropylene, water-white adhesive spray, lace spray pattern adhesive, low soak-in adhesive spray, asbestos abatement adhesive spray. Clearco 444 meets California VOC compliancy.

ITEM #	STYLE #	PUT UP	STANDARD PACKAGE
230099	444	12 oz. aerosol can	12



212402

HAR Adhesive – 628 For Bonding Neoprene Coated Fabrics

A fast-drying, solvent based contact bond adhesive possessing unusually high strength and outstanding high and low temperature resistance in addition to excellent water, oil, grease, chemical and weather resistance. While primarily designed for bonding Neoprene and Hypalon-coated fabrics, acrylic and canvas, this versatile adhesive may be used for bonding a wide variety of synthetic fabrics, rubber stocks, leather, rigid plastics, metals, wood, hardboard and many other porous and non-porous materials. Adhesive 628 applies easily with a brush, roller, trowel, or spray gun. One gallon covers approximately 250 to 300 square feet of surface area. Adhesive can be thinned with MEK or Acetone.

ITEM #	PUT UP	STANDARD PACKAGE
212402	1 pt. brushtop can	24

Subject to special handling charge by shippers. ICC Shipping Classification: Adhesive Cements, NOIBN, flammable liquid.

HAR Adhesive – 728 For Bonding Vinyl To Vinyl

A medium, fast-drying solvent-based synthetic resin adhesive designed primarily for bonding supported or unsupported vinyl fabric to itself or to various porous and non-porous materials. This cement is not recommended for laminates. (Adhesive 730 should be used for vinyl laminated fabrics.) Adhesive 728 may also be used for bonding polyurethane, canvas, synthetic fabrics, leather, metals, wood, glass, rigid plastics and some foams. Adhesive 728 applies easily with a brush, roller or spray gun. Adhesive 728 can be used on tarpaulins, awnings, tents, covers, drop cloths, liners, tops, textile bags and in truck and boat repair kits. One gallon covers approximately 250 to 300 square feet of surface area. Adhesive can be thinned with MEK or Acetone.

ITEM #	PUT UP	STANDARD PACKAGE
212411	4 oz. brushtop can	24
212412	1 pt. brushtop can	24
212414	1 qt. can	6

Subject to special handling charge by shippers. ICC Shipping Classification: Adhesive Cements, NOIBN, flammable liquid.

HAR Adhesive – 730 For Bonding Vinyl-Laminated Fabrics

A fast-drying, solvent-based synthetic resin adhesive primarily designed for bonding laminated vinyl fabrics. Adhesive 730 may also be used for bonding vinyl-coated fabrics, polyurethane coated fabrics, many synthetic fabrics, canvas, leather, wood, metals, glass and various other products. Adhesive 730 under normal conditions of use will not blister or delaminate laminated vinyl fabrics. Adhesive 730 dried films are tough, flexible, clear, colorless, glossy and non-tacky. Adhesive 730 films are resistant to water, fuels, oils, greases, plasticizers, chemicals and weathering. Adhesive 730 applies easily using a brush, roller or spray gun. The shelf life of Adhesive 730 exceeds one year under normal storage conditions.

Adhesive 730 can be used in the manufacture and repair of tarpaulins, covers, awnings, tents, tops, dropcloths, liners, textile bags, and in boat, truck and pool repair kits. Adhesive can be thinned with MEK or Acetone.

ITEM #	PUT UP	STANDARD PACKAGE
212420	4 oz. brushtop can	24
212421	1 pt. brushtop can	24

Subject to special handling charge by shippers. ICC Shipping Classification: Adhesive Cements, NOIBN, flammable liquid.

HAR Adhesive – 740 For Cotton Ducks

A quick-drying (1 hour) adhesive for bonding and repairing various cotton ducks. Apply to one surface only, using paddle or knife. Patch is flexible after drying; some absorption by fabric.

ITEM #	PUT UP	STANDARD PACKAGE
212430	4 oz. brushtop can	24
212431	1 pt. brushtop can	24

Subject to special handling charge by shippers. ICC Shipping Classification: Adhesive Cements, NOIBN, flammable liquid.

HAR Adhesive – 729 Vinyl Seam Sealer

A fast-drying solvent-based synthetic resin adhesive primarily designed for sealing stitched seams on vinyl-coated and laminated fabrics, and many other fabrics. Dried films of Adhesive 729 will show no tackiness up to temperatures over 140° F and will retain flexibility at very low temperatures. Adhesive 729 can be easily applied using a brush, roller or spray gun. One gallon covers approximately 250 to 300 sq. ft. of surface area. Adhesive can be thinned with MEK or Acetone.

ITEM #	PUT UP	STANDARD PACKAGE
265801	4 oz. brushtop can	24
265804	1 qt. can	6

Subject to special handling charge by shippers. ICC Shipping Classification: Adhesive Cements, NOIBN, flammable liquid.



214334

VLP® Vinyl Liquid Patch

An excellent adhesive for repairing pinholes, rips, tears, cuts, etc., on all types of vinyl. Available in 1 ounce tubes.

ITEM #	PUT UP	STANDARD PACKAGE
214334	1 oz. tube	1

VLP® is a registered trademark of Plasti Dip International.



214362

IOSSO® Seam Sealer

IOSSO Seam Sealer prevents most seams from leaking. Best for use on cotton, cotton blends, polyester and synthetic woven fabrics. Water repellency will vary with vinyl coated and vinyl laminated fabrics due to seam construction. It will not change the look or feel of the fabric. Ideal for boat covers, awnings, tents and backpacks.

ITEM #	STYLE #	PUT UP	STANDARD PACKAGE
214200	10920	4 oz.	12
214362	10921	1 gal.	1

IOSSO® is a registered trademark of IOSSO Products, Inc.



212006

Tear Mender

Mends instantly. Waterproof. Mends and repairs canvas, tarps, awnings, acrylic material, leather goods, work clothing, and any other material it can penetrate. UV resistant. Contains no harsh or harmful chemicals. Manufactured for a 2-year shelf life.

ITEM #	STYLE #	PUT UP	STANDARD PACKAGE
212005	TM-1	2 oz.	12
212006	TG-6H	6 oz.	12
212007	TG-16	16 oz.	12
212011	TG-128	1 gal.	1
212012	TG-640	5 gal.	1

Tear Mender can be shipped via regular UPS – no hazardous handling fee required. Not shipped when temperatures are below freezing (32° F).



212041



212040

Tear-Aid® Patch Retail Kits

Made from an exceptionally tough, matte finish, abrasion resistant, polyurethane elastomer that resists puncture and tearing. It is combined with an aggressive adhesive formulated for high bond strength to a variety of surfaces. Holds air, holds water, won't pull off when stretched, see-thru patch, UV resistant, conforms to irregular surfaces, cuts easily with scissors, and won't turn gummy in high heat.

Type A Repairs: Canvas, most fabrics, rubber, neoprene, most plastics, nylon, fiberglass, stainless steel, aluminum, polyethylene, polypropylene, polyurethane, non-oiled leather, Sunbrella®.

Type B Repairs: Vinyl and vinyl-coated materials. Has a new, unique adhesive that resists the oils in vinyl that cause other adhesives to fail.

Each patch kit contains: (1) 3" x 12" patch that cuts with scissors to any size, (1) 7/8" x 7/8" patch, (1) 1 3/8" x 1 3/8" patch, (1) 12" reinforcement filament for repairing tears at edges, (2) alcohol preparation pads, (1) illustrated instructions and a product repair list. Retail kits include display.

ITEM #	DESCRIPTION	STANDARD PACKAGE
212041	Fabric Type A	1
212043	Fabric Type A	20
212040	Variety	1
212044	Vinyl Type B	20
212042	Vinyl Type B	1

Tear-Aid® is a registered trademark of TEARepair Inc. Sunbrella® is a registered trademark of Glen Raven, Inc.



212020



Tear-Aid® Roll Patches

Repairing torn canvas, nylon, rubber, plastic or vinyl has never been easier with Tear-Aid Roll Patches. Clear, elastic Tear-Aid Roll Patches contain a high performance adhesive preapplied to a rugged backing that allows a tear to recover under pressure. No messy liquid adhesives are needed. All you do is peel and stick.

Tear-Aid Roll Patches are available in two styles – Type A and Type B. Type A is designed for the repair of canvas, nylon, rubber and plastic. Type A should not be used on vinyl or vinyl coated products, as the inherent oils in vinyl will cause the adhesive in Type A to fail prematurely. Type B has been designed specifically for the repair of vinyl or vinyl coated items only, as it contains special adhesives to resist the oils in vinyl that would otherwise cause premature failure.

Tear-Aid Roll Patches also have excellent durability against puncture, moisture, saltwater, sunlight and temperature. Convenient 30 foot rolls, in versatile widths of 3 inch or 6 inch, allow patches to be custom-cut and overlapped for unlimited size and unlimited repair applications, from boat tops, covers and seats, to canvas and vinyl tents and tarpaulins, to awnings, banners and umbrellas.

ITEM #	DESCRIPTION	SIZE	STANDARD PACKAGE
212020	Fabric Type A	3 in. x 30 ft.	1
212022	Fabric Type A	6 in. x 30 ft.	1
212021	Vinyl Type B	3 in. x 30 ft.	1
212023	Vinyl Type B	6 in. x 30 ft.	1

Tear-Aid® is a registered trademark of TEARepair Inc.



214309

210® Plastic Cleaner And Polish

Removes marks such as crayons, magic markers and paint over-spray. Cleaning is quick and easy, as 210 doesn't leave streaks or swirl marks. It provides an anti-static/anti-fog coating and seals pores in plastic for a protective coating that makes future cleaning easier. Gives plastic a clear, lustrous look and has a pleasant aroma. Use on a wide variety of surfaces including plastic, acrylic, formica, fiberglass, polycarbonate, PVC, polyester, vinyl and many others.

ITEM #	DESCRIPTION	PUT UP	STANDARD PACKAGE
214309	Cleaner/Polish	14 oz. spray can	1

210® is a registered trademark of Camco Manufacturing.

210® Plus Plastic Scratch Remover

An extremely mild abrasive compound in an anti-static/ anti-fog formula. Ideal for the removal of surface scratches and blemishes and for heavy-duty cleaning of all plastic materials. 210 Plus is water soluble and easy to use with superb results.



214310

ITEM #	PUT UP	STANDARD PACKAGE
214310	15 oz. bottle	1

210® is a registered trademark of Camco Manufacturing.

303® Aerospace Protectant™

303 is the leader in UV screening technology. Regular use gives 100% prevention of UV-caused slow-fade. No other "protectant" beautifies as intensely, protects as powerfully or lasts as long. Treated surfaces repel dirt, soiling, staining, water spots, salt water and mildew. Its water repellency and unparalleled protective characteristics have manufacturers worldwide recommending it. Keeps UV-sensitive materials "like new" year after year. Use on rubber, vinyl, inflatable boats, plastics/acrylics/polycarbonates, finished leather, gelcoat fiberglass, carbon-fiber/resin composites, pool and patio plastic furniture, pool inflatables, Sailcloth: Dacron® and monofilm. Applying is a breeze... spray on/wipe dry!



214091

ITEM #	STYLE #	PUT UP	STANDARD PACKAGE
214083	30307-12	10 oz. trigger sprayer	12
214091	30340	16 oz. trigger sprayer	6
214092	30313	1 qt. refill	6
214093	30320	1 gal. refill	4

303® is a registered trademark of Gold Eagle, Inc. 303 Aerospace Protectant™ is a trademark of Gold Eagle, Inc. Dacron® is a registered trademark of Invista.



214084

303® Spot Cleaner

For carpeting, upholstery, outdoor fabric or any water-safe material. Safely removes even the most difficult stains; soils, oil, grease, ink, berry juice, wine and blood. Spray on, wipe or rinse clean. Leaves no residue. Excellent for machine extractors. No foam, no fumes, no odor.

ITEM #	STYLE #	PUT UP	STANDARD PACKAGE
214084	30209	32 oz. trigger sprayer	6

303® is a registered trademark of Gold Eagle, Inc.



214080

303® Multi-Surface Cleaner™

For marine canvas, fabric convertible tops, awnings, indoor and outdoor furniture, carpet and upholstery. Industrial strength concentrate. For spot cleaning, use full strength or diluted. Safely removes even the most difficult stains. Perfect to pre-clean canvas prior to re-treating with 303 High Tech Fabric Guard. Rinses residue free. No foam, no fumes, no odor.

303 High Tech Fabric Guard and 303 Fabric Cleaner are recommended by/for Sunbrella®/Glen Raven, Inc.

303 Products should not be used on Strataglass™ and Crystal Clear 20/20 Clear Vinyl.

ITEM #	STYLE #	PUT UP	STANDARD PACKAGE
214079	30208	1 gal.	8
214080	30207	32 oz. trigger sprayer	6
214085	30501	2 oz. pump sprayer	25

303® is a registered trademark of Gold Eagle, Inc. 303 Multi-Surface Cleaner™ is a trademark of Gold Eagle, Inc. Sunbrella® is a registered trademark of Glen Raven, Inc. Strataglass™ is a trademark of Strataglass, LLC.



214098

303® Fabric Guard™

303 Fabric Guard: The only re-treatment product endorsed by Glen Raven, Inc. for its Sunbrella® awning, marine and casual furniture fabric.

Powerful enough to protect fabrics in the harshest environment... the outdoors. Yet 303 Fabric Guard is safe for the finest fabrics, wool, silk and fine leathers – including suede. On outdoor fabrics, 303 HTFG restores lost water repellency and stain repellency to factory new levels. 303 HTFG stops leaks, protects against soiling and both water and oil based stains, impedes mildew formation and helps protect against the sun's harmful UV rays.

Proper maintenance with 303 Products will add to the life of your fabrics, save you money, and... It's Easy – Spray on, let dry!

ITEM #	STYLE #	PUT UP	STANDARD PACKAGE
214086	30601	2 oz. pump sprayer	16
214096	30607	1 gal. refill	4
214098	30605	16 oz. trigger sprayer	6
214345	30606	32 oz. trigger sprayer	6

303® is a registered trademark of Gold Eagle, Inc. 303 Fabric Guard™ is a trademark of Gold Eagle, Inc. Sunbrella® is a registered trademark of Glen Raven, Inc.

Polyfab™ Pro Shade Sail Cleaner

A concentrated, high-strength cleaner, designed to remove difficult soils from tension shade structures such as hip and ridge and tension membrane shade sails made of Polyfab HDPE knitted sailcloth (or equivalent quality fabric), PVC coated or laminated fabrics. The cleaner is environmentally friendly, non-toxic, biodegradable, and contains no butyl. Protect from freezing. Best if used above 45°.

Depending on the degree and type of soiling, method of application, concentration and environmental conditions, you may expect to clean approximately 600 square feet per gallon.

ITEM #	PUT UP	STANDARD PACKAGE
214010	32 oz. bottle	12
214011	1 gal.	4

Polyfab™ is a trademark of Polyfab USA.

Aqua-Tite® II Green SPG

Aqua-Tite Green post treatment water repellent, has been reformulated and now uses silicone as the active ingredient, while still adhering to all known VOC (volatile organic compound) standards.

By using silicone, which is one of the most effective water repellent substances available, Aqua-Tite Green SPG now provides a finished product that is easy to apply, environmentally friendly and has the same performance characteristics of the original Aqua-Tite product.

Not recommended for use on Sunbrella® fabrics.

ITEM #	PUT UP	STANDARD PACKAGE
214308	1 qt.	12
214312	1 gal.	6

Aqua-Tite® is a registered trademark of Marlen Textiles. Sunbrella® is a registered trademark of Glen Raven, Inc.

APCO VinylClean Plus™

VinylClean Plus is a concentrated, heavy-duty vinyl cleaner and de-oxidizer. Effective for the removal of most soils and chalking due to plasticizer migration.

VinylClean Plus may be safely used on virtually any vinyl surface. Strong enough to remove stains, yet safe to use on a frequent maintenance schedule. Depending on the degree and type of soiling, method of application, concentration and environmental conditions, expect to clean approximately 600 square feet per gallon.

ITEM #	DESCRIPTION	PUT UP	STANDARD PACKAGE
214214	Concentrate	1 gal.	4
214217	Concentrate	32 oz.	12
214215	Concentrate	5 gal.	1
214216	Ready-To-Use	32 oz. sprayer	12

VinylClean Plus™ is a trademark of APCO Products.

APCO Vinyl Protector

Vinyl Protector replenishes and maintains vitality to vinyl fabrics that have been subjected to environmental exposure and plasticizer migration. It's formulated to repel dirt, inhibit stains, and minimize UV damage.

Vinyl Protector should be applied following every cleaning to help maintain the appearance of vinyl by offering soil, UV and mildew protection. Depending upon the type and condition of the fabric, method of application and environmental conditions, expect approximately 600 square feet per gallon of surface protection.

ITEM #	PUT UP	STANDARD PACKAGE
214218	1 gal.	4
214220	32 oz. sprayer	12
214219	5 gal.	1

APCO FabClean™ Green

FabClean Green is a concentrated, high-strength green cleaning solution designed for the maintenance of open weave fabrics such as awnings, boat tops, covers and enclosures, and outdoor furniture cushions. FabClean Green can be used for general maintenance and heavily soiled conditions. Depending on the degree and type of soiling, method of application, concentration and environmental conditions, expect to clean approximately 500 square feet per gallon.

ITEM #	DESCRIPTION	PUT UP	STANDARD PACKAGE
214221	Concentrate	1 gal.	4
214222	Concentrate	32 oz.	12
214223	Concentrate	5 gal.	1
214224	Ready-To-Use	32 oz. sprayer	12

FabClean™ is a trademark of APCO Products.

APCO TentClean™ Green

TentClean Green is a concentrated, high-strength vinyl cleaner, designed to remove difficult soils from all vinyl fabrics with minimal effort. TentClean Green may be used on all vinyl surfaces and can be used for general maintenance and heavily soiled conditions. Depending on the degree and type of soiling, method of application, concentration and environmental conditions, expect to clean approximately 600 square feet per gallon.

ITEM #	DESCRIPTION	PUT UP	STANDARD PACKAGE
214227	Concentrate	1 gal.	4
214228	Concentrate	32 oz.	12
214225	Concentrate	5 gal.	1
214226	Ready-To-Use	32 oz. sprayer	12

TentClean™ is a trademark of APCO Products.

APCO Apeal™

Apeal is a premium open weave fabric protector and water repellent that provides maximum water repellency and stain protection, plus inhibits UV damage and mildew growth. For best results, Apeal should be applied when fabric is clean and dry. Depending on the degree and type of soiling, method of application and environmental conditions, expect approximately 600 square feet per gallon of surface protection.

ITEM #	PUT UP	STANDARD PACKAGE
214229	1 gal.	4
214231	32 oz. sprayer	12
214230	5 gal.	1

Apeal™ is a trademark of APCO Products.



213980

IMAR™ #301 Strataglass™ Protective Cleaner

Uniquely formulated to clean, shine and protect Strataglass and Crystal Clear 20/20 clear vinyl and its scratch-resistant protective coating. Special UV inhibitors significantly extend the useful life of Strataglass by minimizing the deteriorating effects of sunlight. This helps defeat age-induced brittleness and promotes continued flexibility. Safe to use daily and is recommended to be used often to properly maintain the clarity of Strataglass. Helps rejuvenate the protective properties of IMAR Strataglass Protective Polish #302, which should be used on a less frequent but regular schedule.

Strataglass, Inc., manufacturers of Strataglass and Crystal Clear 20/20, endorse IMAR.

Strataglass Protective Cleaner and IMAR Strataglass Protective Polish for maximum benefit and recommend its regular use on Strataglass and Crystal Clear 20/20. Use of any cleaner or polish product other than IMAR Strataglass Protective Cleaner and Polish voids the factory warranty.

ITEM #	PUT UP	STANDARD PACKAGE
213980	4 oz. spray bottle	24
213981	16 oz. spray bottle	12
213983	1 gal. bottle	4

IMAR™ is trademark of IMAR Products, LLC. Strataglass™ is a trademark of Strataglass, Inc.



213985

IMAR™ #302 Strataglass™ Protective Polish

A polymer-based product formulated to safely clean, polish and protect Strataglass and Crystal Clear 20/20 clear vinyl and its scratch-resistant protective coating. Designed with a unique molecular bonding that creates a nearly invincible protective barrier against the damaging effects of marine environment pollutants. Recommended for use every 2 to 3 months and every 4 to 6 weeks in areas of high fallout. Frequent use of IMAR Strataglass Protective Cleaner #301 between polishing will increase protection by rejuvenating the protective qualities of IMAR Strataglass Protective Polish.

ITEM #	PUT UP	STANDARD PACKAGE
213984	4 oz. spray bottle	24
213985	16 oz. bottle	12
213987	1 gal. bottle	4

IMAR™ is trademark of IMAR Products, LLC. Strataglass™ is a trademark of Strataglass, Inc.



213988

IMAR™ #401 Yacht Soap Concentrate

Formulated with a unique blend of surfactants to create its highly polished appearance. Its non-streaking, non-spotting formulation rinses clear and decreases drying time. IMAR Yacht Soap Concentrate avoids the use of harsh alkalis, acids and abrasives, so it protects durable polishes while thoroughly cleaning. This is the perfect complement to Strataglass™ Protective Cleaner and Strataglass Protective Polish.

ITEM #	PUT UP	STANDARD PACKAGE
213988	4 oz. bottle	24
213989	16 oz. bottle	12

IMAR™ is trademark of IMAR Products, LLC. Strataglass™ is a trademark of Strataglass, Inc.



213993

IMAR™ #402 Yacht Polish

Its unique blend of polymers cleans, polishes, shines and protects fiberglass, gel coat, metal paint and other marine environment hard surfaces. Safely removes light oxidation, marks and stains while creating a protective barrier to UV damage, soil, back scuffs, insect droppings, mildew and other stains.

ITEM #	PUT UP	STANDARD PACKAGE
213993	16 oz. bottle	12

IMAR™ is trademark of IMAR Products, LLC.



213971

IMAR™ #601 Stamoid® Marine Vinyl Protective Cream

This polymer-based cream is specially formulated to protect Stamoid and other vinyl fabrics in marine environments. It maintains the like-new suppleness and luster of fabrics. With UV protection, static resistance and life-extending plasticizers, the proprietary formulation causes molecular bonding which creates a virtually impregnable protective barrier. Recommended usage is every 2-3 months.

ITEM #	PUT UP	STANDARD PACKAGE
213971	16 oz. bottle	12

IMAR™ is a trademark of IMAR Products, LLC. Stamoid® is a registered trademark of The Serge Ferrari Group.



213972

IMAR™ #602 Stamoid® Marine Vinyl Protective Spray

Formulated to clean, shine and protect Stamoid marine vinyl and similar vinyl products, this protective spray has special UV inhibitors. It will significantly extend the useful life of vinyl fabrics by minimizing the deteriorating effects of direct sunlight. UV protection, coupled with the rejuvenation effects of plasticizers, help eliminate age-induced brittleness and assure a longer product life. This IMAR protective spray enhances the protective qualities of IMAR #601 Stamoid Marine Protective Cream.

ITEM #	PUT UP	STANDARD PACKAGE
213972	16 oz. spray bottle	12

IMAR™ is a trademark of IMAR Products, LLC. Stamoid® is a registered trademark of The Serge Ferrari Group.



213973

IMAR™ #603 Stamoid® Marine Vinyl Cleaner

Specially formulated to gently but thoroughly clean Stamoid and other marine vinyls. It will not harm clear vinyls such as Strataglass™, when used according to the instructions. Frequent use is recommended, particularly in areas of high environmental pollutants. Application of IMAR Stamoid Marine Vinyl Protective Cream and IMAR Stamoid Marine Vinyl Protective Spray between cleanings will assure the continued like-new appearance of vinyl products.

ITEM #	PUT UP	STANDARD PACKAGE
213973	16 oz. bottle	12

IMAR™ is a trademark of IMAR Products, LLC. Stamoid® is a registered trademark of The Serge Ferrari Group. Strataglass™ is a trademark of Strataglass, LLC.

IMAR® #604 Stamoid® Marine Vinyl Care Bucket

Stamoid® Marine Vinyl Care Bucket contains a 2-1/2 gallon bucket with a sponge pad and one (1) each of IMAR Stamoid Marine Vinyl Protective Cream, IMAR Stamoid Marine Vinyl Protective Spray and IMAR Stamoid Marine Vinyl Cleaner. All in 16 ounce sizes.

ITEM #	STYLE #	STANDARD PACKAGE
213974	604	1

IMAR™ is a trademark of IMAR Products, LLC. Stamoid® is a registered trademark of The Serge Ferrari Group.

IMAR® #42 Detail Kit

Detail Kit #42 contains one each of IMAR Strataglass™ Protective Cleaner, IMAR Strataglass Protective Polish and IMAR Yacht Soap Concentrate. All in 4 ounce sizes.

ITEM #	STYLE #	STANDARD PACKAGE
213978	42	12

IMAR™ is a trademark of IMAR Products, LLC. Strataglass™ is a trademark of Strataglass, LLC.



214191

IOSSO® Mold And Mildew Stain Remover

Removes mold, mildew, algae stain, tough dirt, oils, leaf stains, tree sap, bird droppings, food stains, and blood stains. Recommended for use on awnings, canopies, tents, patio furniture, cushions, umbrellas, spa covers, tarps, boat covers, camping gear, vinyl, plastic and fiberglass. It is gentle to skin and has no harmful vapors. Just add water to the biodegradable, non-chlorine powder and work the solution into the soiled area. One gallon covers up to 150 square feet. The 12 ounce jar makes three gallons of solution. The 65 ounce pail mixes up 16 gallons of solution.

ITEM #	STYLE #	PUT UP	STANDARD PACKAGE
214190	10900	12 oz. jar	6
214191	10905	65 oz. pail	1

IOSSO® is a registered trademark of IOSSO Products, Inc.



214378

IOSSO® Water Repellent

Effective on all fabrics. Protects from water, soils, oils, bird droppings, and environmental pollutants. It resists mildew, stains, and increases weatherability. Will not change the color, feel or breathability of the fabric. Recommended for use on awnings, canopies, tents, patio furniture cushions, umbrellas, spa covers, tarps, boat covers, bimini tops, hunting fabrics, camping gear, leather, synthetics, and vinyl. Formula is non-solvent and non-silicon. For Ready-To-Use, the 32 ounce bottle covers approximately 37 square feet and one gallon covers up to 150 square feet. For Concentrate, 32 ounces makes 2 gallons, 1 gallon makes 5 gallons and 5 gallons makes 25 gallons.

ITEM #	STYLE #	DESCRIPTION	PUT UP	STANDARD PACKAGE
214378	10919	Concentrate	32 oz.	12
214358	11905	Concentrate	5 gal.	1
214195	10918	Concentrate	1 gal.	1
214354	11900	Ready-Use	5 gal.	1
214171	10916	Ready-Use	32 oz. spray bottle	6
214194	10917	Ready-Use	1 gal.	1

IOSSO® is a registered trademark of IOSSO Products, Inc.



214373

IOSSO® Fabric Cleaner & Protectant Kit

Fabric Cleaner/Protectant Kit for Awnings, Boat Covers and RV/Campers.

Perfect for your showroom or shop counter display, this kit contains one jar of Mold and Mildew Stain Remover and one bottle of Water Repellent Concentrate. That's enough to clean and protect up to 450 square feet of fabric. The products are packaged together in an attractive point-of-purchase display box.

ITEM #	STYLE #	STANDARD PACKAGE
214373	10901	1

IOSSO® is a registered trademark of IOSSO Products, Inc.

IOSSO® Metal Polish

Removes oxidation, tarnish, surface rust and water spots. Polishes to a high shine and protects for months. Recommended for all types of metals including stainless steel, aluminum, copper, brass, silver and gold. Cleans without scratching.

ITEM #	STYLE #	PUT UP	STANDARD PACKAGE
214186	10333	3 oz. tube	12

IOSSO® is a registered trademark of IOSSO Products.



214314

Klear-To-Sea™

A cleaner and preservative, Klear-To-Sea is formulated for plastics, clear vinyl windshields, mirrors, glass and much more. Cleaning is quick and easy with no streaks or smudging and resists fingerprints. Klear-to-Sea leaves an anti-static, anti-fog invisible film coating, with UV protection, that also protects against salt spray.

ITEM #	PUT UP	STANDARD PACKAGE
214313	19 oz. can	12
214314	16 oz. pump	12

Klear-To-Sea™ is a registered trademark of Doctor Klear, Inc.



214460

Super-Tuff™

Super-Tuff™ can be used as an all purpose cleaner and degreaser, mildew remover (non-toxic), and spot cleaner. It is safe for most washable surfaces and fabrics. Available in quart size.

ITEM #	PUT UP	STANDARD PACKAGE
214460	1 qt.	1

Super-Tuff™ is a trademark of Doctor Klear, Inc.



210801

Canvak

Canvak is a refinishing compound that restores water repellency to cotton fabrics. It is normally sold as a semi-clear solution which may be applied to any color fabric. However, it contains wax and may leave a water repellent film on the fabric. It is recommended that Canvak be applied to a small inconspicuous area first to be sure the product will create the desired results. Canvak is not recommended for use on synthetic fabrics.

ITEM #	COLOR	PUT UP	STANDARD PACKAGE
210801	Clear	1 gal.	6

Buckeye Fabric Finishing Co. warning for Canvak: **FLAMMABLE** Keep away from heat and open flame. Do not use near welding, cutting torch, or metal scraping tools. Close container after each use. Flash point 104°. Use in a well-ventilated area. Avoid repeated or prolonged contact with skin and breathing of vapors or mist spray. Neoprene gloves recommended for long exposure. Excessive inhalation could cause dizziness or nausea. Can cause severe eye irritation. Flush eyes with large amounts of water. Wear splash goggles for eye protection. Do not ingest. Swallowing could cause vomiting and diarrhea, and could possibly be fatal.



214199

IOSSO® E-Z Snap Lubricant

For snaps, zippers, hinges and hardware. Lubricates, waterproofs and reduces friction. It keeps snaps from corroding and locking up. It keeps zippers free flowing. E-Z Snap will not rinse away or dissipate in hot weather. The formula is non-hazardous and does not contain solvents, silicone or Teflon®. Great on boat covers, tents and campers.

ITEM #	STYLE #	PUT UP	STANDARD PACKAGE
214199	10909	1.5 oz.	24

IOSSO® is a registered trademark of IOSSO Products, Inc. Teflon® is a registered trademark of E. I. DuPont Nemours and Company.



230140

Mr. Clearco Food Grade Silicone Spray

Mr. Clearco Food Grade Silicone Spray is formulated for a wide array of applications to prevent sticking and to provide slide. The active ingredient is polydimethylsiloxane (CAS # 63148-62-9) that is clear, colorless, odorless and inert. The silicone film that is imparted on the surface provides excellent lubricity, high dielectric strength, and protection against corrosion. It is safe to use on the majority of plastic and rubber surfaces. For lubrication applications involving plastic, rubbers and foams, it is an excellent choice.

Mr. Clearco Silicone Spray meets California VOC and OTC Compliancy for Industrial Use. It contains no hexane, acetone, CFC's or ozone depleting chemicals. The can's spray heads and valves provide maximum efficiency.

Sewing and Cutting Room Applications

Reduces friction and wear when applied to fabric cutting tables, bobbins, sewing needles, presser feet, and sewing thread.

Upholstery/Furniture Applications

Prevents polyurethane foam from sticking to tabletops, allows cellophane, film, saran and vinyl polyethylene to move freely over sprayed surfaces. Provides slide for plastic, prevents glue and adhesive from adhering, stops squeaking in doors, windows and assemblies, Prevents jamming of equipment caused by glues, adhesives, waxes, etc.

ITEM #	PUT UP	STANDARD PACKAGE
230140	13 oz. aerosol can	12



214324

Ultra Tef-Gel®

The function of Tef-Gel in eliminating dissimilar metal corrosion is the elimination of electrolytes from entering the interface of the metallic surfaces. Tef-Gel paste contains 40% PTFE powder and 0% volatile solvents, no silicones or petroleum solvents to evaporate, which would leave voids for electrolytes to be drawn into creating a galvanic cell. When both surfaces are coated and mated with Tef-Gel there are no voids for electrolytes (saltwater) to be drawn in by capillary action over extended periods of time.

Thread galling is a common, yet seldom understood problem with threaded fasteners. Galling, often referred to as a cold-welding process, can occur when the surfaces of male and female threads are placed under heavy pressure.

Stainless steel fasteners are particularly susceptible to thread galling, although it also occurs in other alloys that self-generate an oxide surface film, such as aluminum and titanium. During the tightening of the fastener, pressure builds between the contacting thread surfaces and breaks down the protective oxide coatings. With the absence of the oxide coating, the metal high points of the threads are exposed to one another, which increases friction. The combination of these two events can generate enough heat to fuse and seize the nut and bolt together.

Galling can be minimized with the following measures:

Thread lubrication is one of the most effective measures to decrease the potential for galling. The lubricant reduces friction, which is a key element in thread galling. There are some outstanding PTFE based coatings that can be applied to stainless steel fasteners. They are able to drastically reduce the frictional coefficient.

ITEM NUMBER	STYLE NUMBER	PUT UP	STANDARD PACKAGE
214324	TG-04	4 oz. tub	1

Tef-Gel® is a registered trademark of Ultra Safety Systems, Inc.

Polyfab™ Pro Shade Sail Hardware

This premium line of marine grade AISI 316/304 stainless steel and other steel hardware is recommended for use in tension shade structures such as hip and ridge and tension membrane shade sails in conjunction with HDPE knitted shade cloth or equivalent quality fabric. The finished structure needs to be properly engineered by a professional engineer and installed by a qualified contractor in accordance with local building codes.

It is the responsibility of the fabricator within these parameters to determine the proper hardware for a particular installation.

Please refer to www.trivantage.com for proper care and cleaning of all Polyfab Pro hardware.

WARRANTY	5-Year
-----------------	--------



ITEM #	STYLE #	DESCRIPTION	FOR	MATERIAL	PUT UP	SIZE	STANDARD PACKAGE	THREADED FOR SIZE
240075	HS-345CR	Croc Heavy Duty Hand Swage Tool for 3, 3.2, 4, 5mm Wire	3, 3.2, 4 and 5 mm wire		1/each		1	
240076	HS-6810CR	Croc Heavy Duty Hand Swage Tool for 6, 8, 10mm Wire	6, 8, and 10 mm wire		1/each		1	
240116	ZN-ZB14	Deck Post Bracket Set		Zinc Plated Steel	1/each		1	
240014	SS-SD-10	Polyfab Dee Shackle		AISI 316 Stainless Steel	1/each	10 mm	1	M10
240013	SS-SD-08	Polyfab Dee Shackle		AISI 316 Stainless Steel	1/each	8 mm	1	M8
240016	SS-SLD-10	Polyfab Long Dee Shackle		AISI 316 Stainless Steel	1/each	10 mm	150	M10
240015	SS-SLD-08	Polyfab Long Dee Shackle		AISI 316 Stainless Steel	1/each	8 mm	150	M8
240021	SS-SLT-10	Polyfab Long Twisted Shackle		AISI 316 Stainless Steel	1/each	10 mm	150	M10
240020	SS-SLT-08	Polyfab Long Twisted Shackle		AISI 316 Stainless Steel	1/each	8 mm	280	M8
240008	SS-TBST-12	Polyfab Pro Closed-Body Turnbuckle with Swivel Toggle Ends		AISI 316 Stainless Steel	1/each	12mm (1/2")	50	M12
240009	SS-TBST-16	Polyfab Pro Closed-Body Turnbuckle with Swivel Toggle Ends		AISI 316 Stainless Steel	1/each	16mm (5/8")	50	M12
240105	AL-DISK-06	Polyfab Pro Corner Disk Assembly		Stamped Aluminum	1/each		1	
240045	SS-DRG-06	Polyfab Pro Dee Ring		AISI 316 Stainless Steel	1/each	6 x 50 mm	500	
240046	SS-DRG-08	Polyfab Pro Dee Ring		AISI 316 Stainless Steel	1/each	8 x 50 mm	300	
240057	SS-DRTH-1065	Polyfab Pro Dee Ring Thimble		AISI 316 Stainless Steel	1/each	10 x 65 mm	70	
240055	SS-DRTH-650	Polyfab Pro Dee Ring Thimble		AISI 316 Stainless Steel	1/each	6 x 50 mm	300	
240056	SS-DRTH-850	Polyfab Pro Dee Ring Thimble		AISI 316 Stainless Steel	1/each	8 x 50 mm	230	
240090	ZN-WPD-100	Polyfab Pro Diagonal Eye Wall Plate		Zinc Plated Steel	1/each	100 mm	20	
240091	ZN-WPD-150	Polyfab Pro Diagonal Eye Wall Plate		Zinc Plated Steel	1/each	150 mm	1	
240095	SS-PED-90	Polyfab Pro Diamond Pad Eye		AISI 316 Stainless Steel	1/each	80 mm	50	
240096	SS-PED-100	Polyfab Pro Diamond Pad Eye		AISI 316 Stainless Steel	1/each	100 mm	30	
240094	SS-WPD-180	Polyfab Pro Diamond Wall Plate with 100mm Shackle Eye		AISI 316 Stainless Steel	1/each	180 x 110 mm	1	
240050	SS-DRHD-05	Polyfab Pro Easy-Hold Dee Ring		AISI 316 Stainless Steel	1/each	5 x 50 mm	1	
	SS-DRHD-10	Polyfab Pro Easy-Hold Dee Ring		AISI 316 Stainless Steel		10 x 55 mm	1	
240051	SS-DRHD-08	Polyfab Pro Easy-Hold Dee Ring		AISI 316 Stainless Steel	1/each	8 x 50 mm	300	
240083	ZN-CBEX-250	Polyfab Pro External Corner Bracket		Zinc Plated Steel	1/each	250 mm	10	
240082	ZN-CBEX-100120	Polyfab Pro External Corner Bracket		Zinc Plated Steel	1/each	100 x 120 mm	10	
240113	ZN-CBEX-150	Polyfab Pro External Corner Bracket		Zinc Plated Steel	1/each	150 mm	1	
240080	ZN-CBEX-100	Polyfab Pro External Corner Bracket		Zinc Plated Steel	1/each	100 mm	10	



240048

240031



240030

240044



240104

240101



240102

240103



240100

240042



240115

240084



240081

240114



240033

240073

ITEM #	STYLE #	DESCRIPTION	FOR	MATERIAL	PUT UP	SIZE	STANDARD PACKAGE	THREADED FOR SIZE
240048	SS-EYBC-08	Polyfab Pro Eye Bolt with Collar		AISI 316 Stainless Steel	1/each	8 mm	1	M8
240049	SS-EYBC-10	Polyfab Pro Eye Bolt with Collar		AISI 316 Stainless Steel	1/each	10 mm	1	M10
240053	SS-EYBC-12	Polyfab Pro Eye Bolt with Collar		AISI 316 Stainless Steel	1/each	12 mm	1	M12
240031	SS-EYB-08120	Polyfab Pro Eye Bolt, Nut, 2 Washers		AISI 316 Stainless Steel	1/each	8 x 120 mm	80	M8
240032	SS-EYB-10120	Polyfab Pro Eye Bolt, Nut, 2 Washers		AISI 316 Stainless Steel	1/each	10 x 120 mm	50	M10
240030	SS-EYN-12	Polyfab Pro Eye Nut		AISI 316 Stainless Steel	1/each	12 mm	50	M12
240044	SS-EYN-08	Polyfab Pro Eye Nut		AISI 316 Stainless Steel	1/each	8 mm	1	M8
240047	SS-EYN-10	Polyfab Pro Eye Nut		AISI 316 Stainless Steel	1/each	10 mm	1	M10
240037	SS-EYNB-10600	Polyfab Pro Eye Nut Bolt, Nut, Washer		AISI 316 Stainless Steel	1/each	10 x 160 mm	50	M10
240064	SS-EYNB-12150	Polyfab Pro Eye Nut Bolt, Nut, Washer		AISI 316 Stainless Steel	1/each	12 x 150mm	1	M12
240038	SS-EYNB-12200	Polyfab Pro Eye Nut Bolt, Nut, Washer		AISI 316 Stainless Steel	1/each	12 x 200 mm	40	M12
240054	SS-EYNB-12120	Polyfab Pro Eye Nut Bolt, Nut, Washer		AISI 316 Stainless Steel	1/each	12 x 120mm	1	M12
240036	SS-EYNB-10100	Polyfab Pro Eye Nut Bolt, Nut, Washer		AISI 316 Stainless Steel	1/each	10 x 100 mm	50	M10
240104	ZN-FB2W	Polyfab Pro Fascia Bracket Two Way		Zinc Plated Steel	1/each		10	
240101	ZN-FBLH	Polyfab Pro Fascia Bracket for 20 Degree Rafter Angle Left		Zinc Plated Steel	1/each		10	
240102	ZN-FBRH	Polyfab Pro Fascia Bracket for 20 Degree Rafter Angle Right		Zinc Plated Steel	1/each		10	
240103	ZN-FB90	Polyfab Pro Fascia Bracket for Flat Roof		Zinc Plated Steel	1/each		10	
240100	ZN-FBTH	Polyfab Pro Fascia Bracket with 12mm Threaded Rod		Zinc Plated Steel	1/each		10	
240042	SS-HN-08	Polyfab Pro Hex Nut		AISI 316 Stainless Steel	1/each	8 mm	1	M8
240069	SS-HN-10	Polyfab Pro Hex Nut		AISI 316 Stainless Steel	1/each	10 mm	1	M10
240115	ZN-CBIN-100120	Polyfab Pro Internal Corner Bracket		Zinc Plated Steel	1/each	100 x 120 mm	1	
240084	ZN-CBIN-250	Polyfab Pro Internal Corner Bracket		Zinc Plated Steel	1/each	250 mm	10	
240081	ZN-CBIN-100	Polyfab Pro Internal Corner Bracket		Zinc Plated Steel	1/each	100 mm	10	
240114	ZN-CBIN-150	Polyfab Pro Internal Corner Bracket		Zinc Plated Steel	1/each	150 mm	1	
240033	SS-LNN-08	Polyfab Pro Nylon Lock Nut		AISI 316 Stainless Steel	1/each	8 mm	80	M8
240034	SS-LNN-10	Polyfab Pro Nylon Lock Nut		AISI 316 Stainless Steel	1/each	10 mm	50	M10
240035	SS-LNN-12	Polyfab Pro Nylon Lock Nut		AISI 316 Stainless Steel	1/each	12 mm	40	M12
240073	SS-WRC-10	Polyfab Pro Rope Clamp		AISI 316 Stainless Steel	1/each	10 mm	1	
240066	SS-WRC-06	Polyfab Pro Rope Clamp		AISI 316 Stainless Steel	1/each	6 mm	600	
240074	SS-WRC-03	Polyfab Pro Rope Clamp		AISI 316 Stainless Steel	1/each	3.2 mm	1	



ITEM #	STYLE #	DESCRIPTION	FOR	MATERIAL	PUT UP	SIZE	STANDARD PACKAGE	THREADED FOR SIZE
240067	SS-WRC-08	Polyfab Pro Rope Clamp		AISI 316 Stainless Steel	1/each	8 mm	300	
240111	SS-WRC-05	Polyfab Pro Rope Clamp		AISI 316 Stainless Steel	1/each	5 mm	1	
240065	SS-WRC-04	Polyfab Pro Rope Clamp		AISI 316 Stainless Steel	1/each	4 mm	1200	
240058	SS-RTH-1150	Polyfab Pro Round Thimble		AISI 316 Stainless Steel	1/each	11 x 50 mm	1	
240097	SS-SC-15	Polyfab Pro Safety Cable		AISI 316 Stainless Steel	1/each		1	
240010	SS-SBF-08	Polyfab Pro Shackle Bow		AISI 316 Stainless Steel	1/each	8 mm	450	M8
240012	SS-SBF-12	Polyfab Pro Shackle Bow		AISI 316 Stainless Steel	1/each	12 mm	120	M12
240011	SS-SBF-10	Polyfab Pro Shackle Bow		AISI 316 Stainless Steel	1/each	10 mm	200	M10
240107	SS-HKS-10	Polyfab Pro Spring Hook		AISI 316 Stainless Steel	1/each	10 mm	1	
240106	SS-HKS-08	Polyfab Pro Spring Hook		AISI 316 Stainless Steel	1/each	8 mm	1	
240077	NP-WRS-03	Polyfab Pro Swaging Sleeve		Nickel Plated Copper	1/each	3.2 mm	1	
240071	NP-WRS-06	Polyfab Pro Swaging Sleeve		Nickel Plated Copper	1/each	6 mm	180	
240072	NP-WRS-08	Polyfab Pro Swaging Sleeve		Nickel Plated Copper	1/each	8 mm	160	
240112	NP-WRS-05	Polyfab Pro Swaging Sleeve for 5mm Wire		Nickel Plated Copper	1/each	5 mm	1	
240063	SS-WRT-10	Polyfab Pro Thimble		AISI 316 Stainless Steel	1/each	10 mm	1	
240061	SS-WRT-06	Polyfab Pro Thimble		AISI 316 Stainless Steel	1/each	6 mm	1000	
240110	SS-WRT-05	Polyfab Pro Thimble		AISI 316 Stainless Steel	1/each	5 mm	1	
240059	SS-WRT-03	Polyfab Pro Thimble		AISI 316 Stainless Steel	1/each	3.2 mm	1	
240062	SS-WRT-08	Polyfab Pro Thimble		AISI 316 Stainless Steel	1/each	8 mm	500	
240040	SS-TRI-06	Polyfab Pro Triangle		AISI 316 Stainless Steel	1/each	6 x 50 mm	500	M6
240041	SS-TRI-08	Polyfab Pro Triangle		AISI 316 Stainless Steel	1/each	8 x 50 mm	350	M8
240108	SS-QLT-06	Polyfab Pro Triangle Quick Link		AISI 316 Stainless Steel	1/each	6 mm	1	
240109	SS-QLT-10	Polyfab Pro Triangle Quick Link		AISI 316 Stainless Steel	1/each	10 mm	1	
240007	SS-TBEE-12	Polyfab Pro Turnbuckle Eye/Eye		AISI 316 Stainless Steel	1/each	12 mm	50	M12
240006	SS-TBEE-10	Polyfab Pro Turnbuckle Eye/Eye		AISI 316 Stainless Steel	1/each	10 mm	100	M10
240005	SS-TBEE-08	Polyfab Pro Turnbuckle Eye/Eye		AISI 316 Stainless Steel	1/each	8 mm	150	M8
240000	SS-TBJJ-08	Polyfab Pro Turnbuckle Jaw/Jaw		AISI 316 Stainless Steel	1/each	8 mm	130	M8
240001	SS-TBJJ-10	Polyfab Pro Turnbuckle Jaw/Jaw		AISI 316 Stainless Steel	1/each	10 mm	80	M10
240002	SS-TBJJ-12	Polyfab Pro Turnbuckle Jaw/Jaw		AISI 316 Stainless Steel	1/each	12 mm	40	M12

Polyfab™ is a trademark of Polyfab USA

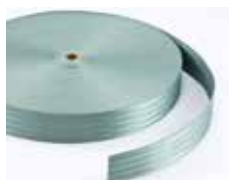

565111

Polyfab™ Shade Sail Edge Webbing

Polyfab Shade Sail Edge Webbing is used for shade structures and shade sails. This polyester webbing has a breaking strength of approximately 4,700 pound force. Available in 20 colors to match Polytex®, Comtex® and Architec 400® extra heavy duty knitted Shadecloth.

ITEM #	COLOR	COLOR #	PUT UP	WIDTH
565135	Antec Orange	22	109 yd.	2 in.
565129	Beige	72	109 yd.	2 in.
565137	Berry	36	109 yd.	2 in.
565121	Black	99	109 yd.	2 in.
565103	Blue	50	109 yd.	2 in.
565109	Bronze	81	109 yd.	2 in.
565131	Cafe Noir	35	109 yd.	2 in.
565113	Charcoal	92	109 yd.	2 in.
565141	Fluoro Green	67	109 yd.	2 in.
565118	Golden Yellow	11	109 yd.	2 in.
565101	Midnight Green	62	109 yd.	2 in.
565105	Navy Blue	51	109 yd.	2 in.
565115	Porcelain	71	109 yd.	2 in.
565139	Purple	58	109 yd.	2 in.
565127	Red	30	109 yd.	2 in.
565111	Sage	19	109 yd.	2 in.
565107	Sandstone	73	109 yd.	2 in.
565125	Silver Gray	91	109 yd.	2 in.
565119	Turquoise	10	109 yd.	2 in.
565133	White	01	109 yd.	2 in.

Polyfab™ is a trademark of Polyfab USA. Polytex®, Comtex® and Architec 400® are registered trademarks of Polyfab USA.



123004

Awning Hardware – Elbow

Plated, malleable iron. Threaded.

ITEM #	STYLE #	STANDARD PACKAGE	THREADED FOR PIPE SIZE
123002	2	25	3/8 in.
123003	3	25	1/2 in.
123004	4	25	3/4 in.
123005	5	25	1 in.
123008	8	25	1/2 in. x 3/4 in.

123002 - Also available in aluminum.

123003 - Also available in aluminum.

123004 - Also available in aluminum.



293412

Awning Hardware – Slip-Fit Elbow

Furnished with socket head set screws.

ITEM #	STYLE #	FOR	# OF SET SCREWS	STANDARD PACKAGE
293410	3-S	3/8 in. pipe	2	25
282004	4-S	1/2 in. pipe	2	25
293412	5-SQ	3/4 in. x 3/4 in. pipe	4	25
293413	6-SQ	1 in. x 1 in. pipe	4	25

293410 - Stainless steel set screws.
 282004 - Also available in malleable iron.
 293412 - Also available in malleable iron.
 293413 - Also available in malleable iron.



123389

Awning Hardware – Slip-Fit Square Elbow

Trivantage® Slip-Fit fittings, made of sturdy, plated, shockproof malleable iron, or plated steel as shown, offer a time and labor saving way to install patio awnings. No threading necessary, as all fittings simply slip on or over pipe frame, and are then secured by means of square head set screws. Slip-Fit fittings permit rapid adjustment when pipe is not cut to exact length.

Plated, malleable iron. Square design ensures a better fitting cover. Used to join front bars with end rafters. Ideal for use in joining right angles of any frame assembly. Furnished with set screws.



225135

ITEM #	STYLE #	FRONT BAR SIZE	RAFTER	STANDARD PACKAGE
123386	285	1/2 in. pipe	1/2 in. pipe	25
123387	287	3/4 in. pipe	3/4 in. pipe	25
123389	289	1 in. pipe	1 in. pipe	25
225135	15-7	1-1/4 in. pipe	1-1/4 in. pipe	25
244540	20-6	1 in. pipe	1 in. pipe	25

225135 - Hot dip galvanized – smooth design, with socket head screw.

Trivantage® is a registered trademark of Glen Raven, Inc.



244540



124702

Awning Hardware – Pin Or Nut End

Plated, malleable Iron. Threaded and fitted with a nut. Use with side nut hinge or front cotter hinge.

ITEM #	STYLE #	STANDARD PACKAGE	THREADED FOR SIZE
124702	2	25	1/2 in. pipe



281106

Awning Hardware – Eye End – Aluminum

Threaded.

ITEM #	STYLE #	FOR	STANDARD PACKAGE
281106	5A	3/4 in. pipe	25
293616	4A-4	1/2 in. pipe	25

293616 - Also available in malleable iron.



124002

Awning Hardware – Eye End – Malleable Iron

Use with side nut hinge or front cotter hinge. Plated, malleable iron. Threaded. Placed on the ends of arms and rafters for fastening onto hinges or jaws.

ITEM #	STYLE #	STANDARD PACKAGE	THREADED FOR SIZE	TYPE
124010	10	25	3/4 in. pipe	Large eye
124007	7	25	1/4 in. pipe or 1/2 in. iron	Large eye
124009	9	25	1/2 in. pipe	Large eye
124012	12	25	1 in. pipe	Small eye
124002	2	25	1/4 in. pipe or 1/2 in. iron	Small eye
124003	3	25	3/8 in. pipe or 5/8 in. iron	Small eye
124004	4	25	1/2 in. pipe	Small eye
124005	5	25	3/4 in. pipe	Small eye

124002 - Also available in aluminum.

124003 - Also available in aluminum.



282191

Awning Hardware – Slip-Fit Eye End – Aluminum

Furnished with socket head set screws.

ITEM #	STYLE #	FOR	STANDARD PACKAGE
282193	286A-304	1/2 in. pipe	25
282190	290A-305	3/4 in. pipe	25
282191	291A-315	1 in. pipe	25
282122	25	1/4 in. pipe	25

282122 - Also available in malleable iron.



124190

Awning Hardware – Slip-Fit Eye End

Trivantage® Slip-Fit fittings, made of sturdy, plated, shockproof malleable iron, or plated steel as shown, offer a time and labor saving way to install patio awnings. No threading necessary, as all fittings simply slip on or over pipe frame, and are then secured by means of square head set screws. Slip-Fit fittings permit rapid adjustment when pipe is not cut to exact length. A specially designed, plated, malleable iron eye end, properly proportioned for greatest rigidity.

Small eye permits snug fit between eye end and rod and rafter holder. Barrel depth of 2 inch assures greater holding power between eye end and pipe. Furnished with set screw.

ITEM #	STYLE #	MAXIMUM BOLT STANDARD	SIZE	STANDARD PACKAGE
124188	286	1/4 in.	1/2 in. pipe	25
124190	290	7/16 in.	3/4 in. pipe	25
124191	291	7/16 in.	1 in. pipe	25
124192	292	1/2 in.	1-1/4 in. pipe	25

124190 - Also available in aluminum.

124191 - Also available in aluminum.

Trivantage® is a registered trademark of Glen Raven, Inc.



281680

Awning Hardware – Front Bar Clamp – Aluminum

Front bar clamps provide fast and complete slip fit of pipe rafter to front bar. Simply tighten the set screws which are furnished and the operation is complete.

ITEM #	STYLE #	FOR	STANDARD PACKAGE
281680	380-A	3/4 in. x 3/4 in. pipe	25
281681	381-A	1 in. x 1 in. pipe	25



130581

Awning Hardware – Slip-Fit Adjustable Front Bar

Trivantage® Slip-Fit fittings, made of sturdy, plated, shockproof malleable iron, or plated steel as shown, offer a time and labor saving way to install patio awnings. No threading necessary, as all fittings simply slip on or over pipe frame, and are then secured by means of square head set screws. Slip-Fit fittings permit rapid adjustment when pipe is not cut to exact length.

A fitting made of plated steel clamps and zinc die-cast collar, with many applications where a sturdy reinforced assembly is required. Ideal for patio awning pipe frame assemblies, supporting pipe posts, pipe braces, and all types of special pipe frames.

The interlocking three-piece fitting provides a rigid, low cost assembly. Slip top section over pipe and adjust to desired position. Tighten set screw. Both hands are free to quickly bolt interlocking bottom section to top section for completed assembly.

ITEM #	STYLE #	FRONT BAR SIZE	REDUCING FOR PIPE SIZE	STANDARD PACKAGE
130580	280	3/4 in. pipe	3/4 in. pipe	25
130581	281	1 in. pipe	1 in. pipe	25
130582	282	1 in. pipe	3/4 in. pipe	25

Tolerance on sand casting: 1/32 inch to 4 inch dimension, 3/64 inch to 4 inch to 8 inch dimension. Tolerance on die casting: ± 0.005 inch.

Trivantage® is a registered trademark of Glen Raven, Inc.



112504

Awning Hardware – Head Rod Clamp – Zinc Die Cast

A fixture designed for attaching the head rod of an awning to various building surfaces, as well as providing hooks for hanging awning pulleys. Plated, zinc die-cast.



112509

ITEM #	STYLE #	FOR	SIZE HEAD ROD	STANDARD PACKAGE
112504	4	Wood	1/2 in. diameter iron	25
112509	6	Wood	1/2 in. diameter iron	25
112501	1	Wood	3/8 in. diameter iron	25
112505	5	Wood	3/8 in. diameter iron	25



112501

112509 - Stainless steel fasteners.



112630

Awning Hardware – Head Rod Clamp – Narrow Base Type – Zinc Die Cast

A fixture designed for attaching the head rod of an awning to various building surfaces, as well as providing hooks for hanging awning pulleys. Plated, zinc die-cast.

One countersunk hole for wood screw provides quick and solid installation. Furnished with machine bolt and wing nut.

ITEM #	STYLE #	SIZE HEAD ROD	STANDARD PACKAGE
112630	30Z	1/2 in. diameter iron	25

112630 - Also available in aluminum.



112510

Awning Hardware – Head Rod Clamp – Roller Curtain Type – Malleable Iron

A fixture designed for attaching the head rod of an awning to various building surfaces, as well as providing hooks for hanging awning pulleys.



112521

Plated, malleable iron. Fastens on inside of porch so that pulleys and pull ropes are on inside of curtain. Can be attached to either face board or ceiling.

ITEM #	STYLE #	FOR	SIZE HEAD ROD	STANDARD PACKAGE
112510	10	Brick	3/8 in. or 1/2 in. diameter iron	25
112521	21	Wood	3/8 in. or 1/2 in. diameter iron	25



281530

Awning Hardware – Head Rod Clamp – For Narrow Base Installation – Aluminum

One countersunk hole provided for wood screw. Extra strong aluminum bolts and non-ferrous zinc wing nuts.

ITEM #	STYLE #	FOR	STANDARD PACKAGE
281530	30A-40	1/2 in. rod	25



281510

Awning Hardware – Head Rod Clamp – For Brick Or Stone – Aluminum

Furnished with hole for 3/8 inch diameter lag. Includes machine screw and wing nuts.

ITEM #	STYLE #	FOR	STANDARD PACKAGE
281510	10A-4	1/2 in. rod	25



281501

Awning Hardware – Head Rod Clamp – For Wood – Aluminum

Furnished with two countersunk holes to accommodate No. 10 wood screws. Includes machine screw and wing nuts.

ITEM #	STYLE #	FOR	STANDARD PACKAGE
281501	03	3/8 in. rod	25
281505	5A-1	3/8 in. rod	25
281506	6A-2	1/2 in. rod	25



281505



140104

Awning Hardware – Rod And Rafter Holder No. 4

Rod and rafter holders are designed for attaching heads and rafters of patio or stationary awnings, eliminating the need for separate clamps for head rod or hinges for the rafters. Made of plated, malleable iron. Furnished with machine bolt and wing nut to hold the head rod, machine screw and square nut, for fastening the rafter.

A combination fixture for application on brick, wood or concrete. It has two countersunk holes for wood screws. There is also a hole for a 5/16 inch or 3/8 inch lag screw. The No. 4 Rod and Rafter Holder is especially suitable for application and installation on narrow trim boards.

ITEM #	STYLE #	SIZE HEAD ROD	STANDARD PACKAGE
140104	4	1/2 in. diameter iron	25



284093

Awning Hardware – Bracket Hinge – Aluminum

For wood. Two countersunk holes for wood screws. Furnished with machine screw. Also available in zinc die-cast.

ITEM #	STYLE #	PROJECTION	STANDARD PACKAGE
284093	OBA-3	1 in.	25



286204

Awning Hardware – Swivel Eye Pulley – Aluminum Die Cast

Aluminum die cast with stainless steel pin.

ITEM #	STYLE #	ROPE DIAMETER	SHEAVE DIAMETER	STANDARD PACKAGE	STYLE SHEAVE
286204	1A	3/16 in.	1/2 in.	25	Single
286212	11A	3/16 in.	1/2 in.	25	Double



286212



157500

Awning Hardware – Swivel Eye Pulley – Stamped

Stamped aluminum with an aluminum pin. Rustproof with smooth rounded top section housing to keep swivel eye from contact with rope. ABS plastic sheaves rotate freely on aluminum rivet.

ITEM #	STYLE #	ROPE DIAMETER	SHEAVE DIAMETER	STANDARD PACKAGE	STYLE SHEAVE
157500	60	1/8 in.	1/2 in.	100	Single
157501	61	3/16 in.	5/8 in.	100	Single
157502	62	3/16 in.	27/32 in.	100	Single



266678

Awning Hardware – Pulley – Malleable Iron

Plated malleable iron.

ITEM #	STYLE #	ROPE DIAMETER	STANDARD PACKAGE	STYLE SHEAVE
266678	5	3/8 in.	25	Single



284106

Awning Hardware – Rod And Rafter Holders – Dual Duty – Aluminum

Made to take 1/2 inch head rod. Designed to mount with either wood screws or lag bolt. Furnished with machine screws and wing nut.

ITEM #	STYLE #	FOR	STANDARD PACKAGE
284106	99A-99	1/2 in. rod	25



284103

Awning Hardware – Rod And Rafter Holders – For Brick Or Wood – Aluminum

Rod and Rafter Holders furnished with machine screws and wing nut. Also available in iron.

ITEM #	STYLE #	FOR	STANDARD PACKAGE
284103	3A-89	1/2 in. rod	25



113234

Awning Hardware – Slip-Fit Tie-Down Clamp

Trivantage® Slip-Fit fittings, made of sturdy, plated, shockproof malleable iron, or plated steel as shown, offer a time and labor saving way to install patio awnings. No threading necessary, as all fittings simply slip on or over pipe frame, and are then secured by means of square head set screws. Slip-Fit fittings permit rapid adjustment when pipe is not cut to exact length.



113236

Plated, stamped steel with stainless steel bolt. Tie-down clamps are designed to eliminate pocketing of rain water on stationary or terrace awnings. Their use permits stationary awning covers to be drawn taut. Assembly can be made quickly on new stationary awning frames as well as old ones. Furnished with carriage bolt and hex nut.

ITEM #	STYLE #	FRONT BAR SIZE	STANDARD PACKAGE
113233	33	3/4 in. pipe	25
113234	34	1 in. pipe	25
113236	34A	1 in. pipe	25
113235	35	1-1/4 in. pipe	25

113236 - The longer projection of this pipe clamp allows the installer to pull the fabric tighter on the frame. A 2-1/4 inch tabling must be used on the 34A for the installer to achieve the proper torque. Furnished with 2 carriage bolts and flange nuts.

Trivantage® is a registered trademark of Glen Raven, Inc.



281700

Awning Hardware – Slip-Fit Tie-Down Clamp – Aluminum

Slip-fit tie-down clamps prevent water pockets behind the front bar. This clamp fastens to the front bar and holds a 3/8 inch pipe or 5/8 inch rod. Furnished with machine bolt and hex nut. Also available in steel.

ITEM #	STYLE #	FOR	STANDARD PACKAGE
281700	77	3/4 in. pipe	25
281699	78	1 in. pipe	25



287803

Awning Hardware – Slip-Fit Adjustable Post Socket – For Brick – Aluminum

Furnished with square head set screw for slip-fit installation.

ITEM #	STYLE #	PIPE	STANDARD PACKAGE
287803	3A-205L	3/4 in. Slip-Fit	25
287804	4A-206L	1 in. Slip-Fit	25



215020

Awning Hardware – Slip-Fit Coupling

Trivantage® Slip-Fit fittings, made of sturdy, plated, shockproof malleable iron, or plated steel as shown, offer a time and labor saving way to install patio awnings. No threading necessary, as all fittings simply slip on or over pipe frame, and are then secured by means of square head set screws. Slip-Fit fittings permit rapid adjustment when pipe is not cut to exact length.

ITEM #	STYLE #	FINISH	FRONT BAR SIZE	MATERIAL	STANDARD PACKAGE
215020	14-6	Galvanized	1 in. pipe	Iron	25

Trivantage® is a registered trademark of Glen Raven, Inc.



163704

Awning Hardware – Slip-Fit Adjustable Post Socket – For Brick – Malleable Iron

Trivantage® Slip-Fit fittings, made of sturdy, plated, shockproof malleable iron, or plated steel as shown, offer a time and labor saving way to install patio awnings. No threading necessary, as all fittings simply slip on or over pipe frame, and are then secured by means of square head set screws. Slip-Fit fittings permit rapid adjustment when pipe is not cut to exact length.

Furnished with two lag screw holes for attaching to brick. Plated, malleable iron, furnished with set screw. Also available in aluminum.

ITEM #	STYLE #	SIZE POST	STANDARD PACKAGE
163703	3	3/4 in. pipe	25
163704	4	1 in. pipe	25

Trivantage® is a registered trademark of Glen Raven, Inc.



174375



174377

Awning Hardware – Slip-Fit Tee

Trivantage® Slip-Fit fittings, made of sturdy, plated, shockproof malleable iron, or plated steel as shown, offer a time and labor saving way to install patio awnings. No threading necessary, as all fittings simply slip on or over pipe frame, and are then secured by means of square head set screws. Slip-Fit fittings permit rapid adjustment when pipe is not cut to exact length.

Plated, malleable iron. Special cast lip on inside of slip tee prevents inserted pipe from interfering with pipe crossing in other direction. Can be used for: joining upright posts to front bars, joining rafters to front bars, joining special types of frames, such as carports, carnival booths, etc. Furnished with set screws.

ITEM #	STYLE #	EXTENSION	FRONT BAR SIZE	STANDARD PACKAGE
174375	275	1/2 in. pipe	1/2 in. pipe	25
174377	277	3/4 in. pipe	3/4 in. pipe	25
174379	279	1 in. pipe	1 in. pipe	25
225121	25-2	3/4 in. pipe	3/4 in. pipe	25
274030	25-7	1-1/4 in. pipe	1-1/4 in. pipe	25

274030 - Hot dip galvanized – does not have cast lip, with socket head screw.

Trivantage® is a registered trademark of Glen Raven, Inc.



163702

Awning Hardware – Slip-Fit Adjustable Post Socket – For Wood – Malleable Iron

Trivantage® Slip-Fit fittings, made of sturdy, plated, shockproof malleable iron, or plated steel as shown, offer a time and labor saving way to install patio awnings. No threading necessary, as all fittings simply slip on or over pipe frame, and are then secured by means of square head set screws. Slip-Fit fittings permit rapid adjustment when pipe is not cut to exact length.

Furnished with four wood screw holes for attaching to wood. Plated, malleable iron, furnished with set screw.

ITEM #	STYLE #	SIZE POST	STANDARD PACKAGE
163701	1	3/4 in. pipe	25
163702	2	1 in. pipe	25

Trivantage® is a registered trademark of Glen Raven, Inc.



173504

Slip Tee

Plated, malleable Iron. The run is not threaded and can be slipped over the front bar. The extension outlet is tapped.



173604

ITEM #	STYLE #	EXTENSION BAR THREADED	FRONT (SLIP FIT)	STANDARD PACKAGE	TYPE
173504	4	3/4 in. pipe	3/4 in. pipe	25	Without set screws
173604	4	3/4 in. pipe	3/4 in. pipe	25	With set screws
173622	22	1/2 in. pipe	1/2 in. pipe	25	With set screws



288144

Awning Hardware – Slip-Fit Rafter And Upright Tees

Designed for quick and efficient slip-fit installation at rafter and front bar.



288147

Connect No. 600 and No. 601 slip tees to create corners. These rafter and upright slip tees for 1 inch Schedule 40 pipe are adjustable to 90°. Use interchangeable No. 600's together for other areas. All slip tees are furnished with stainless steel set screws.

ITEM #	STYLE #	FOR	STANDARD PACKAGE
288144	600	1 in. x 1 in. pipe	25
288147	601	1 in. x 1 in. pipe	25

288144 - Replaces the 53A-311 and 43A-312.



138002

Awning Hardware – Spear Head

Supplied in standard plain finish or plated, ductile iron.



138102

ITEM #	STYLE #	DESCRIPTION	SIZE	STANDARD PACKAGE	THREADED FOR SIZE
138002	2	Plain	9-1/2 in.	25	1/2 in. pipe
138102	2	Plated	9-1/2 in.	25	1/2 in. pipe



283902

Awning Hardware – Spear Head – Aluminum

Spear head with male threaded ends.

ITEM #	STYLE #	LENGTH	STANDARD PACKAGE	THREADED FOR PIPE SIZE
283902	2A-103	8-1/2 in.	25	1/2 in. male thread

Awning Hardware – Pipe Clamp – Wrought Steel

Plated. Designed for a carriage bolt to prevent bolt head from turning when nut is tightened. Bolt included unless stated otherwise.

ITEM #	STYLE #	DESCRIPTION	BOLT SIZE	PIPE	STANDARD PACKAGE
112833	43	Bolt excluded	5/16 in.	3/4 in.	25
112834	44	Bolt excluded	5/16 in.	1 in.	25
112842	42	Bolt included	5/16 in.	1/2 in.	25
112843	43	Bolt included	5/16 in.	3/4 in.	25
112844	44	Bolt included	5/16 in.	1 in.	25
112848	43	Bolt included	3/8 in.	3/4 in.	25
112849	44	Bolt included	3/8 in.	1 in.	25



138615

Awning Hardware – Bracket Hinge

Plated, die-cast zinc. Furnished with machine screw and hex nut. Also available in aluminum.

ITEM #	STYLE #	PROJECTION	STANDARD PACKAGE
138615	O-B	1 in.	25



138737

Awning Hardware – Camelback Hinge – Zinc Die-Cast

Plated, zinc die-cast. Fastens the projection arms of awning frames to a building. Furnished with machine screws.



238020

No. 11 is identical in design to the No. 2, but has a round head shoulder screw with "pilot" for holding No. 1 Sheet Brass Grommets.

ITEM #	STYLE #	PROJECTION	STANDARD PACKAGE
138737	11	11/16 in.	25
238020	2	11/16 in.	25

238020 - Also available in aluminum.



263913

Awning Hardware – Round Head Machine Screw



263923

ITEM #	DESCRIPTION	FOR	MATERIAL	SIZE	STANDARD PACKAGE
263913	Round Head Machine Screw	No. 11 and C.B. Hinge	Plated	12-24 x 7/8 in.	100
263923	Round Head Shoulder Screw	No. 2 C.B. Hinge, No 34. S.S. Hinge	Stainless Steel	12-24 x 3/4 in.	100

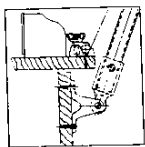

Awning Hardware – Extra Projection Hinge

Made of plated, malleable iron. Designed for box type awning or casement windows. Extra projection allows awning frame to fold flat against building. Pipe clamps on lower frame are easily moved to align frame with building. Also designed for ranch-type homes for use on ceiling of “overhang” when standard rod and rafter holder would not be suitable. Used with No. 30 Head Rod Clamp with fastening holes and shipped with Round Head Machine Screw.



139180

ITEM #	STYLE #	PROJECTION	STANDARD PACKAGE
139180	15	1-1/2 in.	25



139064

Awning Hardware – Hinge – Stamped Steel

Plated. Furnished with machine screw.

ITEM #	STYLE #	GAUGE	STANDARD PACKAGE
139064	34	14	25



124504

Awning Hardware – Jaw End With Lag Screw

Used to attach awning frame to a brick surface. Furnished with machine screw and square nut. Projection is from shoulder of jaw to center of bolt hole in jaw.

ITEM #	STYLE #	JAW OPENING	LAG SCREW SIZE	MATERIAL	PROJECTION	STANDARD PACKAGE	USE EXPANSION SHIELD
124504	4	7/16 in.	3/8 in. x 2-1/2 in.	Aluminum Extrusion	1-1/2 in.	25	3/8 in. x 2 in.



267301

Awning Hardware – Hinge Silencer Spring

Easily installed between the eye end of the awning frame and the hinge to absorb play and eliminate noise and rattle. Made of fine quality plated, tempered strip steel.

ITEM #	STANDARD PACKAGE
267301	25



136002

Gudgeon – Square Hole

For worm gears. For round shaft of center support.

ITEM #	FOR	STANDARD PACKAGE
136002	1-1/2 in. ID pipe	1



106708

Winding Brace

Made of rigid plated steel with steel socket for 5/8 inch iron pipe. Fitted with 4 inch hardwood grip handles.

ITEM #	STYLE #	BRACE SWEEP	SIZE	STANDARD PACKAGE
106708	8	14 in.	5/8 in.	1



141001

Worm Gear Attachments – Combination Coupling And Hook

Specially designed plated, malleable iron hook to securely engage eye of winding shaft when operating awning with winding brace. Standard equipment on all Trivantage® gears. Slips over 3/4 in. steel shaft. Furnished with round head machine screw.

ITEM #	STYLE #	STANDARD PACKAGE
141001	1	25



147002

Worm Gear Attachments – Universal Or Knuckle Joint

Used for connecting worm gear drive shaft or for splicing two drive shafts. Made of plated, malleable iron sockets with steel, square knuckles.

ITEM #	STYLE #	FOR	STANDARD PACKAGE
147002	2	3/4 in. x 3/4 in. iron	25



126001

Worm Gear Attachments – Winding Shaft Eye

Reinforced, plated, malleable iron eye, easily attaches to winding shaft with M6 (metric) bolt.

ITEM #	STYLE #	FOR	STANDARD PACKAGE
126001	1	1/2 in. iron	25
126002	2	5/8 in. iron	25
126003	3	3/8 in. pipe	25



158342

Pulley – Stamped Steel – Swivel Eye

ABS Plastic Single Sheave. Full-bearing, with heavy wire, open end swivel eyes that function smoothly. Sheaves prevent rope from being cut or frayed. Plated.

ITEM #	STYLE #	PUT UP	ROPE DIAMETER	SHEAVE DIAMETER	STANDARD PACKAGE	STYLE SHEAVE
158340	50		1/8 in.	1/2 in.	25	Single
158341	100		3/16 in.	5/8 in.	25	Single
158342	300	1	1/4 in.	1 in.	25	Single

158340 - Also available in aluminum.

158341 - Also available in aluminum.



256103

Pulley – Swivel Eye

Made with high grade cast iron swivel eyes and bodies, steel rivets and steel sheaves. Nickel-plated and lacquered for extra rust protection.

ITEM #	STYLE #	ROPE DIAMETER	SHEAVE DIAMETER	STANDARD PACKAGE	STYLE SHEAVE
256103	1	3/16 in.	3/4 in.	25	Single
256104	2	3/16 in.	3/4 in.	25	Double
256105	3	1/4 in.	1 in.	25	Single
256106	3/0	1/8 in.	1/2 in.	25	Single
256107	4/0	1/8 in.	1/2 in.	25	Double
256101	5	3/8 in.	1-1/4 in.	25	Single
256102	6	3/8 in.	1-1/2 in.	25	Double

256103 - Also available in aluminum.

256104 - Also available in aluminum.

256105 - Also available in aluminum.



256102



274819

Tip – Rubber

Eliminates damage or wear on fabric end curtains of patio awning where a Tie-Down Bar is used. Slips over ends of pipe used on roller curtains, to prevent end of pipe from chafing side of house. Can also be used on mooring poles to prevent marring boat floor.

ITEM #	STYLE #	DESCRIPTION	COLOR	FOR	STANDARD PACKAGE
476095	18	Tip with Stud	White	3/4 in. tubing	1
274817	17	Tip	Black	5/8 in. tubing, 3/8 in. pipe	10
274819	19	Tip	Black	7/8 in. tubing, 1/2 in. pipe	10
274815	18	Tip	White	3/4 in. tubing	10
274816	17	Tip	White	5/8 in. tubing, 3/8 in. pipe	10
274818	19	Tip	White	7/8 in. tubing, 1/2 in. pipe	10

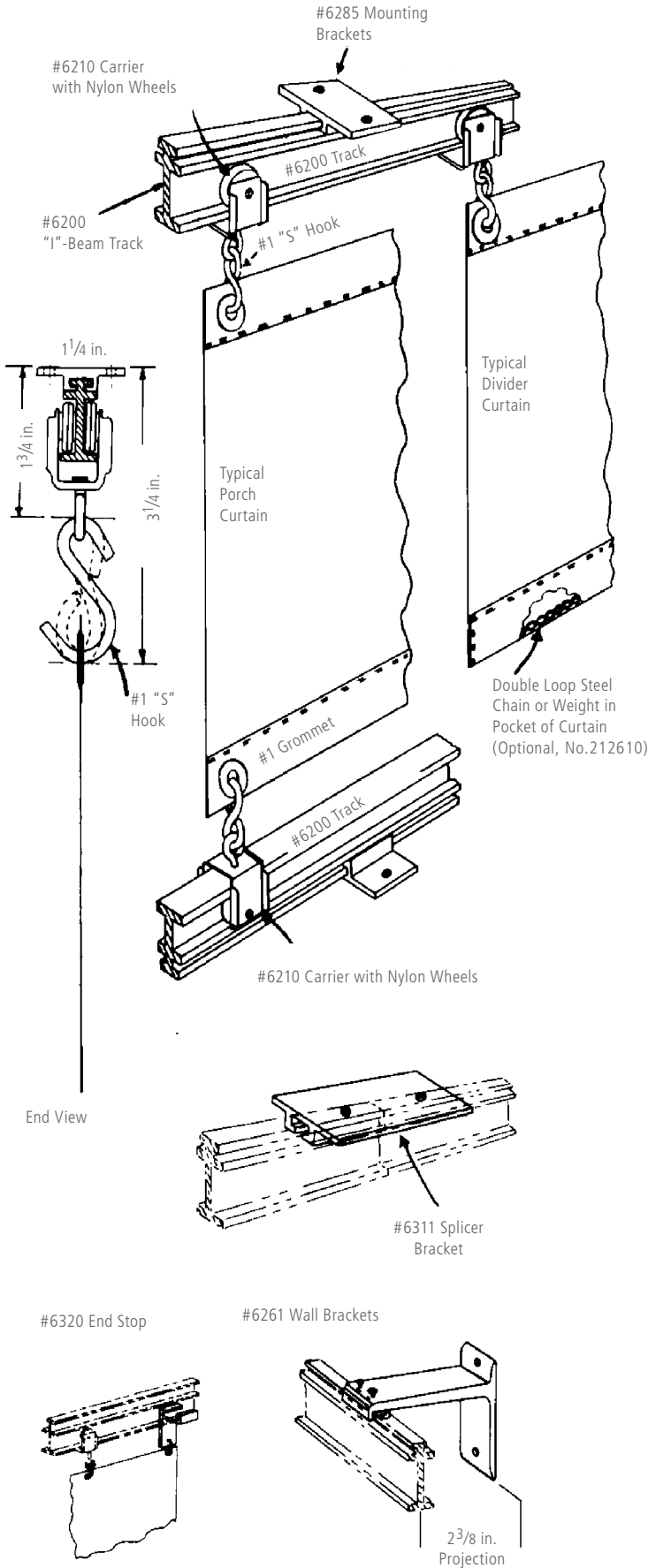

Track – Lightweight Aluminum Track No. 6200

A versatile, lightweight, aluminum track of sturdy "I" Beam construction. Excellent for installation and operation of any width fabric curtain up to 12 foot high. The streamlined design of this extruded aluminum track provides a sturdy construction and attractive appearance. The track can be bent manually to form curves of any radius greater than 6 inches. Friction-free nylon wheel carriers, normally spaced 12 inches apart, have heavy metal eyes accommodating Trivantage® No. 1 "S" Hooks to secure grommet in curtain to the carrier. For installation, the Trivantage No. 6200 Track is supported by slip-on brackets that are easily mounted to ceiling or wall. Slip-on track splicers and end stops can be easily installed on the job.

Mounting bracket #6285 is for attachment directly to ceiling and should be spaced 2 feet 6 inches to 3 feet apart. Wall mounting bracket #6261 provides 2-3/8 inches of projection from wall and should be spaced 2 feet 6 inches apart.

The zinc-plated steel carrier #6210 with zinc-plated steel swivel eye is normally spaced 12 inches apart.

Splicer bracket #6311 slips over top of track and locks two sections together with set screws. End stop #6320 is a slip-on attachment for track ends.

Recommended for interior use only.

ITEM #	STYLE #	DESCRIPTION	STANDARD PACKAGE
211410	6210 Part 2-67	Carriers with Nylon Wheels	100
206815	6285 Part 2-55	Ceiling Mounting Bracket	50
268320	6320 Part 2-55	End Stop	20
275621	6200	I-Beam Track 12 ft.	60 ft.
267141	6311 Part 2-55	Splicer Bracket	10
206821	6261 Part 2-55	Wall Mounting Bracket	40

Trivantage® is a registered trademark of Glen Raven, Inc.



Track – Steel Curtain Track System – 12 Gauge – Roller Track

Create privacy and partitions with the Trivantage® line of curtain hardware. This 12 gauge galvanized steel system includes a range of products that suspend and anchor the curtain system, as well as a variety of trolleys that allow the curtains to roll.

ITEM #	STYLE #	DESCRIPTION	GAUGE	LENGTH	MATERIAL	STANDARD PACKAGE
206838	12RT-240	Track	12	20 ft.	Galvanized Steel	200

Trivantage® is a registered trademark of Glen Raven, Inc.

Track – Steel Curtain Track System – 12 Gauge – Industrial Curtain Trolley

Create privacy and partitions with the Trivantage® line of curtain hardware. This 12 gauge galvanized steel system includes a range of products that suspend and anchor the curtain system, as well as a variety of trolleys that allow the curtains to roll.

ITEM #	STYLE #	DESCRIPTION	GAUGE	STANDARD PACKAGE
206836	12SR2-1/2(1/4)	Two-Wheel Trolley with Steel Wheels	12	1

Trivantage® is a registered trademark of Glen Raven, Inc.



206837

Track – Steel Curtain Track System – 12 Gauge – Track Splice

Create privacy and partitions with the Trivantage® line of curtain hardware. This 12 gauge galvanized steel system includes a range of products that suspend and anchor the curtain system, as well as a variety of trolleys that allow the curtains to roll.

ITEM #	STYLE #	DESCRIPTION	GAUGE	STANDARD PACKAGE
206837	12TSWMU	Splice Wall Mount Up 4 in.	12	10

Trivantage® is a registered trademark of Glen Raven, Inc.

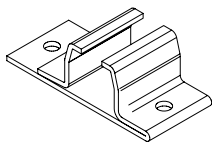

206861

Track – Steel Curtain Track System – 16 Gauge – Ceiling Support Brackets

Create privacy and partitions with the Trivantage® line of curtain hardware. This 16 gauge galvanized steel system includes a range of products that suspend and anchor the curtain system, as well as a variety of trolleys that allow the curtains to roll.

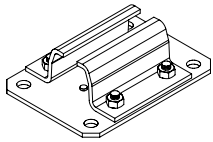

206865

Track can be attached to the ceiling support hardware either before or after it is secured to the ceiling. There are no screws or nuts to hold the track in place protruding above the mounting plates. This eliminates the need for spacers or clearance holes in the ceiling. Ceiling support mounting plates (except the 16TBC, item# 206861) have bosses to lock the track in the ceiling support mounting hardware.

ITEM #	STYLE #	DESCRIPTION	GAUGE	STANDARD PACKAGE
206861	16TBC	Ceiling Bracket	16	10
206865	16TSC	Ceiling Bracket	16	10

Trivantage® is a registered trademark of Glen Raven, Inc.



Track – Steel Curtain Track System – 16 Gauge – Curved Track

The standard curved track has end connectors for securing to adjacent sections of the roller track. The standard curve has a two-foot 90-degree radius.

ITEM #	STYLE #	DESCRIPTION	GAUGE	STANDARD PACKAGE
206854	16CT	Curved Track – 90 degree 2 ft. radius	16	25

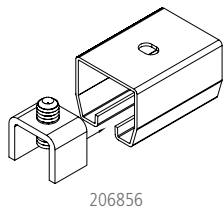

Track – Steel Curtain Track System – 16 Gauge – End Stops

End stops are used to prevent trolleys from rolling out of the ends of the track system.

ITEM #	STYLE #	GAUGE	STANDARD PACKAGE
206856	ES	16	50

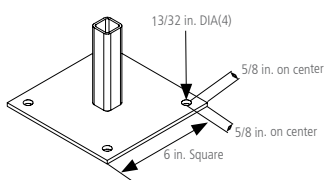

206843

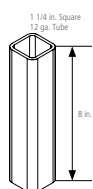

206842

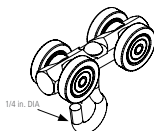

206870

Track – Steel Curtain Track System – 16 Gauge – Industrial Curtain Trolley

Create privacy and partitions with the Trivantage® line of curtain hardware. This 16 gauge galvanized steel system includes a range of products that suspend and anchor the curtain system, as well as a variety of trolleys that allow the curtains to roll.

Industrial curtain trolley is designed for larger, heavier curtains.

Two wheel trolleys with bumpers should be used in applications where the wheels of consecutive bumperless trolleys would rub together. In this case, the trolley frame extends beyond the outer portion of the wheel acting as a bumper. When the curtain weight exceeds 100 pounds or the curtain height is over 15 feet, steel ball bearing wheels should be used.

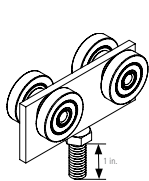

206867

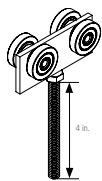

206878

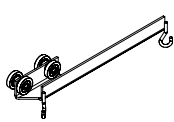

206845

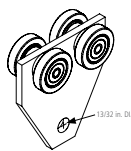

206881

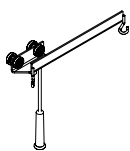

206834

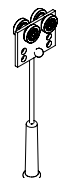

206839

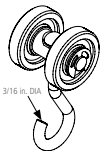

206868

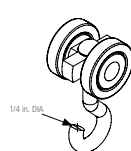

206869

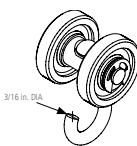

206835

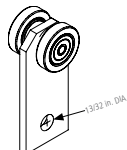

206877

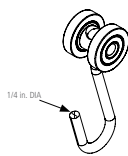

207880



206844

ITEM #	STYLE #	DESCRIPTION	STANDARD PACKAGE
206843	BS6	Base Plate	1
206842	A256-8	Floor Column Square – 8 ft.	1
206870	16ST1	Four-Wheel Trolley and Steel Wheels – 1" Hook	1
206867	16STS-4	Four-Wheel Trolley with Bumper and Steel Wheels – 1" Bolt	10
206878	16STS-4	Four-Wheel Trolley with Bumper and Steel Wheels – 4" Bolt	10
206845	16OT	Four-Wheel Trolley with Overlapping Wheels	1
206881	16ST	Four-Wheel Trolley with Plate	1
206834	B3491-10	Overlapping Trolley with Steel Wheels and Pull Rope – 10 ft.	1
206839	B3427-10	Trolley with Pull Rope – 10 ft.	1
206868	16NR1B	Two-Wheel Trolley with Bumper and Nylon Wheels	1
206869	16SR1B	Two-Wheel Trolley with Bumper and Steel Wheels	1
206866	16NR1	Two-Wheel Trolley with Nylon Wheels	5
206835	16NR-1/2	Two-Wheel Trolley with Nylon Wheels	1
206877	16SR	Two-Wheel Trolley with Rectangular Plate and Steel Wheels	1
207880	16SR2-1/2(1/4)	Two-Wheel Trolley with Steel Wheels	1
206844	16SR1	Two-Wheel Trolley with Steel Wheels	1

Trivantage® is a registered trademark of Glen Raven, Inc.

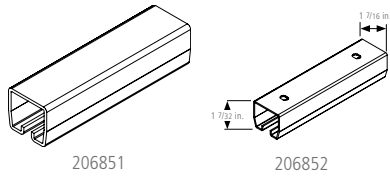

Track – Steel Curtain Track System – 16 Gauge – Roller Track

The roller track is roll formed from 16 gauge hot dipped galvanized steel. The trolley wheels roll on the track floor between the outside track wall and the inside safety flange. The ends of the track are punched so that the track splices can lock two adjoining track ends together.

ITEM #	STYLE #	GAUGE	LENGTH	MATERIAL	STANDARD PACKAGE
206851	16RT-120	16	10 ft.	Galvanized Steel	250
206852	16RT-240	16	20 ft.	Galvanized Steel	200

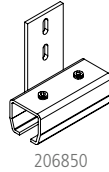

Track – Steel Curtain Track System – 16 Gauge – Components

ITEM #	STYLE #	DESCRIPTION	STANDARD PACKAGE
206850	16TSMUSS	Splice Wall Mount Up – 4 in.	10

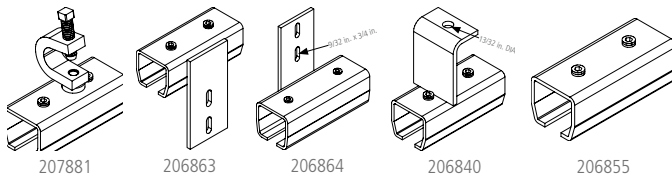

Track – Steel Curtain Track System – 16 Gauge – Track Splice

The track splice is used to secure two straight sections of track together.

ITEM #	STYLE #	DESCRIPTION	GAUGE	MATERIAL	STANDARD PACKAGE
207881	16TSEC	Edge Clamp	16	Galvanized Steel	1
206863	16TSWMD	Splice Wall Mount Down – 4 in.	16	Galvanized Steel	10
206864	16TSWU	Splice Wall Mount Up – 4 in.	16	Galvanized Steel	10
206840	16TSTR	Splice with Angle Bracket	16	Galvanized Steel	1
206855	16TS	Splice – 4 in. with 2 Set Screws	16	Galvanized Steel	10

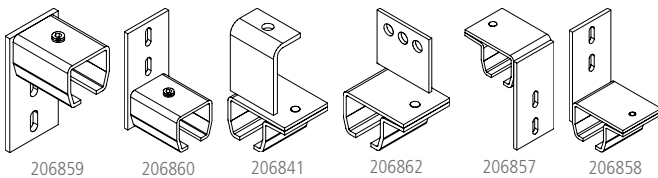

Track – Steel Curtain Track System – 16 Gauge – Wall Mount And End Mount Brackets

Wall mount and end mount brackets are used when the track system is running adjacent to a wall.

ITEM #	STYLE #	DESCRIPTION	GAUGE	STANDARD PACKAGE
206859	16EMD	End Mount Down	16	10
206860	16EMU	End Mount Up	16	10
206833	16TBATR	Right Angle Threaded Rod Bracket	16	1
206841	16TBTR	Threaded Rod Bracket	16	1
206862	16TBV	Vertical Bracket	16	10
206857	16TBWMD	Wall Mount Down	16	10
206858	16TBWU	Wall Mount Up	16	10

Porcelain Rings



260981

Porcelain Rings are manufactured with a strong and smooth finish for longer rope life. Gray color. Use clips shown below for suspending rings.

ITEM #	STYLE #	APPROXIMATE INSIDE DIAMETER	APPROXIMATE OUTSIDE DIAMETER	COLOR	SIZE	STANDARD PACKAGE
260981	1	3/4 in.	1-5/8 in.	Gray	Small	25
260982	2	1 in.	2 in.	Gray	Medium	25

Ring Clips



117201

ITEM #	STYLE #	FINISH	STANDARD PACKAGE	TYPE
117203	1	Plated Steel	25	Heavy
117201	2	Plated Steel	25	Standard
117205	3	Stainless Steel	25	

Chain – Double Loop Steel



212610

This galvanized steel chain is ideal for application in awning curtain pockets as a "weight" to prevent curtain from flapping in the wind. Also, practical for supporting "hanging canopies" and "stationary awnings", or as a chain lift on slide rod awnings, etc. Flexible and strongly made, heavy and of rigid galvanized steel wire.

ITEM #	STYLE #	STANDARD PACKAGE
212610	1/0	100 ft.

Cleat – Awning



214201

These rope cleats offer strong and durable design for outdoor use.

ITEM #	STYLE #	DRILLED FOR	FOR	LENGTH	MATERIAL	# OF HOLES	STANDARD PACKAGE
214201	1	No. 8 wood screw		4-1/2 in.	Zinc Die-Cast	2	25
266676	2	No. 10 wood screw		6 in.	Zinc Die-Cast	2	100
281702	2A-2		3/4 in. pipe	6 in.	Aluminum	2	25

Curtain Loop – Shower/Bath



249614

Nickel plated steel.

ITEM #	STYLE #	SIZE	STANDARD PACKAGE
249614	30570	1 in.	25

Hook – Roller



294650

For attaching a roller curtain to pipe, or tubing. Can be used for underneath an awning or canopy, or in a stand-alone application.

ITEM #	STYLE #	SIZE OPENING	STANDARD PACKAGE
294650	101	3/4 in. or 1 in. pipe	25



223680



223687

Disc And Prong

Brass discs and prongs with slightly larger dimensions. One set includes two discs and one prong.

ITEM #	DESCRIPTION	MATERIAL	STANDARD PACKAGE
223680	Prong	Brass	500
223687	Disc	Brass	1000

Fluorescent Eggcrate Louvers

Eggcrate louvers have a perimeter which allows continuous appearance mounting by overlapping factory edges. UV resistant.

Sold by full case only. Cannot ship UPS.

ITEM #	STYLE #	CELL SIZE	COLOR	MATERIAL	STANDARD PACKAGE
249700	10	1/2 in. x 1/2 in. x 1/2 in.	White	Acrylic	1
249705	14	1/2 in. x 1/2 in. x 3/8 in.	White	Acrylic	1
249710	20	1/2 in. x 1/2 in. x 1/2 in.	White	Styrene	1
249720	24	1/2 in. x 1/2 in. x 3/8 in.	White	Styrene	1

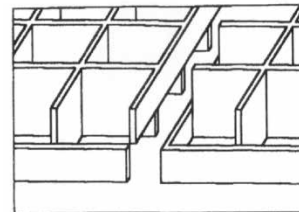
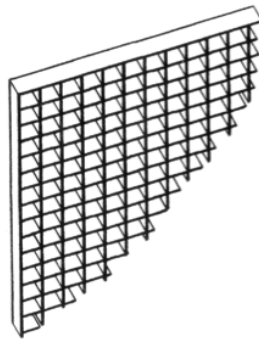

Eggcrate louvers have a perimeter which allows continuous appearance mounting by overlapping factory edges.



Bracket – Z

Awning frames can easily be mounted with these brackets. Made from 3/16 inch hot rolled steel, they are supplied plated, or plain (for applications requiring painting). Two holes spaced equally for lagging into mortar are provided to secure bracket to wall. There is also a 3/16 inch hole to accommodate a Teks® screw for fastening the frame. Will accommodate a 3/8 inch lag screw.



ITEM #	STYLE #	FINISH	LENGTH	ROUND TUBE SIZE	SQUARE TUBE SIZE	STANDARD PACKAGE	TYPE	WIDTH
107609	#0	Plain	2-1/8 in.	1.050 in.	1 in.	25	Mini	
107601	#2	Plain	4-3/4 in.	1.050 in.	1 in.	25	Medium	
107615	#3	Plain	4-13/16 in.	1.315 in.	1-1/4 in.	25	Large	
107610	#0	Plated	2-1/8 in.	1.050 in.	1 in.	25	Mini	
107606	#1	Plated	4-1/2 in.	0.840 in.	3/4 in.	25	Small	
107602	#2	Plated	4-3/4 in.	1.050 in.	1 in.	25	Medium	
107616	#3	Plated	4-13/16 in.	1.315 in.	1-1/4 in.	25	Large	
239955		Zinc Plated			1 in.	25	Large	
239954		Zinc Plated	2-1/4 in.		1 in.	25	Small	
206805	CF86	Zinc Plated	2-1/16 in.	1.029 in.	1 in.	25		1-1/2 in.

Teks® is a registered trademark of Illinois Tool Works, Inc.

Bracket – Joining



Frame joining brackets allow covered frame sections to be easily joined together without obvious and unsightly joints. Adjoining modular frame sections of different or identical heights, depths, and shapes will appear as one continuous awning when installed.

ITEM #	SIZE	STANDARD PACKAGE
107375	2 in.	25
239956	2 in.	25

Bracket – L



Made from 3/16 inch hot rolled steel. Two holes spaced equally for lagging into mortar are provided to secure bracket to wall. There is also a 3/16 inch hole to accommodate a Teks® screw for fastening the frame. Will accommodate a 3/8 inch lag screw.

ITEM #	STYLE #	FINISH	LENGTH	SQUARE TUBE SIZE	STANDARD PACKAGE	TYPE
107630	#10	Plated	1-9/32 in.	1 in. or 3/4 in.	25	Large

Teks® is a registered trademark of Illinois Tool Works, Inc.

Head Rod – Electro-Galvanized



In the bending process of making awning frames, this awning iron will not break when bent to right angles. The zinc plating will not chip or flake off during bending. Drawn to full sizes, the iron threads easily and exactly for perfect fitting with pipe-threaded frame fixtures. Also used for lacing and tie down bars, and in conjunction with head rod molding.

ITEM #	DIAMETER	LENGTH	# OF PIECES PER BUNDLE	STANDARD PACKAGE	WEIGHT PER BUNDLE	WEIGHT PER FOOT
244516	3/8 in.	20 ft.	17	17	128 lbs.	0.38 lbs.
244518	1/2 in.	20 ft.	12	12.03	160 lbs.	0.67 lbs.
244520	5/8 in.	20 ft.	5	5	105 lbs.	1.04 lbs.

Head Rod – Fiberglass

ITEM #	COLOR	# OF PIECES PER BUNDLE	SIZE	STANDARD PACKAGE
244616	White	5	3/8 in. x 20 ft.	100 ft. bundle
244625	White	15	1/2 in. x 20 ft.	300 ft. bundle



555 180° open molding

Molding – Aluminum Awning

A fast and easy way to install covers. Mill finish, all-aluminum molding that remains in place all year. 6063-T6 aluminum. Cover slides into place easily. 1/4 inch rope is sewn into hem at top of cover. Then, the rope-filled hem slips into the channel of the molding. Allows for easy installation and removal. PE Tubing, Vinyl Welt, or 8.5 m Keder Welt can also be used.

Product is also commonly known as “trailer” molding.

No. 555 Moldings are lighter in weight than No. 777, and are flexible enough to form and bend to varying shapes. Recessed mounting face conforms readily to uneven surfaces.



555 90° open molding

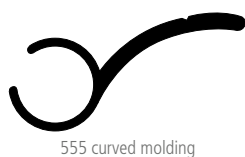

555 curved molding



777 molding

ITEM #	STYLE #	DEGREE OF CHANNEL	FLANGE SIZE	LENGTH	OVERALL HEIGHT	ROPE SIZE	STANDARD PACKAGE	THICKNESS	WEIGHT PER CARTON	WEIGHT PER FOOT
251008	555	180°	0.600 in.	18 ft.	1-1/8 in.	1/4 in. in hem	216 ft.	3/64 in.	27 lbs.	0.123 lbs.
251007	555	180°	0.600 in.	8 ft.	1-1/8 in.	1/4 in. in hem	72 ft.	3/64 in.	9 lbs.	0.123 lbs.
251018	777	45°	~0.500 in.	18 ft.	1-1/4 in.	1/4 in. in hem	216 ft.	3/64 in.	35 lbs.	0.160 lbs.
251017	777	45°	~0.500 in.	8 ft.	1-1/4 in.	1/4 in. in hem	72 ft.	3/64 in.	12 lbs.	0.160 lbs.
251010	555	90°	0.600 in.	18 ft.	1-1/8 in.	1/4 in. in hem	216 ft.	3/64 in.	27 lbs.	0.124 lbs.
251009	555	90°	0.600 in.	8 ft.	1-1/8 in.	1/4 in. in hem	72 ft.	3/64 in.	9 lbs.	0.124 lbs.
251001	555	90°	0.64 in.	20 ft.	1-1/8 in.	1/4 in. in hem	400 ft.	3/64 in.	78 lbs.	0.112 lbs.
275812	555	90°	0.625 in.	20 ft.	1-1/8 in.	1/4 in. in hem	600 ft.	3/64 in.		
251011	555 Curved	90°		8 ft.	1-1/8 in.	1/4 in. in hem	72 ft.	3/64 in.	10 lbs.	0.140 lbs.
251012	555 Curved	90°		18 ft.	1-1/8 in.	1/4 in. in hem	216 ft.	3/64 in.	30 lbs.	0.140 lbs.

Molding – Aluminum Awning – Bright Dipped

Birght dipped anodized aluminum.

ITEM #	STYLE #	DESCRIPTION	DEGREE OF CHANNEL	FINISH	LENGTH	STANDARD PACKAGE	WEIGHT PER FOOT
251050	A15	Molding	135 degrees	Bright Dipped Anodized	16 ft.	400 ft.	0.12 lbs.

Welting – Vinyl

Use in place of rope headers on awnings that attach to motor homes, travel trailers, campers and other recreational vehicles. Can be used in conjunction with aluminum awning molding or with the extruded channel already provided by many of the RV manufacturers.

ITEM #	STYLE #	COLOR	PUT UP	SIZE
578003	A02-002	White	300 ft.	31/32 in. with 5/16 in. bead
578004	A02-002	Black	300 ft.	31/32 in. with 5/16 in. bead
578098	6022	Black	100 ft.	31/32 in. with 5/16 in. bead



265757

Emseal UST Awning/Sign Sealant Tape

Why spend time caulking behind awning frames and suffer the frustration of messy jobs, dripped caulk and caulking in bad weather, when all you have to do is apply Awning Foam Sealant to the frame before it's hoisted on the wall?



265756

Available in dimensions to fit most building surfaces, this self-expanding polyester polyurethane foam is filled with water-based stabilized acrylics and will not dry out, shrink or deteriorate when compressed and properly installed. Just peel off the release liner and apply the adhesive side to the back of the awning. This is a continuous seal that is easy to install at ground level, thus providing a safer and more efficient installation atmosphere.



265755

ITEM #	BUILDING SURFACE	SIZE	STANDARD PACKAGE
265757	Commercial Grade Corrugated Metal	5/16 in. x 3/4 in. x 13.12 ft.	1
265756	Split Block	11/32 in. x 3/4 in. x 13.12 ft.	1
265755	Stucco, Block, Brick	5/32 in. x 5/8 in. x 26.24 ft.	1

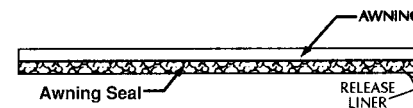
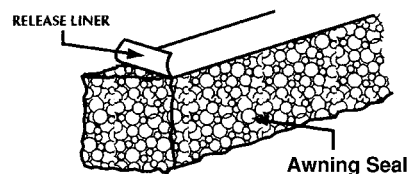

578054

Xtreme Seal® Awning Seal

Awning installations are a breeze with Xtreme Seal Awning Seal. Designed for the awning industry as a gasket material between the frame and the mounting surface, Xtreme Seal Awning Seal conforms to the contour of the mounting surface, eliminating the need for silicone and providing a clean finished product. Made of EPDM material, Xtreme Seal Awning Seal also features an adhesive back, saving time and making mounting easy. Available in full rolls only.

ITEM #	STYLE #	COLOR	PUT UP
578054	POD-AW	Black	250 ft.

Xtreme Seal® is a registered trademark of Xtreme Seal LLC.

Tubing "PE" – Low-Density Polyethylene

Polyethylene tubing for use in the head of awnings, and for marine and tonneau covers when using aluminum awning rail. Will not rot, absorb water, shrink, or unravel.

ITEM #	STYLE #	PUT UP	SIZE
515500	A02-005	1000 ft.	1/4 in. OD x 1/8 in. ID
578095	PEH8321000-6-SP	1000 ft.	1/4 in. OD x 1/8 in. ID

Molding – Head Rod Molding No. 35/37



117139



124538



124540

For installations at the head of stationary or patio awnings and for installation and adjustment of the rafters of patio awnings. Extruded from 6063-T6 aluminum - mill finish.

Nos. 35 and 37 Head Rod Moldings are designed for use with a 1/2 inch diameter conventional head rod to eliminate the awkward job of threading a rope-filled hem through a slot in the molding. The head rod is merely placed in position and finger clips are tightened to hold the head of the awning under the rainproof lip of the molding. The finger clips ride in a track in the molding and can be adjusted to move laterally right or left.

The advantage of this system is that rafters can be placed precisely, even if the surface is uneven or the mounting supports are not located where the rafters should be, because once the molding is mounted, the rafters can be slid to their proper location.

Recommended rafter spacing is 1 1/2 feet in from each side, and then 3 feet to 4 feet centers depending on projection (the longer the rafters, the less the spacing). Awning rafters are attached to special jaw ends that are mounted in a track in the lower side of the molding. The jaw ends can be moved laterally to adjust the rafter width. This is done by turning or

tightening the jaw end, which is fitted with a carriage bolt to ride in the same track as the finger clip.

The molding itself is designed so that a bead of caulking compound can be applied to the top length of the molding to prevent water from leaking behind the molding and down the wall.

The No. 35 Molding has the same basic design as the No. 37, but is 25% lighter in weight, with approximately 90% of the No. 37's strength. The No. 37 Finger Clip, No. 37W Jaw End and 1/2 inch Head Rod Clamp can be used with the No. 35 Molding without alteration.

ITEM #	STYLE #	DESCRIPTION	LENGTH	SIZE OUTSIDE DIAMETER	STANDARD PACKAGE	WEIGHT	WEIGHT PER FOOT
117139	37	Finger clip assembly. Stainless steel carriage bolt, machine screw, hex nut and washers.			25		
251100		Flat Bar	16 ft.	1 in. x 1/8 in.	320 ft.	41 lbs.	
251061	37WJB	Jaw End			25		
124538	37C	Jaw end with plated steel carriage bolt, machine screw, hex nut and washers.			25		
124540	37W	Jaw end with stainless steel carriage bolt, machine screw, hex nut and washers.			25		
251044	35	Molding	8 ft.		72 ft.	48 lbs.	
251049	35	Molding	20 ft.		160 ft.	107 lbs.	
251033	35JB	Molding	20 ft.		400 ft.		
251039	37	Molding	20 ft.		160 ft.	137 lbs.	
251037	37	Molding	12 ft.		144 ft.	123 lbs.	
251034	37	Molding	8 ft.		72 ft.	61 lbs.	
251032	37JB	Molding	20 ft.		320 ft.		0.640 lbs.

Trivantage® is a registered trademark of Glen Raven, Inc.

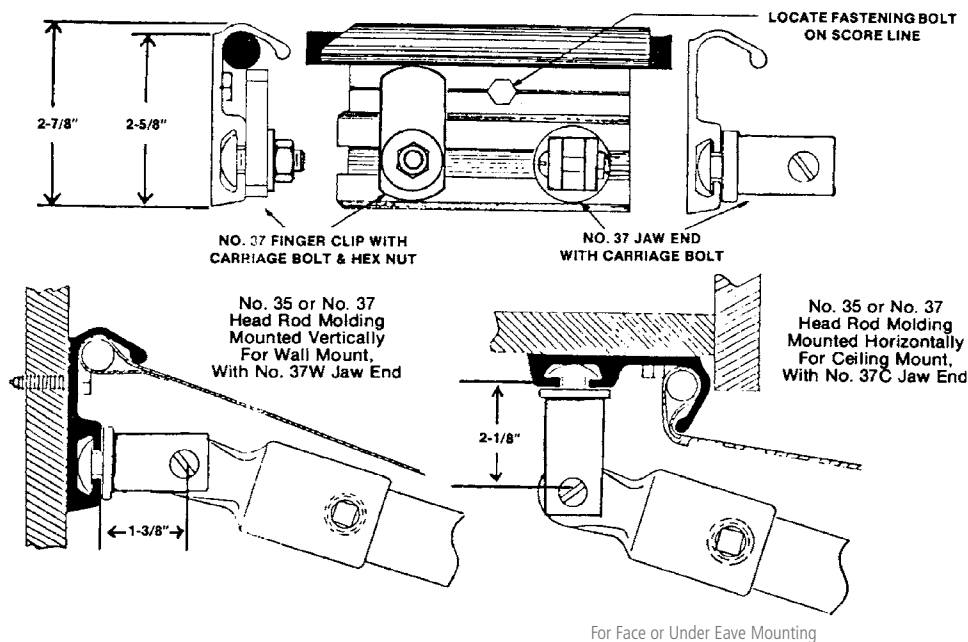



Molding – Dietz Head Rod Molding

Dietz Headrail is a lightweight, continuous head and rafter holder extruded from 6063-T6 mill finish aluminum designed to provide easy, leakproof installations that combine strength, attractiveness, and economy. The need for a headerboard is eliminated.

The trailer molding-type opening eliminates the need for iron and provides an easy method for sliding the fabric through the molding. Conventional 1/4 inch rope or tubing is recommended for sewing in the head.

Cast aluminum alloy hinges are inserted with a simple quarter turn. It is not necessary to insert hinges from the end, which allows for easy installation of extra rafters.

Two grooves to facilitate drilling are strategically placed to offset thrust of frame and shrinkage of canvas, as well as allow ample clearance for 3/8 inch lag bolts or keystone anchors for brick installations.

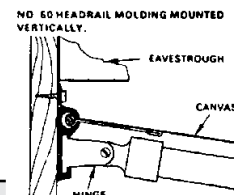
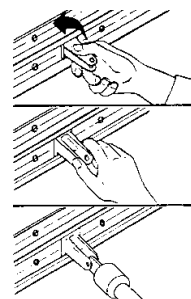

ITEM #	STYLE #	LENGTH	STANDARD PACKAGE
237250	60	12 ft.	72 ft.
238015	51		25

238015 - Includes nut and 1/4 inch bolt.



Tubing – Aluminum Square And Rectangular

Square and rectangular 6063-T6 extruded mill finish aluminum tubing for awning framing and sign boxes. Both forms are lightweight, and corrosion resistant, offering the best combination of strength, bending and welding characteristics.

ITEM #	LENGTH	SIZE	STANDARD PACKAGE
275900	20 ft.	1 in. x 1 in. x 0.060	80 ft.
275902	24 ft.	1 in. x 1 in. x 0.060	96 ft.
275905	20 ft.	1 in. x 1 in. x 0.125	80 ft.
275907	24 ft.	1 in. x 1 in. x 0.125	96 ft.
275911	20 ft.	1 in. x 2 in. x 0.060	80 ft.
275910	20 ft.	1 in. x 2 in. x 0.125	80 ft.
275913	20 ft.	2 in. x 2 in. x 0.125	80 ft.

Ceiling Panel Support Members

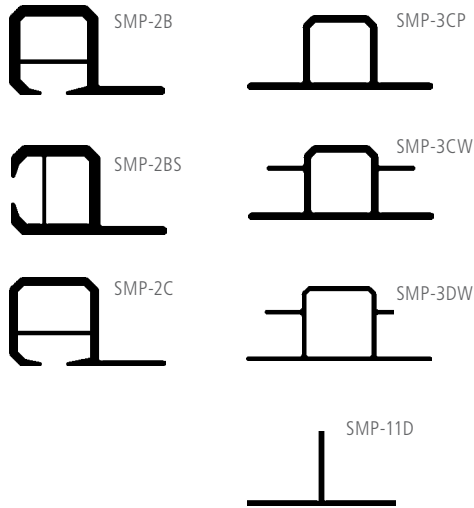

Channeled Stapling Members

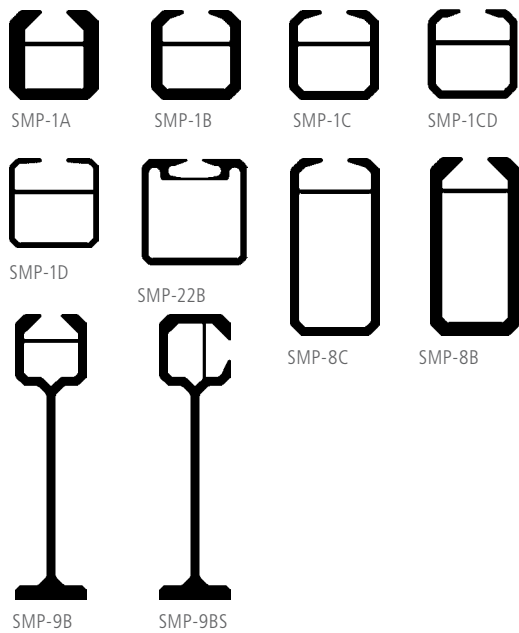

Support Members

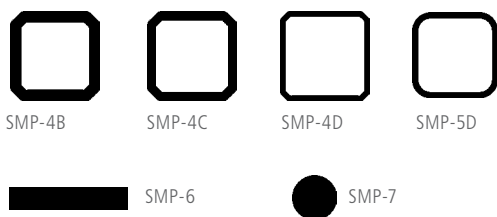

Steel Stitch™ Systems Extrusions Aluminum

The Steel Stitch System offers flexibility in design and fabrication of interior and exterior awnings, canopies and back-lit signs. The aluminum alloy 6063-T5 mill finish frame system utilizes the "staple-in" method of attaching fabric, which is taken directly from the roll and stapled into a channel in the frame. A PVC finishing trim is then driven into the channel to cover the staples. With the use of divider strips to join sections and the exclusive, patented FlashStrip®, which forms a watertight seal against building surfaces, the result is an attractive, seamless and wrinkle-free awning, canopy or sign.

ITEM #	STYLE #	DESCRIPTION	FEET PER BUNDLE	LENGTH	SIZE	STANDARD PACKAGE
250084	SMP-6	Aluminum Bar	200 ft.	20 ft.	1 in. x 3/16 in.	200
250086	SMP-7	Aluminum Rod	200 ft.	20 ft.	1/2 in. OD	200
250055	SMP-1CD	Tube	250 ft.	25 ft.	1 in. x 1 in. x 0.090 in.	250
250076	SMP-4C	Tube	200 ft.	20 ft.	1 in. x 1 in. x 1/10 in.	200
250078	SMP-4C	Tube	250 ft.	25 ft.	1 in. x 1 in. x 1/10 in.	250
250054	SMP-1C	Tube	250 ft.	25 ft.	1 in. x 1 in. x 1/10 in.	250
250080	SMP-4D	Tube	200 ft.	20 ft.	1 in. x 1 in. x 1/16 in.	200
250074	SMP-4B	Tube	200 ft.	20 ft.	1 in. x 1 in. x 1/8 in.	200
250052	SMP-1B	Tube	250 ft.	25 ft.	1 in. x 1 in. x 1/8 in.	250
250050	SMP-1A	Tube	250 ft.	25 ft.	1 in. x 1 in. x 3/16 in.	250
250064	SMP-2C	Tube	250 ft.	25 ft.	1 in. x 1-3/4 in. x 1/10 in.	250
250060	SMP-2BS	Tube	200 ft.	20 ft.	1 in. x 1-3/4 in. x 1/8 in.	200
250058	SMP-2B	Tube	250 ft.	25 ft.	1 in. x 1-3/4 in. x 1/8 in.	250
250062	SMP-2BS	Tube	250 ft.	25 ft.	1 in. x 1-3/4 in. x 1/8 in.	250
250091	SMP-8C	Tube	250 ft.	25 ft.	1 in. x 2 in. x 1/10 in.	250
250090	SMP-8B	Tube	250 ft.	25 ft.	1 in. x 2 in. x 1/8 in.	250
250070	SMP-3CW	Tube	200 ft.	20 ft.	1 in. x 2-1/2 in. x 1/10 in.	200
250068	SMP-3CP	Tube	200 ft.	20 ft.	1 in. x 2-1/2 in. x 1/10 in.	200
250092	SMP-9B	Tube	250 ft.	25 ft.	1 in. x 4 in. x 1/8 in.	250
250094	SMP-9BS	Tube	250 ft.	25 ft.	1 in. x 4 in. x 1/8 in.	250
275908	SMP-502	Tube	80 (mill)	20 ft.	1-1/2 in. x 1-1/2 in. x 1/8 in.	80
250097	SMP-15B	Tube	150 ft.	25 ft.	1-1/2 in. x 1-1/2 in. x 1/8 in.	150
250099	SMP-22B	Tube	150 ft.	25 ft.	2 in. x 2 in. x 1/8 in.	150
250096	SMP-10B	Tube	250 ft.	25 ft.	4 in. OD x 1/8 in.	250
250082	SMP-5D	Tube	200 ft.	20 ft.	7/8 in. x 7/8 in. x 1/16 in.	200

Steel Stitch™ is a trademark of Steel Stitch Corporation. FlashStrip® is a registered trademark of Steel Stitch Corporation.

GatorStitch™

GatorStitch is a superior strength frame tubing product that incorporates an aluminum stapling web embedded within a 1 inch galvanized steel tube. Like the Steel Stitch™ system, fabric is stapled into a channel of the GatorStitch frame, resulting in an attractive, seamless and wrinkle-free, drum-tight awning or sign.

Use this Steel Stitch product like you would the aluminum framing system with the same tools, pvc trim, and covering techniques. Save money on your material cost due to the superior strength and lower cost of steel. GatorStitch is fabricator-friendly and works with any awning or flex-face sign fabric, including woven acrylics, laminated and coated vinyls, polyester blends, and open mesh weaves. Fabric wear is reduced because of the systems fabric-to-frame attachment points. GatorStitch is 1 inch square and made of 18 gauge high strength steel having a maximum yield strength of 50,000 psi and tensile strength of 55,000 psi. Weld to existing steel for retrofits or large structures. Meet project specifications that call for steel framing.

Bending GatorStitch

GatorStitch can be bent with the stapling channel facing out using a standard 3-wheel roller bender. The minimum possible radius varies by machine and can be reduced by bending gradually in multiple passes.

GatorStitch Corrosion Protection

A triple layer of zinc, conversion coating, and clear epoxy protects the inside and outside surfaces of the steel and act as a barrier between the steel and the aluminum insert.

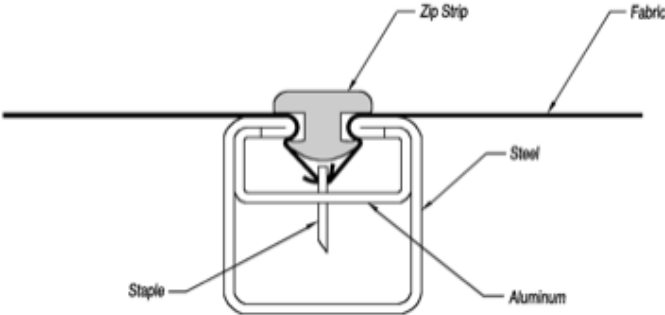

ITEM #	APPROXIMATE WEIGHT PER PIECE	FEET PER BUNDLE	GAUGE	LBS PER FOOT	LENGTH	PIECES PER BUNDLE	SHAPE	SIZE OUTSIDE DIAMETER	STANDARD PACKAGE	WEIGHT PER BUNDLE
276150	13.8 lbs.	1200 ft.	18	0.6891 lbs.	20 ft.	60	Square	1 in.	1200	833 lbs.

Gatorstitch™ is a trademark of Allied Tube & Conduit Corporation. Steel Stitch™ is a trademark of Steel Stitch Corporation.



249917

Steel Stitch™ ZipStrip®

Designed to cover the staples once the fabric has been stapled into position. Product is driven into the open channel using an air hammer.

ITEM #	COLOR	COLOR #	PUT UP	STANDARD PACKAGE
249916	Aquamarine	16	400 ft. rolls	400
250305	Beige	05	150 ft. rolls	150
249905	Beige	05	400 ft. rolls	400
250302	Black	02	150 ft. rolls	150
249902	Black	02	400 ft. rolls	400
250333	Bordeaux	33	150 ft. rolls	150
249934	Bordeaux	33	400 ft. rolls	400
249926	Bright Blue	26	400 ft. rolls	400
249930	Bright Orange	30	400 ft. rolls	400
250324	Bright Red	24	150 ft. rolls	150
249924	Bright Red	24	400 ft. rolls	400
250306	Brown	06	150 ft. rolls	150
249906	Brown	06	400 ft. rolls	400
250311	Burgundy	11	150 ft. rolls	150
249911	Burgundy	11	400 ft. rolls	400
250304	Cream	04	150 ft. rolls	150
249904	Cream	04	400 ft. rolls	400
250331	Crystal Clear	31	150 ft. rolls	150
249931	Crystal Clear	31	400 ft. rolls	400
250313	Dark Blue	13	150 ft. rolls	150
249913	Dark Blue	13	400 ft. rolls	400
250318	Dark Green	18	150 ft. rolls	150
249918	Dark Green	18	400 ft. rolls	400
250323	Deep Red	23	150 ft. rolls	150
249923	Deep Red	23	400 ft. rolls	400
250329	Golden Yellow	29	150 ft. rolls	150
249929	Golden Yellow	29V	400 ft. rolls	400
249917	Grass Green	17	400 ft. rolls	400
250303	Grey	03	150 ft. rolls	150

ITEM #	COLOR	COLOR #	PUT UP	STANDARD PACKAGE
249903	Grey	03	400 ft. rolls	400
250322	Linen	22	150 ft. rolls	150
249922	Linen	22	400 ft. rolls	400
249914	Medium Blue	14	400 ft. rolls	400
250310	Plum	10	150 ft. rolls	150
249920	Pumpkin	20	400 ft. rolls	400
250312	Rouge Red	12	150 ft. rolls	150
249912	Rouge Red	12	400 ft. rolls	400
250325	Royal Blue	25	150 ft. rolls	150
249925	Royal Blue	25	400 ft. rolls	400
249927	Teal	27	400 ft. rolls	400
250321	Terra Cotta	21	150 ft. rolls	150
249921	Terracotta	21	400 ft. rolls	400
249928	Turquoise	28	400 ft. rolls	400
250332	Violet	32	150 ft. rolls	150
249933	Violet	32	400 ft. rolls	400
250301	White	01	150 ft. rolls	150
249901	White	01	400 ft. rolls	400
250319	Yellow	19	150 ft. rolls	150
249919	Yellow	19	400 ft. rolls	400

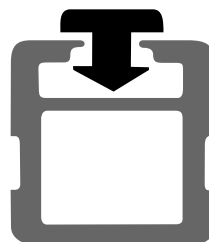

Steel Stitch™ is a trademark of Steel Stitch Corporation. ZipStrip® is a registered trademark of Steel Stitch Corporation.



249879



249873

Steel Stitch™ ZipStrip® – Sunbrella® Fabric

This fabric covered PVC staple channel trim creates a traditional finish on woven canvas awnings and canopies. Fabric covered ZipStrip is made with Sunbrella acrylic fabrics that completely conceal the PVC material. A durable lockstitch double seam holds the fabric securely in place for years of attractive performance. Custom colors and fabrics are available.

ITEM #	COLOR	COLOR #	PUT UP	STANDARD PACKAGE
249899	Alpine	6055	160 ft. rolls	160
249879	Beige	6020	160 ft. rolls	160
249877	Black Cherry	6040	160 ft. rolls	160
249878	Black	6008	160 ft. rolls	160
249891	Burgundy	6031	160 ft. rolls	160
249890	Cadet Grey	6030	160 ft. rolls	160
249896	Captain Navy	6046	160 ft. rolls	160
249894	Forest Green	6037	160 ft. rolls	160
249873	Jockey Red	6003	160 ft. rolls	160
249893	Linen	6033	160 ft. rolls	160
249876	Navy	6026	160 ft. rolls	160
249897	Oyster	6042	160 ft. rolls	160
249871	Pacific Blue	6001	160 ft. rolls	160
249875	Persian Green	6043	160 ft. rolls	160
249895	Seagrass Green	6045	160 ft. rolls	160
249881	Terracotta	6022	160 ft. rolls	160
249882	Toast	6028	160 ft. rolls	160
249880	True Brown	6021	160 ft. rolls	160

Steel Stitch™ is a trademark of Steel Stitch Corporation. ZipStrip® is a registered trademark of Steel Stitch Corporation. Sunbrella® is a registered trademark of Glen Raven, Inc.



249811

Steel Stitch™ ZipStrip® – Sunbrella® Fabric with Tenara® Thread

This fabric covered PVC staple channel trim creates a traditional finish on woven canvas awnings and canopies. Fabric covered ZipStrip is made with Sunbrella acrylic fabrics that completely conceal the PVC material. A durable lockstitch double seam of Tenara thread holds the fabric securely in place for years of attractive performance. Custom colors and fabrics are available.

ITEM #	COLOR	COLOR #	PUT UP	STANDARD PACKAGE
249825	Beige	4620	160 ft. rolls	160
249813	Black	4608	160 ft. rolls	160
249824	Brown	4621	160 ft. rolls	160
249816	Burgundy	4631	160 ft. rolls	160
249821	Cadet Grey	4630	160 ft. rolls	160
249819	Captain Navy	4646	160 ft. rolls	160
249808	Charcoal Grey	4644	160 ft. rolls	160
249818	Forest Green	4637	160 ft. rolls	160
249829	Heather Beige	4672	160 ft. rolls	160
249811	Jockey Red	4603	160 ft. rolls	160
249817	Linen	4633	160 ft. rolls	160
249827	Medium Blue	4652	160 ft. rolls	160
249820	Navy	4626	160 ft. rolls	160
249810	Pacific Blue	4601	160 ft. rolls	160
249823	Seagrass Green	4645	160 ft. rolls	160
249809	Taupe	4648	160 ft. rolls	160
249814	Terracotta	4622	160 ft. rolls	160
249815	Toast	4628	160 ft. rolls	160

ZipStrip® is a registered trademark of Steel Stitch Corp. Sunbrella® is a registered trademark of Glen Raven, Inc. Tenara® is a registered trademark of W.L. Gore & Associates, Inc.



249836

Steel Stitch™ ZipStrip® – Firesist® Fabric

This fabric covered PVC staple channel trim creates a traditional finish on woven canvas awnings and canopies. Fabric covered ZipStrip is made with Firesist fabrics that completely conceal the PVC material. A durable lockstitch double seam holds the fabric securely in place for years of attractive performance. Custom colors and fabrics are available.

ITEM #	COLOR	COLOR #	PUT UP	STANDARD PACKAGE
249837	Admiral Navy	82010	160 ft. rolls	160
249836	Black	82008	160 ft. rolls	160
249844	Burgundy	82016	160 ft. rolls	160
249845	Crimson	82017	160 ft. rolls	160
249832	Forest Green Tweed	82002	160 ft. rolls	160
249833	Forest Green	82003	160 ft. rolls	160
249831	Regatta	82000	160 ft. rolls	160
249835	Sand	82006	160 ft. rolls	160
249839	Sunburst Yellow	82013	160 ft. rolls	160
249838	Toast Beige	82012	160 ft. rolls	160

ZipStrip® is a registered trademark of Steel Stitch Corp. Firesist® is a registered trademark of Glen Raven, Inc.

Steel Stitch™ ZipStrip® – Firesist® Fabric with Tenara® Thread

This fabric covered PVC staple channel trim creates a traditional finish on woven canvas awnings and canopies. Fabric covered ZipStrip is made with Firesist fabrics that completely conceal the PVC material. A durable lockstitch double seam of Tenara thread holds the fabric securely in place for years of attractive performance. Custom colors and fabrics are available.

ITEM #	COLOR	COLOR #	PUT UP	STANDARD PACKAGE
249857	Admiral Navy	82010	160 ft. rolls	160
249856	Black	82008	160 ft. rolls	160
249865	Crimson	82017	160 ft. rolls	160
249853	Forest Green	82003	160 ft. rolls	160
249851	Regatta	82000	160 ft. rolls	160
249859	Sunburst Yellow	82013	160 ft. rolls	160

ZipStrip® is a registered trademark of Steel Stitch Corp. Firesist® is a registered trademark of Glen Raven, Inc. Tenara® is a registered trademark of W.L. Gore & Associates, Inc.



Steel Stitch™ FlashStrip®

Driven into the back bar to create a secure seal against virtually any building surface. Eliminate the need for labor-intensive caulking by applying a single bead of the sealant to the product prior to installation. Available in Crystal Clear only.



249950

ITEM #	COLOR	COLOR #	PUT UP	STANDARD PACKAGE
249950	Crystal Clear	31	125 ft. rolls	125

Steel Stitch™ is a trademark of Steel Stitch Corporation. FlashStrip® is a registered trademark of Steel Stitch Corporation.



Steel Stitch™ DividerStrip®

Enables joining of awning and canopy modules on the job site.



249981

ITEM #	COLOR	COLOR #	PUT UP	STANDARD PACKAGE
249952	Black	02	200 ft. rolls	200
249981	Crystal Clear	31	200 ft. rolls	200
249968	Dark Green	18	200 ft. rolls	200
249964	Medium Blue	14	200 ft. rolls	200
249951	White	01	200 ft. rolls	200

Steel Stitch™ is a trademark of Steel Stitch Corporation. DividerStrip® is a registered trademark of Steel Stitch Corporation.



250216



250162



228033



250198



228022



250153

Steel Stitch™ Accessories

Steel Stitch branded chisel and divergent point staples work with Bea/Behrens (#250213, #250162), Fasco (#250198) and Apach (#250216) staplers.

ITEM #	STYLE #	DESCRIPTION	FOR USE WITH	PUT UP	SIZE	STANDARD PACKAGE	WEIGHT
250216	LU-9225AC	Apach Stapler with Case			8.8" x 2.3" x 7.8"	1	2.64 lbs.
250162	92/25-553	Bea/Behrens Stapler with Safety				1	
250213	92/25-553	Bea/Behrens Stapler				1	
228035	AS0K151	Danair Hammer O-Ring Kit				1	
228031	T15S	Danair Hammer Replacement Tip, Blue				1	
228033	158	Danair Hammer Replacement Valve				1	
228030	AH15S	Danair Pneumatic Hammer				1	
250198	F21T92-25AST	Fasco Stapler with Safety				1	
250222	805STA12CP	Staples - Steel Stitch Chisel Point Galvanized	BeA Stapler (#250213), BeA Stapler with Safety (#250162), Apach Stapler (#250216)	8400/box	1/2 in.	1 box	
250205	805STA38CP	Staples - Steel Stitch Chisel Point Galvanized	BeA Stapler (#250213), BeA Stapler with Safety (#250162), Apach Stapler (#250216)	5000/box	3/8 in.	1 box	
250158	810STA20	Staples - Steel Stitch Divergent Point Galvanized	BeA Stapler (#250213), BeA Stapler with Safety (#250162), Apach Stapler (#250216)	5000/box	1/2 in.	1 box	
250157	810STA10	Staples - Steel Stitch Divergent Point Galvanized	BeA Stapler (#250213), BeA Stapler with Safety (#250162), Apach Stapler (#250216)	5000/box	3/8 in.	1 box	
250202	810STA85	Staples - Steel Stitch Divergent Point Stainless Steel	BeA Stapler (#250213), BeA Stapler with Safety (#250162), Apach Stapler (#250216)	5000/box		1 box	
250153		Steel Stitch Grinding Disk				25	

Steel Stitch™ is a trademark of Steel Stitch Corporation.

GATORSHIELD® TUBING – GALVANIZED FINISH STEEL

Pipe Schedule 40

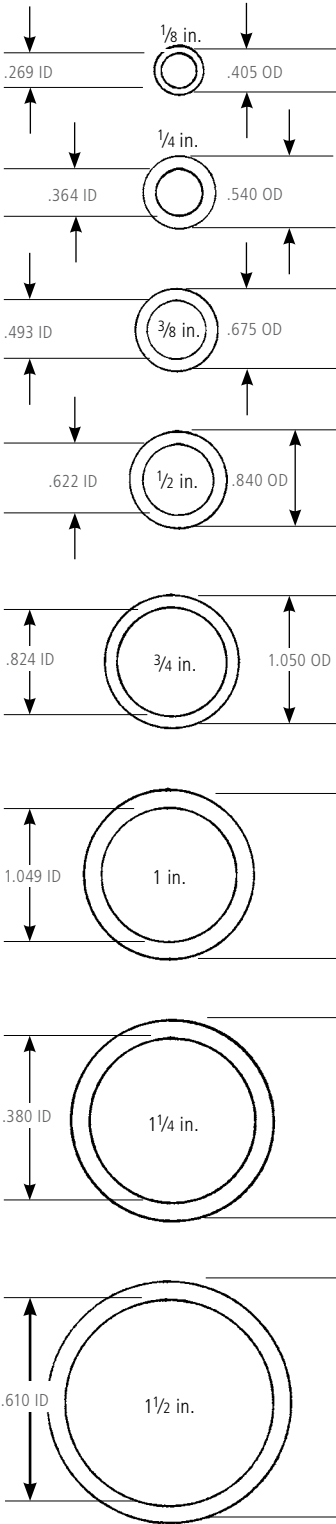

Gatorshield Wall Size

14 GA = .083 18 GA = .049
 15 GA = .072 20 GA = .035
 16 GA = .065

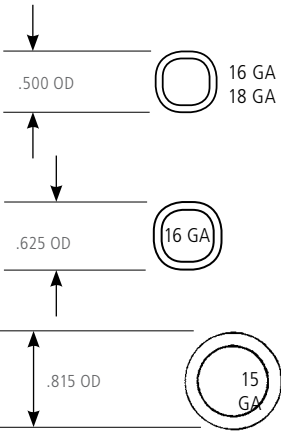

Mechanical Tubing (Numerous wall sizes available)

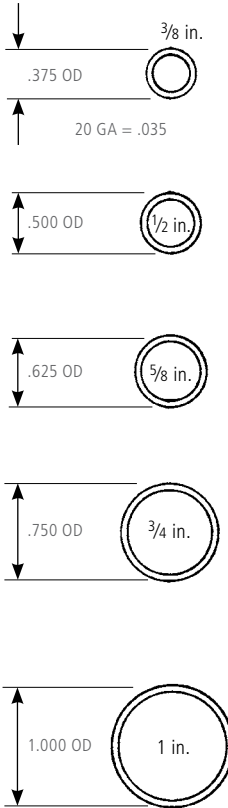

Awning Iron

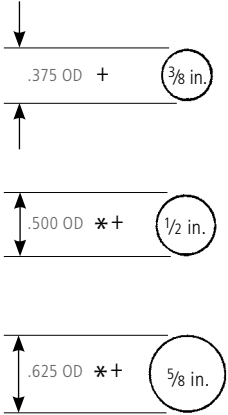

ID = Inside Diameter
 OD = Outside Diameter
 * = Available in Aluminum Headrod
 + = Available in Fiberglass Headrod

Gatorshield® is a registered trademark of Allied Tube & Conduit Corporation.

Gatorshield® – Galvanized Finish Steel Tubing

Gatorshield steel tubing offers triple layer corrosion protection on the exterior surface consisting of zinc, a conversion coating and a clear organic topcoat. The interior is fully covered with a corrosion-resistant zinc coating. Independent tests have proven our steel tubing offers dramatically higher corrosion resistance than other products being marketed for awning framework.

ITEM #	APPROXIMATE WEIGHT PER PIECE	FEET PER BUNDLE	GAUGE	LBS PER FOOT	LENGTH	PIECES PER BUNDLE	SHAPE	SIZE OUTSIDE DIAMETER	STANDARD PACKAGE	WEIGHT PER BUNDLE
276104	54.600 lbs.	240 ft.	14	2.73 lbs.	20 ft.	25	Rectangle	2 in. x 3 in.	12	1365 lbs.
276096	25.400 lbs.	640 ft.	16	1.27 lbs.	20 ft.	32	Rectangle	1 in. x 2 in.	32	813 lbs.
276099	23.230 lbs.	768 ft.	18	0.968 lbs.	24 ft.	32	Rectangle	1 in. x 2 in.	38.4	744 lbs.
276058	16.800 lbs.	1220 ft.	14	0.84 lbs.	20 ft.	61	Round	1.029	61	1025 lbs.
276057	27.328 lbs.	925 ft.	14	1.09 lbs.	25 ft.	37	Round	1.315	37	1011 lbs.
276062	21.800 lbs.	740 ft.	14	1.09 lbs.	20 ft.	37	Round	1.315	37	807 lbs.
276066	28.000 lbs.	740 ft.	14	1.4 lbs.	20 ft.	37	Round	1.660	37	1036 lbs.
276087	48.806 lbs.	888 ft.	14	2.0336 lbs.	24 ft.	37	Round	2-3/8 in.	37	1806 lbs.
276056	11.400 lbs.	1820 ft.	15	0.57 lbs.	20 ft.	91	Round	0.815	91	1037 lbs.
276052	4.800 lbs.	1820 ft.	18	0.24 lbs.	20 ft.	91	Round	0.500	91	437 lbs.
276065	9.960 lbs.	2540 ft.	18	0.498 lbs.	20 ft.	127	Round	1.000	127	1265 lbs.
276108	75.100 lbs.	240 ft.	13	3.76 lbs.	20 ft.	25	Square	3 in.	12	1878 lbs.
276112	100.980 lbs.	320 ft.	13	5.05 lbs.	20 ft.	16	Square	4 in.	8	1616 lbs.
276095	37.786 lbs.	500 ft.	15	1.89 lbs.	20 ft.	25	Square	2 in.	25	945 lbs.
276085	20.680 lbs.	1500 ft.	16	0.83 lbs.	25 ft.	60	Square	1 in.	60	769 lbs.
276084	16.600 lbs.	1200 ft.	16	0.83 lbs.	20 ft.	60	Square	1 in.	60	1241 lbs.
276090	25.400 lbs.	720 ft.	16	1.27 lbs.	20 ft.	36	Square	1-1/2 in.	36	914 lbs.
276080	13.200 lbs.	1600 ft.	16	0.66 lbs.	20 ft.	80	Square	13/16 in.	80	1673 lbs.
276094	34.400 lbs.	500 ft.	16	1.72 lbs.	20 ft.	25	Square	2 in.	25	860 lbs.
276086	12.600 lbs.	1200 ft.	18	0.63 lbs.	20 ft.	60	Square	1 in.	60	561 lbs.
276088	9.200 lbs.	1200 ft.	20	0.46 lbs.	20 ft.	60	Square	1 in.	60	914 lbs.

Gatorshield® is a registered trademark of Allied Tube & Conduit Corporation.

Gatorshield® – Tubing Plug

ITEM #	DESCRIPTION	FOR	INSIDE DIAMETER	PUT UP	SIZE	STANDARD PACKAGE
255419	Square	13/16 in. 16 gauge tubing	11/16 in. x 11/16 in.		13/16 in. x 13/16 in. x 1/2 in.	25
255420	Square	1 in. 16 gauge tubing	7/8 in. x 7/8 in.		1 in. x 1 in. x 1/2 in.	25

Gatorshield® is a registered trademark of Allied Tube & Conduit Corporation.

Gatorshield® – Touch Up Paint



ITEM #	PUT UP	STANDARD PACKAGE
254160	12-oz aerosol can	12

Gatorshield® is a registered trademark of Allied Tube & Conduit Corporation.

54160



Grommet – Aluminum With Plain Washer



233111

ITEM #	STYLE #	HOLE SIZE AFTER SETTING	STANDARD PACKAGE
233111	0	1/4 in.	25 gross
233112	1	9/32 in.	25 gross
233113	2	3/8 in.	25 gross
233114	3	7/16 in.	25 gross
233115	4	1/2 in.	25 gross



Grommet – Brass Eyelet And Washer



233209

ITEM #	STYLE #	DESCRIPTION	STANDARD PACKAGE
233209	2	Grommet with #2J Neck Washer	25 gross



Grommet – Brass Rolled Rim With Spur Washer

These grommets and washers assure maximum strength and resistance to "pulling out." Spur Type setting dies are required for inserting spur grommets.



233311









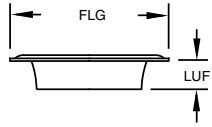

ITEM #	STYLE #	HOLE SIZE AFTER SETTING	STANDARD PACKAGE
233310	0	9/32 in.	1 gross
233311	1	13/32 in.	1 gross
233312	2	7/16 in.	1 gross
233313	3	15/32 in.	1 gross
233314	4	9/16 in.	1 gross
233315	5	5/8 in.	1 gross
233316	6	3/4 in.	1 gross
233317	7	29/32 in.	1 gross
233318	8	1-3/32 in.	1 gross
233320	0	9/32 in.	25 gross
233321	1	13/32 in.	25 gross
233322	2	7/16 in.	25 gross
233323	3	15/32 in.	25 gross
233324	4	9/16 in.	25 gross
233325	5	5/8 in.	25 gross
233326	6	3/4 in.	25 gross
233327	7	29/32 in.	25 gross

Grommet – Brass Rolled Rim With Spur Washer – Black

These grommets and washers assure maximum strength and resistance to "pulling out." Spur Type setting dies are required for inserting spur grommets.

ITEM #	STYLE #	HOLE SIZE AFTER SETTING	STANDARD PACKAGE
233460	0	9/32 in.	1 gross
233461	1	13/32 in.	1 gross
233462	2	7/16 in.	1 gross
233463	3	15/32 in.	1 gross
233464	4	9/16 in.	1 gross
233465	5	5/8 in.	1 gross
233466	6	3/4 in.	1 gross
233467	7	29/32 in.	1 gross
233468	8	1-3/32 in.	1 gross
233470	0	9/32 in.	25 gross
233471	1	13/32 in.	25 gross
233472	2	7/16 in.	25 gross
233473	3	15/32 in.	25 gross
233474	4	9/16 in.	25 gross



<p>No. 00 Hole Size $\frac{3}{16}$ in.</p>  <p>FLG .425 LUF .135 MT .009</p>	<p>No. 0 Hole Size $\frac{1}{4}$ in.</p>  <p>FLG .545 LUF .175 MT .012</p>	
<p>No. 1 Hole Size $\frac{9}{32}$ in.</p>  <p>FLG .687 LUF .185 MT .012</p>	<p>No. 1J Hole Size $\frac{9}{32}$ in.</p>  <p>FLG .680 LUF .263 MT .0126</p>	<p>No. 2 Hole Size $\frac{3}{8}$ in.</p>  <p>FLG .815 LUF .215 MT .013</p>
<p>No. 2J Hole Size $\frac{3}{8}$ in.</p>  <p>FLG .840 LUF .260 MT .016</p>	<p>No. 3 Hole Size $\frac{7}{16}$ in.</p>  <p>FLG .970 LUF .295 MT .014</p>	<p>No. 4 Hole Size $\frac{1}{2}$ in.</p>  <p>FLG 1.050 LUF .374 MT .016</p>
<p>No. 5 Hole Size $\frac{5}{8}$ in.</p>  <p>FLG 1.220 LUF .330 MT .016</p>	<p>No. 6 Hole Size $\frac{13}{16}$ in.</p>  <p>FLG 1.750 LUF .232 MT .020</p>	

Grommet – Brass With Plain Washer

Made of heavy-gauge brass, assuring maximum strength and resistance against “pulling out.” Can be used interchangeably with plain or teeth washers. Meets Government Specifications, MIL-G-16491F, MS-20230, NASM-16491 and NASM-20230.

ITEM #	STYLE #	HOLE SIZE AFTER SETTING	STANDARD PACKAGE
233210	00	3/16 in.	1 gross
233211	0	1/4 in.	1 gross
233212	1	9/32 in.	1 gross
233213	1J	9/32 in.	1 gross
233214	2	3/8 in.	1 gross
233215	2J	3/8 in.	1 gross
233216	3	7/16 in.	1 gross
233217	4	1/2 in.	1 gross
233218	5	5/8 in.	1 gross
233219	6	13/16 in.	1 gross
233220	00	3/16 in.	25 gross
233221	0	1/4 in.	25 gross
233222	1	9/32 in.	25 gross
233223	1J	9/32 in.	25 gross
233224	2	3/8 in.	25 gross
233225	2J	3/8 in.	25 gross
233226	3	7/16 in.	25 gross
233227	4	1/2 in.	25 gross
233228	5	5/8 in.	25 gross
233229	6	13/16 in.	25 gross



233374

Grommet – Brass With Plain Washer – Black

Made of heavy-gauge brass, assuring maximum strength and resistance against “pulling out.” Can be used interchangeably with plain or teeth washers. Meets Government Specifications, MIL-G-16491F, MS-20230, NASM-16491 and NASM-20230.

ITEM #	STYLE #	HOLE SIZE AFTER SETTING	STANDARD PACKAGE
233360	00	3/16 in.	1 gross
233361	0	1/4 in.	1 gross
233362	1	9/32 in.	1 gross
233364	2	3/8 in.	1 gross
233366	3	7/16 in.	1 gross
233367	4	1/2 in.	1 gross
233370	00	3/16 in.	25 gross
233371	0	1/4 in.	25 gross
233372	1	9/32 in.	25 gross
233374	2	3/8 in.	25 gross
233376	3	7/16 in.	25 gross
233377	4	1/2 in.	25 gross
233378	5	5/8 in.	25 gross
233379	6	13/16 in.	25 gross

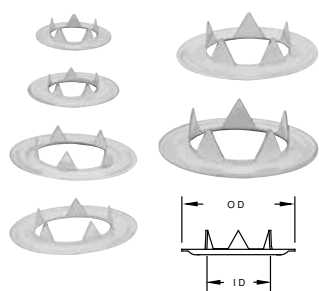

Grommet – Brass With Tooth Washer

ITEM #	STYLE #	HOLE SIZE AFTER SETTING	STANDARD PACKAGE
233230	0	1/4 in.	1 gross
233231	1	9/32 in.	1 gross
233233	2	3/8 in.	1 gross
233235	3	7/16 in.	1 gross
233236	4	1/2 in.	1 gross
233237	5	5/8 in.	1 gross
233240	0	1/4 in.	25 gross
233241	1	9/32 in.	25 gross
233243	2	3/8 in.	25 gross
233245	3	7/16 in.	25 gross
233246	4	1/2 in.	25 gross
233247	5	5/8 in.	25 gross



Grommet – Brass With Tooth Washer – Black

ITEM #	STYLE #	HOLE SIZE AFTER SETTING	STANDARD PACKAGE
233380	0	1/4 in.	1 gross
233390	0	1/4 in.	25 gross
233391	1	9/32 in.	25 gross
233393	2	3/8 in.	25 gross
233395	3	7/16 in.	25 gross



Grommet – Nickel-Plated Brass With Plain Washer

ITEM #	STYLE #	HOLE SIZE AFTER SETTING	STANDARD PACKAGE
233520	00	3/16 in.	1 gross
233521	0	1/4 in.	1 gross
233522	1	9/32 in.	1 gross
233524	2	3/8 in.	1 gross
233526	3	7/16 in.	1 gross
233527	4	1/2 in.	1 gross
233528	5	5/8 in.	1 gross
233529	6	13/16 in.	1 gross
233530	00	3/16 in.	25 gross
233531	0	1/4 in.	25 gross
233532	1	9/32 in.	25 gross
233534	2	3/8 in.	25 gross
233536	3	7/16 in.	25 gross
233537	4	1/2 in.	25 gross
233538	5	5/8 in.	25 gross



Grommet – Nickel-Plated With Tooth Washer



233547

ITEM #	STYLE #	HOLE SIZE AFTER SETTING	STANDARD PACKAGE
233540	0	1/4 in.	1 gross
233541	1	9/32 in.	1 gross
233542	2	3/8 in.	1 gross
233543	3	7/16 in.	1 gross
233546	4	1/2 in.	1 gross
233547	5	5/8 in.	1 gross
233552	1	9/32 in.	25 gross
233553	2	3/8 in.	25 gross



Grommet – Nickel-Plated Rolled Rim Brass With Spur Washer



233627

ITEM #	STYLE #	HOLE SIZE AFTER SETTING	STANDARD PACKAGE
233620	0	9/32 in.	1 gross
233621	1	13/32 in.	1 gross
233622	2	7/16 in.	1 gross
233623	3	15/32 in.	1 gross
233624	4	9/16 in.	1 gross
233625	5	5/8 in.	1 gross
233626	6	3/4 in.	1 gross
233627	7	29/32 in.	1 gross
233628	8	1-3/32 in.	1 gross
233630	0	9/32 in.	25 gross
233631	1	13/32 in.	25 gross
233632	2	7/16 in.	25 gross
233633	3	15/32 in.	25 gross
233634	4	9/16 in.	25 gross

Grommet – Self-Piercing

Will pierce most fabrics without pre-punching a hole, while setting the grommet and washer in the same action.

ITEM #	STYLE #	HOLE SIZE AFTER SETTING	MATERIAL	STANDARD PACKAGE
233032	2	3/8 in.	Brass	500

Grommet – Self-Piercing With Plain Washer

Will pierce most fabrics without pre-punching a hole, while setting the grommet and washer in the same action.

ITEM #	STYLE #	FINISH	HOLE SIZE AFTER SETTING	MATERIAL	STANDARD PACKAGE
233020	0		1/4 in.	Brass	500
233021	1		5/16 in.	Brass	500
233022	2		3/8 in.	Brass	500
233019	2	Nickel Plated	3/8 in.	Brass	500
235414	2		3/8 in.	Stainless Steel	500
233023	3		7/16 in.	Brass	500
233017	3	Nickel Plated	7/16 in.	Brass	500
235413	GRMWSH2305S		5/16 in.	Stainless Steel	500

Grommet – Self-Piercing Rolled Rim With Spur Washer

Will pierce most fabrics without pre-punching a hole, while setting the grommet and washer in the same action.

ITEM #	STYLE #	FINISH	HOLE SIZE AFTER SETTING	MATERIAL	STANDARD PACKAGE
233050	0		1/4 in.	Stainless Steel	100
233024	1	Nickel Plated	3/8 in.	Brass	500
233051	1		5/16 in.	Stainless Steel	100
233025	2	Nickel Plated	7/16 in.	Brass	250
233052	2		3/8 in.	Stainless Steel	100
233053	3		7/16 in.	Stainless Steel	100
233054	4		1/2 in.	Stainless Steel	100
233055	5		5/8 in.	Stainless Steel	100

Grommet – Sharpened Edge With Small Tooth Locking Channel Washer

Will pierce most fabrics without pre-punching a hole, while setting the grommet and washer in the same action.

ITEM #	STYLE #	FINISH	HOLE SIZE AFTER SETTING	MATERIAL	STANDARD PACKAGE
233973	1	Lacquer	5/16 in.	Brass	500
233071	1	Nickel Plated	5/16 in.	Brass	500
233566	2	Nickel Plated	3/8 in.	Brass	500
233975	3	Lacquer	7/16 in.	Brass	100
233567	3	Nickel Plated	7/16 in.	Brass	100

Grommet – Special Brass And Washers

ITEM #	STYLE #	DESCRIPTION	FINISH	STANDARD PACKAGE
233186	2	Grommet with #2 Neck Washer	Brass	25 gross
233519	0	Grommet with A-1197 Washer	Nickel Plated	25 gross
233589	2	Grommet with A-3630 Washer	Nickel Plated	25 gross
233183	1	Grommet with A1340 Neck Washer	Black	25 gross
233188	1	Grommet with A1340 Neck Washer	Brass	25 gross
233184	1	Grommet with A1340 Neck Washer	Nickel	25 gross
233185	2	Grommet with Spur Washer	Paraffin Coated Brass	25 gross

Grommet – Scovill Grommets With Washers

ITEM #	STYLE #	DESCRIPTION	FINISH	HOLE SIZE AFTER SETTING	MATERIAL	STANDARD PACKAGE
233705	1	A1340 Neck Washer	Nickel Plated	9/32 in.	Brass	25 gross
233651	2	A3630 Washer			Brass	25 gross
233707	0	Plain Washer		1/4 in.	Brass	25 gross
233708	1	Plain Washer		9/32 in.	Brass	25 gross
233709	2	Plain Washer		3/8 in.	Brass	25 gross
233728	2	Plain Washer	Nickel Plated	3/8 in.	Brass	25 gross
233710	3	Plain Washer		7/16 in.	Brass	25 gross
233729	3	Plain Washer	Nickel Plated	7/16 in.	Brass	25 gross
233719	4	Plain Washer	Black	1/2 in.	Brass	25 gross
233711	4	Plain Washer		1/2 in.	Brass	25 gross
233712	2	Tooth Washer		3/8 in.	Brass	25 gross
233720	2	Tooth Washer	Black	3/8 in.	Brass	25 gross
233713	3	Tooth Washer		7/16 in.	Brass	25 gross
233714	4	Tooth Washer		1/2 in.	Brass	25 gross

Scovill® is a registered trademark of GSG Fasteners, LLC

Grommet – Scovill Rolled Rim Grommets With Spur Washers

ITEM #	STYLE #	FINISH	HOLE SIZE AFTER SETTING	MATERIAL	STANDARD PACKAGE
233636	0		9/32 in.	Brass	25 gross
233637	1		13/32 in.	Brass	25 gross
233638	2		7/16 in.	Brass	25 gross
233639	3		15/32 in.	Brass	25 gross
233640	4		9/16 in.	Brass	25 gross
233722	0	Black	9/32 in.	Brass	25 gross
233723	1	Black	13/32 in.	Brass	25 gross
233724	2	Black	7/16 in.	Brass	25 gross
233725	3	Black	15/32 in.	Brass	25 gross
233726	4	Black	9/16 in.	Brass	25 gross

Scovill® is a registered trademark of GSG Fasteners, LLC



E-Z Lace Supreme®

E-Z Lace Supreme eliminates the need to insert grommets. A 1 inch re-enforced side hole size makes lacing that much easier and quicker, while the 3 inch center spacing of the holes greatly increases manufacturing design flexibility. E-Z Lace Supreme also has a specialized and durable finish that resists mildew and ultraviolet rays, significantly increasing long-term strength and durability.

ITEM #	STYLE #	COLOR	PUT UP	WIDTH
502108	6608	Black	50 yd.	2-1/8 in.
502110	6631	Burgundy	50 yd.	2-1/8 in.
502109	6630	Cadet Grey	50 yd.	2-1/8 in.
502111	6637	Forest Green	50 yd.	2-1/8 in.
502112	6604	Natural	50 yd.	2-1/8 in.
502107	6601	Pacific Blue	50 yd.	2-1/8 in.

E-Z Lace Supreme® is a trademark of Offray Specialty Narrow Fabrics.



207665

Buckles – “Push-Button”

ITEM #	STYLE #	FINISH	STANDARD PACKAGE	WEBBING SIZE
207671	6105	Black enamel	100	1 in.
207668	6105	Cadmium plated	100	1 in.
207724	6105	Nickel plated	100	1 in.
207722	6105	Nickel plated	100	1-1/2 in.
207667	6105	Nickel plated	100	3/4 in.
207723	6105	Stainless Steel	100	1 in.
207721	6105	Stainless steel	100	1-1/2 in.
207665	3105	Zinc plated	500	1 in.



207652

Buckles – For Nylon Or Polyester Webbing

A 1 inch non-slip buckle developed to provide a positive hold on very smooth nylon or polyester webbing when webbing is threaded through the buckle.

ITEM #	STYLE #	FINISH	STANDARD PACKAGE	WEBBING SIZE
207652	1020	Nickel plated	100	1 in.
207680	4042	Nickel plated	100	1 in.



207680



207558

Buckles – Single Bar

For 1 inch webbing. Sheet brass, black finish. Meets Mil-B-543 Type 1, Style 2, Class 1.

ITEM #	STYLE #	STANDARD PACKAGE	WEBBING SIZE
207558	146	100	1 in.



207650



207512

Buckles – Tongueless

Dependable and sturdy buckles with a firm locking toothed slide. Made of the finest grade zinc-plated stamped steel. When ordering, specify style # and size.

ITEM #	STYLE #	FINISH	STANDARD PACKAGE	TYPE	WEBBING SIZE
207650	01055	Cadmium plated	100	Type 1, 2, 3	1 in.
207512	2690	Cadmium plated	50	Type 1, 2, 3	1-1/2 in.
207516	5270	Cadmium plated	50	Type 1, 2, 3	2 in.
207517	5270	Nickel plated	100	Type 1, 2, 3	2 in.
207508	635	Zinc plated	200	Type 1	1 in.



207516



207508



260441

Clip And Dee – Nickel Plated

ITEM #	STYLE #	INSIDE DIMENSION WIDTH	SIZE	SIZE HOLE	STANDARD PACKAGE
260441	1954	3/4 in.	1-3/8 in.	0.201 in.	1000



213820

Clip And Dee – Stainless

ITEM #	STYLE #	INSIDE DIMENSION WIDTH	LENGTH	SIZE HOLE	STANDARD PACKAGE
213820	1954	3/4 in.	1-3/8 in.	0.201 in.	1000



249216

Footman Loop

Made of zinc-plated steel. Used to secure web straps on car top carriers, boat covers, camping trailers and other specialty products. Undrilled Footman Loops for welding can also be supplied.

ITEM #	STYLE #	DIAMETER HOLE	SIZE	STANDARD PACKAGE	WEBBING SIZE
249208	118-BX100-25	7/32 in.	2-5/8 in.	100	1 in.
249203	118-BX1000-25	7/32 in.	2-5/8 in.	1000	1 in.
249214	524	7/32 in.	3-1/8 in.	100	1-1/2 in.
249218	138	1/4 in.	2-3/4 in.	100	1-1/4 in.
249216	218	1/4 in.	3-5/8 in.	100	2 in.



295565

Webbing Loop

Made of nickel-plated steel.

ITEM #	STYLE #	SIZE	STANDARD PACKAGE	TYPE
295560	4950	1 in. x 7/16 in.	100	Unwelded
295565	69900	2 in. x 7/16 in.	100	Unwelded



275703

Triangle Ring

ITEM #	FINISH	MATERIAL	SIZE	STANDARD PACKAGE
275703	Nickel Plated	Steel	1-1/2 in. x 1-1/2 in. x 1-1/2 in.	100



260507

Dee Ring – Non-Welded – Zinc Plated

Made of steel wire, with a zinc plating. Non-welded.

ITEM #	STYLE #	INSIDE DIMENSION HEIGHT	INSIDE DIMENSION WIDTH	STANDARD PACKAGE	WIRE DIAMETER
260507	563	5/8 in.	3/4 in.	500	0.135 in.
260508	563	7/8 in.	1 in.	200	0.135 in.
260512	563	1-3/16 in.	1-1/2 in.	200	0.148 in.



260527

Dee Ring – Welded – Zinc Plated

Made of heavy steel wire, with a zinc plating. Welded.

ITEM #	STYLE #	INSIDE DIMENSION HEIGHT	INSIDE DIMENSION WIDTH	STANDARD PACKAGE	WIRE DIAMETER
260527	3250	3/4 in.	7/8 in.	100	0.207 in.
260528	3250	7/8 in.	1 in.	100	0.207 in.
260529	3250	1 in.	1-1/8 in.	100	0.207 in.
260530	3250	1-1/8 in.	1-1/4 in.	100	0.243 in.
260532	3250	1-5/16 in.	1-1/2 in.	50	0.253 in.
260534	3250	1-1/2 in.	1-3/4 in.	50	0.262 in.
260536	3250	1-5/8 in.	2 in.	50	0.262 in.



260500

Ring – Dee Nickel Plated

ITEM #	STYLE #	DESCRIPTION	FINISH	INSIDE DIMENSION HEIGHT	INSIDE DIMENSION WIDTH	MATERIAL	STANDARD PACKAGE	WIRE DIAMETER
260500	3250	Welded	Nickel Plated	1-3/5 in.	2 in.	Steel	500	0.260 in.
260502	563	Non-Welded	Nickel Plated	7/8 in.	1 in.	Steel	200	0.135 in.
260503	563	Non-Welded	Nickel Plated	5/8 in.	3/4 in.	Steel	500	0.135 in.
260511	45204	Non-Welded	Nickel Plated	8/9 in.	1 in.	Zinc Die-Cast	1000	0.154 in.



260502



260511



267320

Spring – Trampoline

ITEM #	LENGTH	STANDARD PACKAGE
267320	8 in.	100



295531

Webbing – 3 Bar Slide

Made of stamped steel, nickel plated. Used for garments, parkas, outerwear, equestrian equipment, horse blankets.



295537

ITEM #	STYLE #	SIZE	STANDARD PACKAGE
295531	02300	1 in.	500
295532	02300	1-1/2 in.	500
295534	02300	2 in.	500
295537	03300	2 in.	200



274908

Webbing – Tip For Types I And II Webbing

Flat type. Nickel plated steel.

ITEM #	STYLE #	SIZE	STANDARD PACKAGE
274908	1	1 in.	1000



275012

Webbing – Tip For Types I, II And III Webbing

Ball type. Brass with black finish. Meets Government Specifications MIL-C-496.

ITEM #	STYLE #	SIZE	STANDARD PACKAGE
275008	149	1 in.	1000
275012	149	1-1/2 in.	25



207701

ACW Side Release Buckles



207697

ITEM #	STYLE #	DESCRIPTION	COLOR	MATERIAL	STANDARD PACKAGE	WEBBING SIZE
207701	91514 BSR	Side Release Buckle	Black	Acetal	100	1 in.
207564	91760	Side Release Buckle	Black	Acetal	100	1-1/2 in.
207697	91526 BSR-DA	Side Release Double Adjust Buckle	Black	Acetal	100	1 in.



585060

Fastex® Side Release Buckle

Can be used on backpacks, camera bags, and many other fastening applications.

ITEM #	DESCRIPTION	COLOR	MATERIAL	STANDARD PACKAGE	WEBBING SIZE
585030		Black	Delrin®	100	1 in.
585032	Body Only	Black	Delrin®	1	1 in.
585070		Black	Nexcel	100	1-1/2 in.
585060		Black	Delrin®	100	1-1/2 in.
585075		Black	Delrin®	100	2 in.
585015		Black	Delrin®	100	3/4 in.
585031		White	Delrin®	100	1 in.
585016		White	Delrin®	100	3/4 in.

Fastex® is a registered trademark of ITW. Delrin® is a registered trademark of E.I. DuPont de Nemours and Company, Inc.



585215

Fastex® Ladderloc™

Can be used on backpacks, camera bags, and many other fastening applications.

ITEM #	STYLE #	COLOR	MATERIAL	STANDARD PACKAGE	WEBBING SIZE
585215	154-0075	Black	Delrin®	100	3/4 in.
585270	104-2200	Black	Delrin®	100	2 in.
585283	154-3100-5614	Black	Delrin®	1000	1 in.

Fastex® is a registered trademark of ITW. Ladderloc™ is a trademark of ITW. Delrin® is a registered trademark of E.I. DuPont de Nemours and Company, Inc.

ACW Cam Buckles

ITEM #	STYLE #	COLOR	MATERIAL	STANDARD PACKAGE	WEBBING SIZE
207720	91390 CB	Black	Acetal	100	1 in.



586430

Fastex® Cam Buckle

This versatile buckle works with a camming action directly against webbing. It provides easy adjustment and high security at the same time and is suitable for a wide range of webbing applications. One-handed quick release.

ITEM #	COLOR	COLOR #	MATERIAL	STANDARD PACKAGE	WEBBING SIZE
586430	Black	525	Delrin®	100	1 in.

Fastex® is a registered trademark of ITW. Delrin® is a registered trademark of E.I. DuPont de Nemours and Company, Inc.

YKK® Wheel Locks

All plastic hardware.

ITEM #	STYLE #	DESCRIPTION	COLOR	STANDARD PACKAGE	WEBBING SIZE
585585	93838	Wheel Lock	Black	100	1 in.

YKK® is a registered trademark of YKK Corporation.



586110

Fastex® Barreloc

Limitless applications include locking sleeping bag and parka hood draw strings. Can be used with either one or two cords.

ITEM #	COLOR	MATERIAL	ROPE SIZE	STANDARD PACKAGE
586110	Black	Delrin®	3/16 in.	100

Fastex® is a registered trademark of ITW. Delrin® is a registered trademark of E.I. DuPont de Nemours and Company, Inc.



587300

Fastex® Sewable Grommet

Molded from a toughened nylon, the Sewable Grommet can be sewn directly to fabric or webbing. It will withstand heavy load and stress factors, yet always return to its original shape. It is unaffected by weather and will not snap or pull rope or cord running through it. Unaffected by ultraviolet degradation. Radio frequency bondable.

ITEM #	STYLE #	MATERIAL	STANDARD PACKAGE
587300	406-0000	Toughened Nylon	500

Fastex® is a registered trademark of ITW.



586578

Fastex® Ellipse Cordloc

Provides an option for a lanyard tie down to assist in hand adjustments.

ITEM #	COLOR	MATERIAL	ROPE SIZE	STANDARD PACKAGE
586578	Black	Delrin®	1/4 in.	1000

Fastex® is a registered trademark of ITW. Delrin® is a registered trademark of E.I. DuPont de Nemours and Company, Inc.



586920

Fastex® Shock Cord Hook

These shock cord fasteners will not mar or scratch anything they touch. The entire unit is molded, which eliminates the necessity of using a metal crimp ring. They are also rust and corrosion proof. Operates under all weather conditions. Not affected by salt water.

ITEM #	STYLE #	COLOR	CORD SIZE	MATERIAL	STANDARD PACKAGE
586920	605-0250-5614	Black	1/4 in.	Delrin®	100
586930	605-0375	Black	5/16 in.	Delrin®	100

Fastex® is a registered trademark of ITW. Delrin® is a registered trademark of E.I. DuPont de Nemours and Company, Inc.



585630

Fastex® D-Ring

These D-rings are perfect whenever a sturdy attachment point is required. Unlike metal D-rings, they won't rust or corrode. One inch D-ring available in double-bar version, which prevents D-ring from slipping or rotating within its webbing retainer.

ITEM #	COLOR	MATERIAL	STANDARD PACKAGE	WEBBING SIZE
585630	Black	Delrin®	100	1 in.
585660	Black	Delrin®	100	1-1/2 in.
585675	Black	Delrin®	100	2 in.

Fastex® is a registered trademark of ITW. Delrin® is a registered trademark of E.I. DuPont de Nemours and Company, Inc.



585975

Fastex® Triglide™ 3 Bar Slide

For sporting, recreational, luggage, medical, apparel and juvenile products. Extremely popular in the floatation and backpacking industries, these buckles can be used wherever webbing closures are needed. Useful in just about any application in which a variable length strap assembly is required.

ITEM #	STYLE #	COLOR	MATERIAL	STANDARD PACKAGE	WEBBING SIZE
585930	105-0100	Black	Delrin®	100	1 in.
585960	105-0150	Black	Delrin®	100	1-1/2 in.
585975	105-0200	Black	Delrin®	100	2 in.

Fastex® is a registered trademark of ITW. Triglide™ is a trademark of ITW. Delrin® is a registered trademark of E.I. DuPont de Nemours and Company, Inc.



585775

Fastex® Looploc

Ideal for holding straps or webbing where no adjustment is needed.

ITEM #	STYLE #	COLOR	MATERIAL	STANDARD PACKAGE	WEBBING SIZE
585715		Black	Delrin®	100	1 in.
585760		Black	Delrin®	100	1-1/2 in.
585775	111-0200	Black	Delrin®	100	2 in.

Fastex® is a registered trademark of ITW. Delrin® is a registered trademark of E.I. DuPont de Nemours and Company, Inc.



207540

YKK® Fasteners

All plastic hardware.



207545



586089

ITEM #	STYLE #	DESCRIPTION	COLOR	STANDARD PACKAGE	WEBBING SIZE
207540	LBS1	Easy Release Buckle	Black	100	1"
207543	LBRU1	Heavy Duty Quick Release Buckle	Black	1000	1"
207545	LBRU1.5	Heavy Duty Quick Release Buckle	Black	1000	1-1/2"
586089	LC05SHD		Black	1500	

YKK® is a registered trademark of YKK Corporation.



585310

Snaphook – Interlocking Snaphook

Applications are similar to those of the side release buckle. However, the "tooth" design increases the overall strength.

ITEM #	STYLE #	COLOR	MATERIAL	STANDARD PACKAGE
585310	106-1000	Black	Delrin®	100

Delrin® is a registered trademark of E.I. DuPont de Nemours and Company, Inc.



585430

Snaphook – Retainer

Other styles and colors available on special order.

ITEM #	STYLE #	COLOR	MATERIAL	SIZE	STANDARD PACKAGE
585430	108-0100	Black	Delrin®	1 in.	100
585460	108-0150	Black	Delrin®	1-1/2 in.	100
585475	108-0200-5614	Black	Delrin®	2 in.	100

Delrin® is a registered trademark of E.I. Dupont de Nemours and Company, Inc.



585300

Snaphook – Standard Snaphook

Used most often for detachable shoulder straps.

ITEM #	STYLE #	COLOR	MATERIAL	STANDARD PACKAGE
585300	106-0000	Black	Delrin®	100

Delrin® is a registered trademark of E.I. Dupont de Nemours and Company, Inc.



DOT® Baby Durable™

An intermediate size snap fastener. Baby Durable provides firm snap action and strong holding power without being visually prominent on the end item.

ITEM #	STYLE #	DESCRIPTION	FINISH	SIZE	STANDARD PACKAGE
230991	94-X2-12108-2B	Cap	Black Oxide	3/16 in.	1000
230854	94-XB-12105-2B	Cap	Black Oxide		1000
230997	94-BS-12402-2C	Post	Black Oxide	3/16 in.	1000
230993	94-XB-12205-2C	Socket	Black Oxide		1000
230995	94-BS-12302-2C	Stud	Black Oxide		1000
230998	94-BS-12303-2C	Stud	Black Oxide		1000
230717	94-XB-12105-4A	Cap	Nickel Plated		100
230794	94-BS-12402-1A	Post	Nickel Plated	3/16 in.	100
230795	94-BS-12404-2A	Post	Nickel Plated	1/4 in.	1000
230792	94-XB-12205-4A	Socket	Nickel Plated		100
230959	94-BS-12303-2A	Stud	Nickel Plated		1000

DOT® Common Sense® / Curtain Fasteners

Curtain fasteners are available in brass lacquer, nickel or black finish. All studs have rust-resistant brass springs. Sold in full package lots of 100 and 1000 pieces.

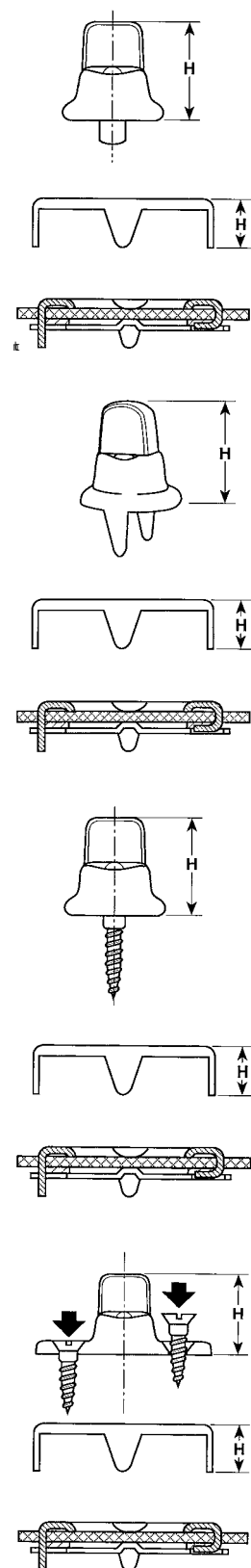

ITEM #	STYLE #	DESCRIPTION	FINISH	SIZE	STANDARD PACKAGE	TOOLS PART #
230509	91-PS-78511-49	Washer			100	
230378	91-BS-78502-2C	Back Plate	Black Oxide		1000	
230385	91-BS-78404-2G	Eyelet (Long)	Black Oxide		1000	
230580	91-BS-78403-1G	Eyelet	Black Oxide		100	C4-450 (#216045)
230380	91-BS-78403-2G	Eyelet	Black Oxide		1000	C4-450 (#216045)
230587	91-XB-78332-1G	Turn Button Double Prong	Black Oxide		100	171 (#275575)
230386	91-XB-78322-2G	Turn Button Two Screw Holes	Black Oxide		1000	
230377	91-XB-78317-2G	Turn Button	Black Oxide		1000	
230581	91-BS-78505-1C	Washer	Black Oxide		100	
230381	91-BS-78505-2C	Washer	Black Oxide		1000	
230207	91-BS-78507-2D	Back Plate	Gilt		1000	171 (#275575)
230403	91-BS-78403-1E	Eyelet	Gilt		100	C4-450 (#216045)
230203	91-BS-78403-2E	Eyelet	Gilt		1000	C4-450 (#216045)
230423	91-XB-78323-1E	Turn Button Double Height Two Screw Holes	Gilt		100	
230223	91-XB-78323-2E	Turn Button Double Height Two Screw Holes	Gilt		1000	
230234	91-XB-78333-2E	Turn Button Double Prong Double Height	Gilt		1000	171 (#275575)
230426	91-XB-783247-1E	Turn Button Screw Stud	Gilt	5/8 in.	100	89-9908 (#275584)
230226	91-XB-783247-2E	Turn Button Screw Stud	Gilt	5/8 in.	1000	89-9908 (#275584)
230422	91-XB-78322-1E	Turn Button Two Screw Holes	Gilt		100	
230405	91-BS-78505-1D	Washer	Gilt		100	
230205	91-BS-78505-2D	Washer	Gilt		1000	
230504	91-BS-78502-1A	Back Plate	Nickel Plated		100	
230307	91-BS-78507-2A	Back Plate	Nickel Plated		1000	171 (#275575)
230507	91-BS-78507-4A	Back Plate	Nickel Plated		100	171 (#275575)
230534	91-BS-78404-4A	Eyelet (Long)	Nickel Plated		100	
230303	91-BS-78403-2A	Eyelet	Nickel Plated		1000	C4-450 (#216045)
230503	91-BS-78403-4A	Eyelet	Nickel Plated		100	C4-450 (#216045)
230527	91-XB-783257-1A	Turn Button Double Height Screw Stud	Nickel Plated	5/8 in.	100	89-9908 (#275584)
230327	91-XB-783257-2A	Turn Button Double Height Screw Stud	Nickel Plated	5/8 in.	1000	89-9908 (#275584)
230323	91-XB-78323-2A	Turn Button Double Height Two Screw Holes	Nickel Plated		1000	
230523	91-XB-78323-4A	Turn Button Double Height Two Screw Holes	Nickel Plated		100	
230533	91-XB-78333-1A	Turn Button Double Prong Double Height	Nickel Plated		100	171 (#275575)
230332	91-XB-78332-2A	Turn Button Double Prong	Nickel Plated		1000	171 (#275575)
230532	91-XB-78332-4A	Turn Button Double Prong	Nickel Plated		100	171 (#275575)
230520	91-X8-783247-1A	Turn Button Screw Stud	Nickel Plated	5/8 in.	100	89-9908 (#275584)
230228	91-X8-783247-2A	Turn Button Screw Stud	Nickel Plated	5/8 in.	1000	89-9908 (#275584)
230326	91-XB-783247-2A	Turn Button Screw Stud	Nickel Plated	5/8 in.	1000	89-9908 (#275584)
230526	91-XB-783247-4A	Turn Button Screw Stud	Nickel Plated	5/8 in.	100	89-9908 (#275584)
230220	91-XX-783157-2A	Turn Button Screw Stud	Nickel Plated	5/8 in.	1000	
230500	91-XX-783157-4A	Turn Button Screw Stud	Nickel Plated	5/8 in.	100	89-9908 (#275584)
230322	91-XB-78322-2A	Turn Button Two Screw Holes	Nickel Plated		1000	
230522	91-XB-78322-4A	Turn Button Two Screw Holes	Nickel Plated		100	
230549	91-XB-78317-4A	Turn Button	Nickel Plated		100	
230305	91-BS-78505-2A	Washer	Nickel Plated		1000	
230505	91-BS-78505-4A	Washer	Nickel Plated		100	
230311	91-BS-78510-2A	Washer	Nickel Plated		1000	
230508	91-BS-78510-4A	Washer	Nickel Plated		100	

DOT® and Common Sense® are registered trademarks of Scovill, Inc. Durable™ is a trademark of Scovill.



230932

DOT® Durable™ Blind Rivet Stud

This component will provide the installer with a convenient method for securing a stud on hard surfaces such as steel, aluminum, tubing and panels.

Blind Rivet Studs are set in the same manner as typical pop rivets and eliminate the need for threading a stud into a pre-drilled hole or using a machine screw and nut combination. Used with the X2-10128 Button and XB-10224 Socket or similar combinations.

ITEM #	STYLE #	DESCRIPTION	FINISH	STANDARD PACKAGE
230772	93-X8-10314-1A	Blind Rivet Stud	Nickel Plated/Stainless Steel Mandrel	100
230932	93-X8-10314-2A	Blind Rivet Stud	Nickel Plated/Stainless Steel Mandrel	1000
230774	93-X8-10319-1A	Blind Rivet Stud	Nickel Plated/Stainless Steel Mandrel	100

DOT® is a registered trademark of Scovill, Inc. Durable™ is a trademark of Scovill, Inc.



229625

DOT® Durable™ Enamel

These ultraviolet stabilized enamel painted buttons are in popular demand. The generous color selection is designed to match or compliment a wide variety of today's most popular marine fabrics. Available in packs of 100 and 1000.

ITEM #	STYLE #	COLOR	STANDARD PACKAGE
229684	93-X8-10128-9024-1V	Bahama Berry	100
229683	93-X8-10128-9023-1V	Banana Split	100
229601	93-X2-10128-1339-1V	Black	100
229901	93-X2-10128-1339-2V	Black	1000
229650	93-X8-10128-1339-1V	Black	100
229669	93-X8-10128-9009-1V	Blue Marlin	100
229675	93-X8-10128-9015-1V	Burnt Sugar	100
229617	93-X2-10128-2595-1V	Butternut Beige	100
229625	93-X2-10128-9000-1V	Cadet Grey	100
229660	93-X8-10128-9000-1V	Cadet Grey	100
229623	93-X2-10128-9002-1V	Captain Navy	100
229662	93-X8-10128-9002-1V	Captain Navy	100
229620	93-X2-10128-1473-1V	Dark Green	100
229651	93-X8-10128-1473-1V	Dark Green	100
229900	93-X2-10128-1534-2V	Dull Black	1000
229653	93-X8-10128-1534-1V	Dull Black	100
229600	93-X2-10128-1534-1V	Dull Black	100
229655	93-X8-10128-2234-1V	Foliage Green	100

ITEM #	STYLE #	COLOR	STANDARD PACKAGE
229632	93-X2-10128-9004-1V	Heather Beige	100
229664	93-X8-10128-9004-1V	Heather Beige	100
229604	93-X2-10128-1487-1V	Lindy	100
229690	93-X8-10128-9030-1V	Logo Red	100
229629	93-X2-10128-9030-1V	Logo Red	100
229611	93-X2-10128-1290-1V	Medium Turquoise	100
229615	93-X2-10128-2104-1V	Mulberry	100
229622	93-X2-10128-9012-1V	Ranch Blue	100
229672	93-X8-10128-9012-1V	Ranch Blue	100
229656	93-X8-10128-2424-1V	Regatta Red	100
229682	93-X8-10128-9022-1V	Sharp Blue	100
229671	93-X8-10128-9011-1V	Shingle Grey	100
229693	93-X8-10128-9033-1V	Smoke Ring	100
229666	93-X8-10128-9006-1V	Taupe	100
229665	93-X8-10128-9005-1V	Toast	100
229696	93-X8-10128-9036-1V	True Brown	100
229624	93-X2-10128-9031-1V	Walden White	100
229902	93-X2-10128-1959-2V	White	1000
229654	93-X8-10128-1959-1V	White	100
229602	93-X2-10128-1959-1V	White	100
229658	93-X8-10128-3209-1V	Winter Wheat	100
229630	93-X2-10128-3209-1V	Winter Wheat	100

DOT® is a registered trademark of Scovill, Inc. Durable™ is a trademark of Scovill, Inc.



230881

DOT® Durable™ Mariner™

High ultraviolet resistant plastic cap with a super-strong, self-piercing eyelet. Size matches the standard all-brass construction DOT Durable button.

ITEM #	STYLE #	COLOR	STANDARD PACKAGE
230674	93-XV-10150-1Y	Beige	100
230681	93-XV-10150-1X	Black	100
230881	93-XV-10150-2X	Black	1000
230680	93-XV-10150-1V	White	100
230880	93-XV-10150-2V	White	1000

DOT® is a registered trademark of Scovill, Inc. Durable™ and Mariner™ are trademarks of Scovill, Inc. Durable™ is a trademark of Scovill, Inc.



H= multiple sizes available

DOT® Durable™

Durable Fasteners are a medium-sized heavy-duty button type snap fastener. They are used largely by manufacturers of boat covers, porch curtains and industrial curtains. These fasteners are available in nickel or black finish on brass. Sold only in full package lots of 100, 1,000 or 10,000 pieces where indicated. Certain durable fasteners meet Government Specification MS-27980.

ITEM #	STYLE #	DESCRIPTION	FINISH	FOR USE WITH	HAND TOOLS PART #	MACHINE TOOLS PART #	SIZE	STANDARD PACKAGE
230784	93-X2-10127-1B	Cap	Black Oxide	93-XB-10224-1A (#230705), 93-XB-10224-2A (#230901), 93-XB-10224-1C (#230781), 93-XB-10224-2C (#230896), 93-XB-10224-3A (#230891)	9936 (#223503)	1401 (#223501)	1/4 in. (H)	100
230888	93-X2-10127-2B	Cap	Black Oxide	93-XB-10224-1A (#230705), 93-XB-10224-2A (#230901), 93-XB-10224-1C (#230781), 93-XB-10224-2C (#230896), 93-XB-10224-3A (#230891)	9936 (#223503)	1401 (#223501)	1/4 in. (H)	1000
230780	93-X2-10128-1B	Cap	Black Oxide	93-XB-10224-1A (#230705), 93-XB-10224-2A (#230901), 93-XB-10224-1C (#230781), 93-XB-10224-2C (#230896), 93-XB-10224-3A (#230891)	9936 (#223503)	1401 (#223501)	11/64 in. (H)	100
230898	93-X2-10128-2B	Cap	Black Oxide	93-XB-10224-1A (#230705), 93-XB-10224-2A (#230901), 93-XB-10224-1C (#230781), 93-XB-10224-2C (#230896), 93-XB-10224-3A (#230891)	9936 (#223503)	1401 (#223501)	11/64 in. (H)	1000
230783	93-BS-10412-1C	Post	Black Oxide	93-BS-10370-1A (#230727), 93-BS-10370-2A (#230905), 93-BS-10370-1C (#230782), 93-BS-10370-2C (#230897), 93-BS-10370-3A (#230892)	9936 (#223503)	1407 (#223507)	1/4 in.	100
230895	93-BS-10412-2C	Post	Black Oxide	93-BS-10370-1A (#230727), 93-BS-10370-2A (#230905), 93-BS-10370-1C (#230782), 93-BS-10370-2C (#230897), 93-BS-10370-3A (#230892)	9936 (#223503)	1407 (#223507)	1/4 in. (H)	1000
230781	93-XB-10224-1C	Socket	Black Oxide	93-X2-10127-1A (#230701), 93-X2-10127-2A (#230899), 93-X2-10127-1B (#230784), 93-X2-10127-2B (#230888), 93-X2-10128-1A (#230702), 93-X2-10128-2A (#230899), 93-X2-10128-1B (#230780), 93-X2-10128-2B (#230898), 93-X2-10128-3A (#230890)	164H (#248160)	1410 (#223510)		100
230896	93-XB-10224-2C	Socket	Black Oxide	93-X2-10127-1A (#230701), 93-X2-10127-2A (#230899), 93-X2-10127-1B (#230784), 93-X2-10127-2B (#230888), 93-X2-10128-1A (#230702), 93-X2-10128-2A (#230899), 93-X2-10128-1B (#230780), 93-X2-10128-2B (#230898), 93-X2-10128-3A (#230890)	164H (#248160)	1410 (#223510)		1000
230787	93-XX-10224-2C	Socket	Black Oxide	93-X2-10127-1A (#230701), 93-X2-10127-2A (#230899), 93-X2-10127-1B (#230784), 93-X2-10127-2B (#230888), 93-X2-10128-1A (#230702), 93-X2-10128-2A (#230899), 93-X2-10128-1B (#230780), 93-X2-10128-2B (#230898), 93-X2-10128-3A (#230890)	164H (#248160)	1410 (#223510)		1000
230782	93-BS-10370-1C	Stud	Black Oxide	93-BS-10413-1A (#230741), 93-BS-10413-2A (#230924)	164H (#248160)	1412 (#223512)		100
230897	93-BS-10370-2C	Stud	Black Oxide	93-BS-10413-1A (#230741), 93-BS-10413-2A (#230924)	164H (#248160)	1412 (#223512)		1000
230863	93-BS-10379-3C	Stud	Black Oxide					10000

ITEM #	STYLE #	DESCRIPTION	FINISH	FOR USE WITH	HAND TOOLS PART #	MACHINE TOOLS PART #	SIZE	STANDARD PACKAGE
230701	93-X2-10127-1A	Cap	Nickel Plated	93-XB-10224-1A (#230705), 93-XB-10224-2A (#230901), 93-XB-10224-1C (#230781), 93-XB-10224-2C (#230896), 93-XB-10224-3A (#230891)	9936 (#223503)	1401 (#223501)	1/4 in. (H)	100
230899	93-X2-10127-2A	Cap	Nickel Plated	93-XB-10224-1A (#230705), 93-XB-10224-2A (#230901), 93-XB-10224-1C (#230781), 93-XB-10224-2C (#230896), 93-XB-10224-3A (#230891)	9936 (#223503)	1401 (#223501)	1/4 in. (H)	1000
230702	93-X2-10128-1A	Cap	Nickel Plated	93-XB-10224-1A (#230705), 93-XB-10224-2A (#230901), 93-XB-10224-1C (#230781), 93-XB-10224-2C (#230896), 93-XB-10224-3A (#230891)	9936 (#223503)	1401 (#223501)	11/64 in. (H)	100
230900	93-X2-10128-2A	Cap	Nickel Plated	93-XB-10224-1A (#230705), 93-XB-10224-2A (#230901), 93-XB-10224-1C (#230781), 93-XB-10224-2C (#230896), 93-XB-10224-3A (#230891)	9936 (#223503)	1401 (#223501)	11/64 in. (H)	1000
230890	93-X2-10128-3A	Cap	Nickel Plated				11/64 in. (H)	10000
230728	93-XB-10342-1A	Gypsy Stud	Nickel Plated	93-XB-10224-1A (#230705), 93-XB-10224-2A (#230901), 93-XB-10224-1C (#230781), 93-XB-10224-2C (#230896), 93-XB-10224-3A (#230891)		9557 (#275580)		100
230935	93-XB-10342-2A	Gypsy Stud	Nickel Plated	93-XB-10224-1A (#230705), 93-XB-10224-2A (#230901), 93-XB-10224-1C (#230781), 93-XB-10224-2C (#230896), 93-XB-10224-3A (#230891)		9557 (#275580)		1000
230740	93-BS-10412-1A	Post	Nickel Plated	93-BS-10370-1A (#230727), 93-BS-10370-2A (#230905), 93-BS-10370-1C (#230782), 93-BS-10370-2C (#230897), 93-BS-10370-3A (#230892)	9936 (#223503)	1407 (#223507)	1/4 in. (H)	100
230912	93-BS-10412-2A	Post	Nickel Plated	93-BS-10370-1A (#230727), 93-BS-10370-2A (#230905), 93-BS-10370-1C (#230782), 93-BS-10370-2C (#230897), 93-BS-10370-3A (#230892)	9936 (#223503)	9936 (#223503)	1/4 in. (H)	1000
230893	93-BS-10412-3A	Post	Nickel Plated				1/4 in. (H)	10000
230741	93-BS-10413-1A	Post	Nickel Plated	93-BS-10370-1A (#230727), 93-BS-10370-2A (#230905), 93-BS-10370-1C (#230782), 93-BS-10370-2C (#230897), 93-BS-10370-3A (#230892)	9936 (#223503)	1407 (#223507)	5/16 in. (H)	100
230924	93-BS-10413-2A	Post	Nickel Plated	93-BS-10370-1A (#230727), 93-BS-10370-2A (#230905), 93-BS-10370-1C (#230782), 93-BS-10370-2C (#230897), 93-BS-10370-3A (#230892)	9936 (#223503)	1407 (#223507)	5/16 in. (H)	1000
230743	93-BS-10414-1A	Post	Nickel Plated	93-BS-10370-1A (#230727), 93-BS-10370-2A (#230905), 93-BS-10370-1C (#230782), 93-BS-10370-2C (#230897), 93-BS-10370-3A (#230892)	9936 (#223503)	1407 (#223507)	3/8 in. (H)	100
230926	93-BS-10414-2A	Post	Nickel Plated	93-BS-10370-1A (#230727), 93-BS-10370-2A (#230905), 93-BS-10370-1C (#230782), 93-BS-10370-2C (#230897), 93-BS-10370-3A (#230892)	9936 (#223503)	1407 (#223507)	3/8 in. (H)	1000
230737	93-XB-103934-4A	Screw Stud	Nickel Plated		169 N			100
230921	93-XB-103937-2A	Screw Stud	Nickel Plated		169 N		5/8 in.	1000
230756	93-XB-103937-4A	Screw Stud	Nickel Plated		169 N		5/8 in.	100
230749	93-XB-107084-1A	Screw Stud	Nickel Plated		169 N		3/8 in.	100
230753	93-XB-107087-1A	Screw Stud	Nickel Plated		169 N		5/8 in.	100
230705	93-XB-10224-1A	Socket	Nickel Plated	93-X2-10127-1A (#230701), 93-X2-10127-2A (#230899), 93-X2-10127-1B (#230784), 93-X2-10127-2B (#230888), 93-X2-10128-1A (#230702), 93-X2-10128-2A (#230899), 93-X2-10128-1B (#230780), 93-X2-10128-2B (#230898), 93-X2-10128-3A (#230890)	164H (#248160)	1410 (#223510)		100
230901	93-XB-10224-2A	Socket	Nickel Plated	93-X2-10127-1A (#230701), 93-X2-10127-2A (#230899), 93-X2-10127-1B (#230784), 93-X2-10127-2B (#230888), 93-X2-10128-1A (#230702), 93-X2-10128-2A (#230899), 93-X2-10128-1B (#230780), 93-X2-10128-2B (#230898), 93-X2-10128-3A (#230890)	164H (#248160)	1410 (#223510)		1000
230891	93-XB-10224-3A	Socket	Nickel Plated					10000
230930	93-XB-10231-2A	Socket	Nickel Plated	93-X2-10127-1A (#230701), 93-X2-10127-2A (#230899), 93-X2-10127-1B (#230784), 93-X2-10127-2B (#230888), 93-X2-10128-1A (#230702), 93-X2-10128-2A (#230899), 93-X2-10128-1B (#230780), 93-X2-10128-2B (#230898), 93-X2-10128-3A (#230890)	164H (#248160)	1410 (#223510)		1000

ITEM #	STYLE #	DESCRIPTION	FINISH	FOR USE WITH	HAND TOOLS PART #	MACHINE TOOLS PART #	SIZE	STANDARD PACKAGE
230706	93-XX-10224-1A	Socket	Nickel Plated	93-X2-10127-1A (#230701), 93-X2-10127-2A (#230899), 93-X2-10127-1B (#230784), 93-X2-10127-2B (#230888), 93-X2-10128-1A (#230702), 93-X2-10128-2A (#230899), 93-X2-10128-1B (#230780), 93-X2-10128-2B (#230898), 93-X2-10128-3A (#230890)	164H (#248160)	1410 (#223510)		100
230917	93-XX-10224-2A	Socket	Nickel Plated	93-X2-10127-1A (#230701), 93-X2-10127-2A (#230899), 93-X2-10127-1B (#230784), 93-X2-10127-2B (#230888), 93-X2-10128-1A (#230702), 93-X2-10128-2A (#230899), 93-X2-10128-1B (#230780), 93-X2-10128-2B (#230898), 93-X2-10128-3A (#230890)	164H (#248160)	1410 (#223510)		1000
230727	93-BS-10370-1A	Stud	Nickel Plated	93-BS-10412-1A (#230740), 93-BS-10412-2A (#230912), 93-BS-10412-1C (#230783), 93-BS-10412-2C (#230895), 93-BS-10412-3A (#230893)	164H (#248160)	1412 (#223512)		100
230905	93-BS-10370-2A	Stud	Nickel Plated	93-BS-10412-1A (#230740), 93-BS-10412-2A (#230912), 93-BS-10412-1C (#230783), 93-BS-10412-2C (#230895), 93-BS-10412-3A (#230893)	164H (#248160)	1412 (#223512)		1000
230892	93-BS-10370-3A	Stud	Nickel Plated					10000
230916	93-BS-10379-2A	Stud	Nickel Plated					1000
230744	93-BS-10379-4A	Stud	Nickel Plated					100
230918	93-XB-103934-2A	Stud	Nickel Plated		169 N			1000
231063	93-XX-10222-1A	Veltex Carpet Snap Socket	Nickel Plated					100
230934	93-X8-103015-2A	Screw Stud	Nickel Plated/Stainless Steel Screw		169 N		7/16 in.	1000
230764	93-X8-103015-4A	Screw Stud	Nickel Plated/Stainless Steel Screw		169 N		7/16 in.	100
230936	93-X8-103017-2A	Screw Stud	Nickel Plated/Stainless Steel Screw		169 N		5/8 in.	1000
230766	93-X8-103017-4A	Screw Stud	Nickel Plated/Stainless Steel Screw		169 N		5/8 in.	100
230938	93-X8-103025-2A	Screw Stud	Nickel Plated/Stainless Steel Screw		169 N		7/16 in.	1000
230768	93-X8-103025-4A	Screw Stud	Nickel Plated/Stainless Steel Screw		169 N		7/16 in.	100
230939	93-X8-103027-2A	Screw Stud	Nickel Plated/Stainless Steel Screw		169 N		5/8 in.	1000
230769	93-X8-103027-4A	Screw Stud	Nickel Plated/Stainless Steel Screw		169 N		5/8 in.	100
230911	93-X8-103934-2A	Screw Stud	Nickel Plated/Stainless Steel Screw		169 N		3/8 in.	1000
230739	93-X8-103934-4A	Screw Stud	Nickel Plated/Stainless Steel Screw		169 N		3/8 in.	100
230923	93-X8-103937-2A	Screw Stud	Nickel Plated/Stainless Steel Screw		169 N		5/8 in.	1000
230758	93-X8-103937-4A	Screw Stud	Nickel Plated/Stainless Steel Screw		169 N		5/8 in.	100
230760	93-X8-103938-1A	Screw Stud	Nickel Plated/Stainless Steel Screw	93-XB-10224-1A (#230705), 93-XB-10224-2A (#230901), 93-XB-10224-1C (#230781), 93-XB-10224-2C (#230896), 93-XX-10224-2C (#230787), 93-XX-10224-1A (#230706), 93-XX-10224-2A (#230917), 93-XB-10224-3A (#230891)	169N (#275504)		1 in.	100
230931	93-X8-103938-2A	Screw Stud	Nickel Plated/Stainless Steel Screw		169 N		1 in.	1000
231117	93-X8-107044-1A	Screw Stud	Nickel Plated/Stainless Steel Screw					100
230850	93-X8-109344-2A	Screw Stud	Nickel Plated/Stainless Steel Screw				3/8 in.	1000
230723	93-X8-109344-4A	Screw Stud	Nickel Plated/Stainless Steel Screw				3/8 in.	100
230851	93-X8-109347-2A	Screw Stud	Nickel Plated/Stainless Steel Screw				5/8 in.	1000
230765	93-X8-109347-4A	Screw Stud	Nickel Plated/Stainless Steel Screw				5/8 in.	100

ITEM #	STYLE #	DESCRIPTION	FINISH	FOR USE WITH	HAND TOOLS PART #	MACHINE TOOLS PART #	SIZE	STANDARD PACKAGE
230913	93-XX-103624-2A	Screw Stud	Nickel Plated/Steel Screw		169 N		3/8 in.	1000
230713	93-XX-103624-4A	Screw Stud	Nickel Plated/Steel Screw		169 N		3/8 in.	100
230922	93-XX-103627-2A	Screw Stud	Nickel Plated/Steel Screw		169 N		5/8 in.	1000
230715	93-XX-103627-4A	Screw Stud	Nickel Plated/Steel Screw		169 N		5/8 in.	100
230501	93-XN-10135-1U	Snap Cap / Open Top Button / Pilot Hole Cap	Stainless Steel					100

DOT® is a registered trademark of Scovill, Inc. Durable™ is a trademark of Scovill, Inc.

DOT® Durable™ Stainless



231008

ITEM #	STYLE #	DESCRIPTION	MATERIAL	SIZE	STANDARD PACKAGE
231008	93-XN-10616-2U	Buckle	Stainless Steel		1000
230655	93-X8-10127-1A	Cap	Nickel Plated Brass / Stainless Steel Post		100
230967	93-X8-10127-2A	Cap	Nickel Plated Brass / Stainless Steel Post		1000
230655	230669	93-X8-10128-1A	Cap	Nickel Plated Brass / Stainless Steel Post	100
230670	93-XN-10127-1U	Cap	Stainless Steel		100
231000	93-XN-10127-2U	Cap	Stainless Steel		1000
230974	93-XN-10128-2U	Cap	Stainless Steel		1000
230667	230664	93-XN-10128-4U	Cap	Stainless Steel	100
230676	93-ZN-10127-1U	Cap	Stainless Steel	1/4 in. (H)	100
230677	93-ZN-10128-2U	Cap	Stainless Steel	11/64 in. (H)	1000
230665	93-ZN-10128-1U	Cap	Stainless Steel		100
230975	93-ZN-10128-2U	Cap	Stainless Steel		1000
230692	93-ZS-10413-1U	Cap	Stainless Steel	5/16 in. (H)	100
230667	93-NS-10412-1U	Post	Stainless Steel		100
230977	93-NS-10412-2U	Post	Stainless Steel		1000
230687	93-ZS-10412-1U	Post	Stainless Steel	1/4 in. (H)	100
230690	93-ZS-10412-2U	Post	Stainless Steel	1/4 in. (H)	1000
230693	93-ZS-10413-2U	Post	Stainless Steel	5/16 in. (H)	1000
230659	93-XN-103934-1U	Screw Stud	Stainless Steel	3/8 in.	100
230970	93-XN-103934-2U	Screw Stud	Stainless Steel	3/8 in.	1000
230661	93-XN-103937-1U	Screw Stud	Stainless Steel	5/8 in.	100
230971	93-XN-103937-2U	Screw Stud	Stainless Steel	5/8 in.	1000
230969	93-XN-10224-2U	Socket	Stainless Steel		1000
230657	93-XN-10224-4U	Socket	Stainless Steel		100
230972	93-ZN-10224-1U	Socket	Stainless Steel		100
230973	93-ZN-10224-2U	Socket	Stainless Steel		1000
230666	93-NS-10370-1U	Stud	Stainless Steel		100
230976	93-NS-10370-2U	Stud	Stainless Steel		1000
230983	93-ZS-10370-1U	Stud	Stainless Steel		100
230984	93-ZS-10370-2U	Stud	Stainless Steel		1000

DOT® is a registered trademark of Scovill, Inc. Durable™ is a trademark of Scovill, Inc.

Washer – Screw Stud

ITEM #	MATERIAL	STANDARD PACKAGE
296005	Nylon	1000



231085

Fasnap® Rib Tree Bolster Fasteners

This 3/4 inch panel fastener with ribbed shank assures easy installation and secure hold. One ribbed end is pushed into primary panel to retain clip. Second panel is pushed down onto projecting ribbed end to complete the assembly.

ITEM #	DESCRIPTION	STANDARD PACKAGE
231085	3/4 in. double end clip with inner stop 1/2 in. x 7/8 in.	100

FASNAP® is a registered trademark of The FASNAP Corporation



231026



231027



231096



230671



230960



230696



230767



230691



230694

Fasnap® Fasteners

High rust and corrosion resistant button, normal action socket, stud, and eyelet. The button and eyelet are, in many instances, able to self-pierce through multiple layers of fabric. All four components are interchangeable with nickel-plated brass screw studs or other snap fasteners and tools, eliminating special die requirements.

ITEM #	STYLE #	DESCRIPTION	FINISH	STANDARD PACKAGE	TYPE
231026	BN4647AR	Cap	Nickel Plated	1000	
231027	BN4647B	Socket	Nickel Plated	1000	
231096	BHST705916	Screw Stud	Nickel/Brass Stud, Stainless Steel Screw	100	1/2 in. #8 Hardened TEK® Screw
230671	BNCT705916	Screw Stud	Nickel/Brass Stud, Stainless Steel Screw	100	1/2 in. #8 TEK® Screw
230688	SSC4650AR	Button	Stainless Steel	100	
230960	SS4650AR	Cap	Stainless Steel	1000	
230968	SC4647D/SS4647D	Post	Stainless Steel	1000	
230696	SSC4647D	Post	Stainless Steel	100	
230767	BNSC705921	Oversized Screw Stud	Stainless Steel	100	5/8 in. #10 Screw
230691	SSC4650B	Socket	Stainless Steel	100	
230963	SSC4650B/SS4650B	Socket	Stainless Steel	1000	
230694	SSC4650C	Stud	Stainless Steel	100	
230966	SSC4650C/SS4650C	Stud	Stainless Steel	1000	

FASNAP® is a registered trademark of The FASNAP Corporation. TEK® is a registered trademark of ITW Buildex Corp.

DOT® Lift-The-Dot®



230637

Featured below are styles available, complete with parts indicated. Sold only in full package lots of 100 pieces or 1000 pieces. Lift-The-Dot Fasteners are available in nickel or black finish. Certain Lift-The-Dot fasteners meet Government Specification MS-27977. Strong and heavy duty, Lift-The-Dot fasteners lock on three sides and are opened by lifting the fourth side where the Dot and the Lift-The-Dot trademark appear.



230601



230628



230608



230610



230620



230636



230638



230630

ITEM #	STYLE #	DESCRIPTION	FINISH	FOR USE ON	FOR USE WITH	HAND TOOLS PART #	MACHINE TOOLS PART #	SIZE	STANDARD PACKAGE
230956	90-PS-16510-29	Washer		Canvas	90-XX-16205-1A (#230601), 90-XX-16205-2A (#230940), 90-XX-16205-1B (#230649), 90-XX-16205-2B (#230978), 90-BS-16506-1A (#230637), 90-BS-16506-2A (#230647), 90-BS-16506-2C (#230979)				1000
230656	90-PS-16510-49	Washer		Canvas	90-XX-16205-1A (#230601), 90-XX-16205-2A (#230940), 90-XX-16205-1B (#230649), 90-XX-16205-2B (#230978), 90-BS-16506-1A (#230637), 90-BS-16506-2A (#230647), 90-BS-16506-2C (#230979)				100
230979	90-BS-16506-2C	Back Plate	Black Oxide	Canvas	90-XX-16205-1A (#230601), 90-XX-16205-2A (#230940), 90-XX-16205-1B (#230649), 90-XX-16205-2B (#230978), 90-XX-16206-1A (#230602), 90-XX-16206-2A (#230647), 90-XX-16206-2B (#230654)		1455 (#223555)		1000
230649	90-XX-16205-1B	Socket	Black Oxide	Canvas	90-BS-16506-1A (#230637), 90-BS-16506-2A (#230951), 90-BS-16506-2C (#230979), 90-PS-16510-19 (#230656), 90-PS-16510-29 (#230956)		1454 (#223554)		100
230978	90-XX-16205-2B	Socket	Black Oxide	Canvas	90-BS-16506-1A (#230637), 90-BS-16506-2A (#230951), 90-BS-16506-2C (#230979), 90-PS-16510-19 (#230656), 90-PS-16510-29 (#230956)		1454 (#223554)		1000
230654	90-XX-16206-2B	Socket	Black Oxide				1454		1000
230651	90-XB-16358-2B	Stud	Black Oxide	Canvas	90-BS-16509-1A (#230638), 90-BS-16509-2A (#230952), 90-BS-16509-2C (#230652)		1456 (#223556)		1000
230652	90-BS-16509-2C	Washer	Black Oxide	Canvas	90-XB-16358-1A (#230610), 90-XB-16358-2A (#230944), 90-XB-16358-2B (#230651)		1457 (#223557)		1000
230637	90-BS-16506-1A	Back Plate	Nickel Plated	Canvas	90-XX-16205-1A (#230601), 90-XX-16205-2A (#230940), 90-XX-16205-1B (#230649), 90-XX-16205-2B (#230978), 90-XX-16206-1A (#230602), 90-XX-16206-2A (#230647), 90-XX-16206-2B (#230654)				100
230951	90-BS-16506-2A	Back Plate	Nickel Plated	Canvas	90-XX-16205-1A (#230601), 90-XX-16205-2A (#230940), 90-XX-16205-1B (#230649), 90-XX-16205-2B (#230978), 90-XX-16206-1A (#230602), 90-XX-16206-2A (#230647), 90-XX-16206-2B (#230654)	9940 (#275573)	1455 (#223555)		1000
230603	90-XB-163174-1A	Screw Stud	Nickel Plated	Wood			169B		3/8 in. 100
230601	90-XX-16205-1A	Socket Short Prong	Nickel Plated	Canvas	90-BS-16506-1A (#230637), 90-BS-16506-2A (#230951), 90-BS-16506-2C (#230979), 90-PS-16510-19 (#230656), 90-PS-16510-29 (#230956)		1454 (#223554)		100
230940	90-XX-16205-2A	Socket	Nickel Plated	Canvas	90-BS-16506-1A (#230637), 90-BS-16506-2A (#230951), 90-BS-16506-2C (#230979), 90-PS-16510-19 (#230656), 90-PS-16510-29 (#230956)		1454 (#223554)		1000
230602	90-XX-16206-1A	Socket Long Prong	Nickel Plated	Canvas	90-BS-16506-1A (#230637), 90-BS-16506-2A (#230951), 90-BS-16506-2C (#230979), 90-PS-16510-19 (#230656), 90-PS-16510-29 (#230956)		1454 (#223554)		100
230647	90-XX-16206-2A	Socket	Nickel Plated	Canvas	90-BS-16506-1A (#230637), 90-BS-16506-2A (#230951), 90-BS-16506-2C (#230979), 90-PS-16510-19 (#230656), 90-PS-16510-29 (#230956)		1454 (#223554)		1000

ITEM #	STYLE #	DESCRIPTION	FINISH	FOR USE ON	FOR USE WITH	HAND TOOLS PART #	MACHINE TOOLS PART #	SIZE	STANDARD PACKAGE
230628	90-XB-16347-1A	Stud with 2-Hole Plate	Nickel Plated	Wood					100
230608	90-BS-16349-1A	Stud	Nickel Plated	Canvas	90-BS-16501-1A (#230636)	171 (#275575)			100
230610	90-XB-16358-1A	Stud	Nickel Plated	Canvas	90-BS-16509-1A (#230638), 90-BS-16509-2A (#230952), 90-BS-16509-2C (#230652)	9940 (#275573)	1456 (#223556)		100
230944	90-XB-16358-2A	Stud	Nickel Plated	Canvas	90-BS-16509-1A (#230638), 90-BS-16509-2A (#230952), 90-BS-16509-2C (#230652)	9940 (#275573)	1456 (#223556)		1000
231120	90-XB-16368-1A	Stud	Nickel Plated	Canvas, Metal, Plastic	90-XX-16205-1A (#230601), 90-XX-16205-2A (#230940), 90-XX-16205-1B (#230649), 90-XX-16205-2B (#230978), 90-XX-16206-1A (#230602), 90-XX-16206-2A (#230647), 90-XX-16206-2B (#230654)	9940 (#275573)			100
230636	90-BS-16501-1A	Washer	Nickel Plated	Canvas	90-BS-16349-1A (#230608)		8042 (#275480)		100
230638	90-BS-16509-1A	Washer	Nickel Plated	Canvas	90-XB-16358-1A (#230610), 90-XB-16358-2A (#230944), 90-XB-16358-2B (#230651)		1457 (#223557)		100
230952	90-BS-16509-2A	Washer	Nickel Plated	Canvas	90-XB-16358-1A (#230610), 90-XB-16358-2A (#230944), 90-XB-16358-2B (#230651)		1457 (#223557)		1000
230618	90-XB-163624-1A	Screw Stud	Nickel Plated/Brass Screw	Metal		169B		3/8 in.	100
230630	90-X8-16376-1A	Windshield Clip 3/4 in.	Nickel Plated/Stainless Steel Clip						100
230633	90-X8-16377-1A	Windshield Clip 7/8 in.	Nickel Plated/Stainless Steel Clip						100
230624	90-X8-163604-4A	Screw Stud	Nickel Plated/Stainless Steel Screw	Wood		169B		3/8 in.	100
230955	90-X8-163606-2A	Screw Stud	Nickel Plated/Stainless Steel Screw	Wood, Metal, Plastic		169B		1/2 in.	1000
230620	90-X8-163606-4A	Screw Stud	Nickel Plated/Stainless Steel Screw	Wood, Metal, Plastic		169B		1/2 in.	100
231125	90-X8-163607-1A	Screw Stud	Nickel Plated/Stainless Steel Screw	Metal, Plastic		169B (#275502)			100

DOT® and Lift-The-Dot® are registered trademarks of Scovill, Inc.

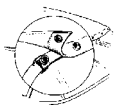

Windshield Clip

Top Snap Fasteners snap over a boat windshield channel, eliminating need for drilling holes through the windshield. The clip portion of the Top Snap Fastener is made of stainless steel to resist corrosion. Socket portion is made of nickel-plated brass. DOT® Durable™ Button and Sockets are inserted through fabric top, then snapped onto the Top Snap Fastener.



230909



230745

ITEM #	STYLE #	DESCRIPTION	FINISH	SIZE	STANDARD PACKAGE
230738	93-XX-10388-1A	Windshield Clip	Nickel Plated/Stainless Steel Clip	3/4 in. x 9/16 in.	100
230909	93-XX-10388-2A	Windshield Clip	Nickel Plated/Stainless Steel Clip	3/4 in. x 9/16 in.	1000
230745	93-XX-10391-1A	Windshield Clip	Nickel Plated/Stainless Steel Clip	7/8 in. x 9/16 in.	100
230910	93-XX-10391-2A	Windshield Clip	Nickel Plated/Stainless Steel Clip	7/8 in. x 9/16 in.	1000

DOT® is a registered trademark of Scovill, Inc. Durable™ is a trademark of Scovill, Inc.

DOT® Pull-The-Dot®



230800

The Pull-The-Dot Fastener is a side-locking snap fastener, similar to the Durable™ Glove-style fastener, except for its "built-in" locking feature. This fastener will withstand extreme pressure on three sides without unlocking, yet will release instantly on the fourth side if one "pulls the dot" embossed on one side of the button. Pull-The-Dots have no sharp edges or protrusions to tear or mar the fabric to be fastened.

Since the socket opens only on one side, care must be taken that the button and socket are set so that the fastener can be opened at the desired position.



230801



230823

ITEM #	STYLE #	DESCRIPTION	FINISH	STANDARD PACKAGE
230819	92-XE-18100-A2B	Cap	Black Oxide	1000
230842	92-XX-18201-2C	Socket	Black Oxide	1000
230799	92-BS-18303-2C	Stud	Black Oxide	1000
230820	92-XE-18100-A2A	Cap	Nickel	1000
230800	92-XE-18100-A4A	Cap	Nickel	100
230821	92-XX-18201-2A	Socket	Nickel	1000
230801	92-XX-18201-4A	Socket	Nickel	100
230822	92-BS-18303-2A	Stud	Nickel	1000
230802	92-BS-18303-4A	Stud	Nickel	100
230803	92-X8-183074-1A	Stud	Nickel/Stainless Steel Screw	100
230823	92-X8-183074-2A	Stud	Nickel/Stainless Steel Screw	1000

DOT® and Pull-The-Dot® are registered trademarks of Scovill, Inc. Durable™ is a trademark of Scovill, Inc.

Q-Snap® Fasteners

The patented Q-Snap system is similar to the standard press-fastener, with the exception of two additional parts: a ring underneath the cloth and a hook on the deck. This combination turns the fastener into a secured connection that won't pop loose, while incorporating a stretch-function that acts as a lever. The result allows you to easily overcome the cloth tension as you fit the fastener.

Installation is like a normal press fastener, but with special tools that make it faster than other secured fasteners. There are no extra parts, thanks to smart pre-assembly.

Resistant to seawater, Q-Snap is made from high quality 316 stainless steel. The special ring spring in the socket is dimensionally stable and even more resistant to corrosion than 316 stainless steel. A thin rubber layer isolates the Q-stud to prevent tension corrosion. Above all, it is the only secured fastener without moving parts, making it very durable and robust.

Developed for covers and sprayhoods on boats, Q-Snap is an ideal solution for any application that requires textiles to be tight and secure.

Starter Kit includes: 50 Q-Caps, 50 Q-Sockets, 25 Q-Studs (including screw), 25 Q-Studs, 25 screws, 25 M4 bolts, 25 self-drilling screws, 25 eyelets, 5 blind rivets, Q-Stud holder, Q-Stud marker, 5 Q-Installation pins, 5 Q-Stud covers, hand punch set, 25 ringlets and 25 plugs.

DIY Pack includes: 10 polished Q-Caps, 10 Q-Sockets, Q-Studs with screws and hand punch tool.

ITEM #	STYLE #	DESCRIPTION	COLOR	MATERIAL	STANDARD PACKAGE
231161	150000-10	DIY Pack			1
231155	141300-100	Fixing Blind Rivet		Stainless Steel Type 304	100
231156	140500-100	Fixing Eyelet		Stainless Steel Type 316	100
231153	140200-100	Fixing M4 Bolt		Stainless Steel Type 316	100
231154	141400-100	Fixing Self-Drilling Screw		Stainless Steel Type 304	100
231152	140100-100	Fixing Tapping Screw		Stainless Steel Type 316	100
231148	110100-100	Q-Cap Long Shaft 6.2mm	Polished	Stainless Steel Type 316	100
231142	110002-100	Q-Cap Normal Shaft 4mm	Black Matte	Stainless Steel Type 316	100
231141	110001-100	Q-Cap Normal Shaft 4mm	Black	Stainless Steel Type 316	100
231147	110007-100	Q-Cap Normal Shaft 4mm	Bordeaux Red	Stainless Steel Type 316	100
231144	110004-100	Q-Cap Normal Shaft 4mm	Grey	Stainless Steel Type 316	100
231145	110005-100	Q-Cap Normal Shaft 4mm	Khaki	Stainless Steel Type 316	100
231146	110006-100	Q-Cap Normal Shaft 4mm	Navy Blue	Stainless Steel Type 316	100
231143	110003-100	Q-Cap Normal Shaft 4mm	Pearl White	Stainless Steel Type 316	100
231140	110000-100	Q-Cap Normal Shaft 4mm	Polished	Stainless Steel Type 316	100
231164	190400-10	Q-Installation Pin			10
231165	190400-25	Q-Installation Pin			25
231149	120000-100	Q-Socket Integrated Socket and Ring		Stainless Steel Type 316	100
231166	190100-10	Q-Stud Cover	Grey		10
231167	190101-10	Q-Stud Cover	Off-White		10
231162	190200-1	Q-Stud Holder			1
231163	190300-1	Q-Stud Marker			1
231151	130100-100	Q-Stud with Tapping Screw		Stainless Steel Type 316	100
231150	130000-100	Q-Stud		Stainless Steel Type 316	100
231160	150000-1	Starter Kit			1

Q-Snap® is a registered trademark of Partnership Twello B.V.



231016

Snapfast® System

The Snapfast fastening system offers an alternative to traditional all-metal directional fasteners. This non-corrosive directional fastening system has no moving parts and unlocks from one direction only. The sockets and studs are manufactured from heavy-duty polyacetal with a UV stabilizer. Snapfast's stainless steel pronged cap self-pierces most industrial fabrics and installs easily using hand tools.



231014



231015

ITEM #	STYLE #	DESCRIPTION	COLOR	FINISH	STANDARD PACKAGE
231045	SNPFSTLA	Long Pronged Cap		Stainless Steel	100
231016	SNPFSTA	Pronged Cap		Stainless Steel	100
231014	SNPTSTB	Socket	Black		100
231046	SNPFSTBW	Socket	White		100
231015	SNPFSTC	Stud	Black		100
231047	SNPFSTCW	Stud	White		100

Snapfast® is a registered trademark of The FASNAP Corporation.



289264

Stayput™ Fasteners

"Stayput" for a secure and corrosion free fastening solution. Stayput canvas fasteners have no springs to corrode or jam. They are manufactured from UV stabilized nylon and acetyl compounds. Originally designed for the marine market, are now used extensively in all areas of fabric fastening.



289281



289284



289270

ITEM #	STYLE #	DESCRIPTION	COLOR	STANDARD PACKAGE
289264	87B	Attach Knob	Black	100
289265	86W	Attach Knob	White	100
289276	40W	Canvas to Canvas Double	White	100
289266	37B	Horizontal Single	Black	100
289268	37W	Horizontal Single	White	100
289281	50B	Tent Wall Hook	Black	100
289280	50W	Tent Wall Hook	White	100
289262	48B	Tent Wall J-Hook	Black	100
289263	48W	Tent Wall J-Hook	White	100
289293	71B	Ultimate Clip Back	Black	100
289292	71W	Ultimate Clip Back	White	100
289284	70B	Ultimate Shock Cord Clip	Black	100
289283	70W	Ultimate Shock Cord Clip	White	100
289273	35W	Vertical Double	White	100
289270	34B	Vertical Single	Black	100
289272	34W	Vertical Single	White	100

Stayput™ is a trademark of Stayput Fasteners.



231065



231077

YKK® SNAD® Pressure Sensitive Fasteners

The YKK® SNAD® fastener is a durable, innovative snap fastener that attaches to various substrates and surfaces using a sophisticated, and proven adhesive. This eliminates having to drill holes in surfaces to mount the fastener.

ITEM #	STYLE #	DESCRIPTION	COLOR	DIAMETER	SIZE	STANDARD PACKAGE
231071	PG1-0000-A01	Domed Socket	Black	1-9/16 in.	40 mm	100
231068	PG1-0000-839	Domed Socket	White	1-9/16 in.	40 mm	100
231108	QW9-0000-A01	Domed Stud	Black	1 in.	25 mm	100
231065	PG3-0000-A01	Domed Stud	Black	1-9/16 in.	40 mm	100
231069	PG3-0000-839	Domed Stud	White	1-9/16 in.	40 mm	100
231107	QW9-0000-839	Domed Stud	White	1 in.	25 mm	100
231078	TR5-0000-TVO	Flexible Base Socket	Clear	1 in.	25 mm	100
231077	QL7-0000-QK1	Flexible Base Stud	Black	1 in.	25 mm	100
231076	TP9-0000-TVO	Flexible Base Stud	Clear	1 in.	25 mm	100
231079	TT5-0000-TVO	Flexible Base Stud	Clear	1-9/16 in.	40 mm	100
231075	QL7-0000-PX7	Flexible Base Stud	Gray	1 in.	25 mm	100
231073	QL7-0000-QP3	Flexible Base Stud	White	1 in.	25 mm	100

YKK® and SNAD® are registered trademarks of YKK Corporation in Japan and other countries/regions.



231087

T Nut Fastener

ITEM #	STYLE #	FINISH	MATERIAL	SIZE	STANDARD PACKAGE
230980	ST29-444		Stainless Steel	1/4-20	1000
231087	T29-444	Zinc Plated	Steel	1/4-20	1000



251997

Suction Cup

A solution to your “no hardware” needs, this giant suction cup has 60 pounds of holding power. Secures to any smooth surface. Ideal for “rack storage” boat covers.

ITEM #	STYLE #	CORD SIZE	SIZE	STANDARD PACKAGE	STRETCH SIZE
251997	CT6	6 in.	3-1/2 in.	1	11 in.



287820

Boat Top Fittings – Aluminum – Boat Cover Socket

Cast aluminum alloy. Ideal to keep boat covers from sagging. Use with Trivantage® Fiberglass Bow Slats to support boat cover. Two screw holes drilled for No. 8 screw.

ITEM #	STYLE #	SIZE	STANDARD PACKAGE
287820	440-22	5/8 in. height, 1-7/8 in. x 1/2 in opening, 3-1/2 in. x 7/8 in. base	10

Trivantage® is a registered trademark of Glen Raven, Inc.



282146

Boat Top Fittings – Aluminum – Insert Eye End

When inserted, flange of Eye End is flush with outside of tubing. Must be secured by means of crimping tool or rivet. For use with Deck Mounting and Angle Hinges.

ITEM #	STYLE #	FOR	STANDARD PACKAGE
282146	4434-12	3/4 in. OD tube, 5/8 in. ID tube	10
282149	4436-16	7/8 in. ID tube, 3/4 in. ID tube	10



282149



282142



281104

Boat Top Fittings – Aluminum – Slip Fit Eye End

With stainless steel set screw.

ITEM #	STYLE #	FOR	STANDARD PACKAGE
282142	422-3S	3/8 in. pipe	10
281105	424-4S	1/2 in. pipe, 7/8 in. OD tube	10
281104	424-4S	1/2 in. pipe, 7/8 in. OD tube	10
282143	433-7S	3/4 in. OD tube	10
282150	438-10S	1 in. OD tube	10



282143



282150

281104 - With square head set screw.



284047

Boat Top Fittings – Aluminum – Deck Mounting Hinge

ITEM #	STYLE #	PROJECTION	STANDARD PACKAGE
284047	477-2A	3/4 in.	10
284049	478-523	1-1/8 in.	10



284049



284050

Boat Top Fittings – Aluminum – Pontoon Deck Hinge

90° aluminum deck hinge designed for use on pontoon boats with 1 inch square aluminum tubing. Made from 6063-T6 extruded aluminum with satin anodization for uniform finish. Requires a 1/4 inch diameter pull pin.

ITEM #	STYLE #	STANDARD PACKAGE
284050	BH76	10



287688

Boat Top Fittings – Aluminum – Jaw Slide

Equipped with stainless set screw, and round head machine screw.

ITEM #	STYLE #	FOR	STANDARD PACKAGE
287688	458-5042	1/2 in. pipe, 7/8 in. OD tube	10
287650	468-70J	1 in. OD tube	10



287647

Boat Top Fittings – Aluminum – Pontoon Jaw Slide

Designed for use on pontoon boats with 1 inch square aluminum tubing. Made from 6063T6 extruded aluminum with satin anodization for uniform finish. A 1/4 – 20 x 5/16 inch stainless steel socket set screw, a 1/4 – 20 stainless steel hex head shoulder bolt and a nylok hex nut are included.

ITEM #	STYLE #	FOR	STANDARD PACKAGE
287647	BH74	1 in. square tube	10



287640

Boat Top Fittings – Aluminum – Pontoon H Bracket

Designed for use on pontoon boats with 1-1/4 inch square aluminum tubing. Includes bolt and nut.

ITEM #	DESCRIPTION	FOR	STANDARD PACKAGE
287640	Standard Thin Wall	1-1/4 in. square tube	10
287642	Tall	1-1/4 in. square tube	10



239960

Boat Top Fittings – Aluminum – Tower Clamp

These Tower Clamps with knobs are designed for use with eye ends to attach Bimini frame hardware to a tower on large cruisers and sport fishing vessels.

ITEM #	STYLE #	SIZE	STANDARD PACKAGE
239959	200960	1-1/2 in.	10
239960	200980	2-1/8 in.	10
239961	200999	2-3/8 in.	10

Tubing – Marine – Aluminum

This bright dip anodized, drawn aluminum tubing is ideal. Less than full cartons are not recommended.

ITEM #	STYLE #	DESCRIPTION	LENGTH	OUTSIDE DIAMETER	STANDARD PACKAGE	WALL	WEIGHT PER CARTON	WEIGHT PER FOOT
275708		Round	20 ft.	3/4 in.	1080	0.058 in.	160 lbs.	0.0148 lbs.
275714		Round	24 ft.	7/8 in.	432	0.058 in.	70 lbs.	0.1750 lbs.
275712		Round	20 ft.	7/8 in.	360	0.058 in.	70 lbs.	0.1750 lbs.
275711		Round	20 ft.	7/8 in.	360	0.065 in.	84 lbs.	0.2100 lbs.
275719	6111-18	Round	24 ft.	7/8 in.	432	0.065 in.	92 lbs.	0.2100 lbs.
275713		Round	20 ft.	7/8 in.	360	0.095 in.	110 lbs.	0.2750 lbs.
275718	6154	Square	24 ft.	1 in.	24	0.062 in.	178 lbs.	0.2650 lbs.



205381

Bimini Bow Frames

Bow Bimini top kit (minus fabric). Comes in ready-to-assemble kit form. Packaged one boat set per box with hardware. Made with 7/8 in. outside diameter by 0.058 wall 6063, T832 hard drawn marine aluminum tubing with a brite anodized finish and joined together with inside sleeves. The radius of the bends is 6 in. inside diameter.

ITEM #	STYLE #	DESCRIPTION	MATERIAL	STANDARD PACKAGE
205381	4850D	2 Bow Frame	Aluminum	1
205382	4851D	3 Bow Frame	Aluminum	1

Bow Slats – Fiberglass

These Trivantage® fiberglass bow slats have a slightly rounded edge, which reduces splinters and prevents damage to fabricated products like boat covers.

ITEM #	COLOR	LENGTH	STANDARD PACKAGE
266361	Natural	6 ft.	10
266362	Natural	6-1/2 ft.	10
266363	Natural	7 ft.	10
266364	Natural	8 ft.	10
266365	Natural	10 ft.	10

Trivantage® is a registered trademark of Glen Raven, Inc.



286199

Boat Top Fittings – Chrome-Plated Zinc Die-Cast – Coaming Side Plate

For use on side of boat when regular hinge cannot be mounted on deck. Furnished with 1/4 inch – 28 x 3/4 inch stainless steel hinge bolt.

ITEM #	STYLE #	STANDARD PACKAGE
286199	898-1839	10



282186

Boat Top Fittings – Chrome-Plated Zinc Die-Cast – Insert Eye End

When inserted, flange of eye end is flush with outside of tubing. Must be secured by means of crimping tool or rivet. For use with Deck Mounting and Angle Hinges.

ITEM #	STYLE #	FOR	STANDARD PACKAGE
282185	1385	3/4 in. OD tube x 0.049 wall	10
282186	1836	7/8 in. OD tube x 0.049 wall	10



Boat Top Fittings – Chrome-Plated Zinc Die-Cast – Slip Fit Eye End

With stainless steel set screw.

282177



282183

ITEM #	STYLE #	FOR	STANDARD PACKAGE
282177	824 HD	7/8 in. OD tube	10
282184	824-1843	7/8 in. OD tube	10
282183	833A-1842	3/4 in. OD tube	10



287890

Boat Top Fittings – Chrome-Plated Zinc Die-Cast – Eye Strap

ITEM #	STYLE #	STANDARD PACKAGE
287890	8816	10



284088

Boat Top Fittings – Chrome-Plated Zinc Die-Cast – Angle Hinge

10° angle, with stainless steel screw.

ITEM #	STYLE #	PROJECTION	STANDARD PACKAGE
284088	887-1841	1 in.	10



284054

Boat Top Fittings – Chrome-Plated Zinc Die-Cast – Deck Hinge

ITEM #	STYLE #	DESCRIPTION	STANDARD PACKAGE
284054	N1846	Angle Deck Hinge – 5° with Quick Release	10



284084

Boat Top Fittings – Chrome-Plated Zinc Die-Cast – Deck Mounting Hinge

Furnished with stainless steel machine screw.

ITEM #	STYLE #	PROJECTION	STANDARD PACKAGE
284084	878 HD	1-1/16 in.	10
284087	877	1-1/16 in.	10



287687

Boat Top Fittings – Chrome-Plated Zinc Die-Cast – Jaw Slide

Equipped with stainless steel set screw and machine screw.



287691



287881

ITEM #	STYLE #	FOR	STANDARD PACKAGE
287686	865	3/4 in. OD tube, 3/8 in. vinyl covered tube	10
287687	856-1838	7/8 in. OD tube	10
287691	856 HD	7/8 in. OD tube	10
287881	86004	7/8 in. OD tube	10



287839

Boat Top Fittings – Chrome-Plated Zinc Die-Cast – Boat Cover Socket

Ideal to keep boat covers from sagging. Use with Trivantage® Fiberglass Bow Slats to support boat cover. Two screw holes drilled for No. 8 screw.

ITEM #	STYLE #	SIZE	STANDARD PACKAGE
287840	740-CR180	3/8 in. height, 1-3/4 in. x 3/8 in. opening, 3-3/8 in. x 3/4 in. base	10
287839	840	1/2 in. height, 1-3/4 in. x 3/8 in. opening, 3-3/8 in. x 7/8 in. base	10

Trivantage® is a registered trademark of Glen Raven, Inc.



249205

Leather Pearl Splits

A sturdy leather fabric that is ideal for marine applications that require extra reinforcement such as cut-outs, patches, etc.

ITEM #	WEIGHT
249205	~4 oz.



207608

Boat Top Fittings – Nickel-Plated Brass – Adjuster Buckle

Single bar buckle to adjust strap.

ITEM #	STYLE #	STANDARD PACKAGE	WEBBING SIZE
207608	100	100	1 in.



287872

Boat Top Fittings – Nickel-Plated Brass – Eye Strap

Style No. 2816 Eye Strap is for fastening No. 142-A Snap Hook to deck. Style No. 2916 Eye Strap is for fastening No. 249-0 Snap Hook to deck.

ITEM #	STYLE #	MATERIAL	STANDARD PACKAGE
287870	2816	Nickel Plated Brass	10
287872	2916	Nickel Plated Brass	10



266682



266684

Boat Top Fittings – Nickel-Plated Brass – Solid Eye Snap Hook

ITEM #	STYLE #	DESCRIPTION	LENGTH	MATERIAL	STANDARD PACKAGE	WEBBING SIZE
266682	249B-0		2-1/8 in.		10	
266684	248B-0	Square Eye		Nickel Plated Brass	10	1 in.

266682 - For use with 2916 Eye Strap.



289639

Boat Top Fittings – Nylon – Bimini Top Ladder Clip

ITEM #	STYLE #	COLOR	SIZE	STANDARD PACKAGE
289599	4330	Black	1 in.	10
289639	4330	Black	7/8 in.	10
289640	4330W	White	1 in.	10
289598	4330W	White	7/8 in.	10



289607

Boat Top Fittings – Nylon – Rigid Support Clip

ITEM #	STYLE #	COLOR	SIZE	STANDARD PACKAGE
289607	21463	Black	7/8 in.	10



289608

Boat Top Fittings – Nylon – Vadney Clip

ITEM #	STYLE #	COLOR	STANDARD PACKAGE
289608	1178120	Black	1



289201

289202



289203

289204

Boat Top Fittings – Nylon – Eye End

ITEM #	STYLE #	COLOR	FOR	STANDARD PACKAGE
289201	7402	White		10
289202	7416	White	3/4 in. OD tube	10
289203	7417	White		10
289204	7419	White	7/8 in. OD tube	10
289251	7402	Black		10
289252	7416	Black	3/4 in. OD tube	10
289253	7417	Black		10
289254	7419	Black	7/8 in. OD tube	10
289255	7419	Natural	7/8 in. OD tube	10



289592

Boat Top Fittings – Nylon – Eye Strap

ITEM #	STYLE #	COLOR	STANDARD PACKAGE
289591	7407	White	10
289592	7407	Black	10



289089

Boat Top Fittings – Nylon – Gasket

Rubber gasket.

ITEM #	STYLE #	COLOR	STANDARD PACKAGE
289089	401-GB	Black	10



289097

Boat Top Fittings – Nylon – Curved Shim

ITEM #	STYLE #	COLOR	STANDARD PACKAGE
289097	401-S-2.36B	Black	10
289098	401-S-2.36	Silver	10



289430

Boat Top Fittings – Nylon – Hinge

ITEM #	STYLE #	DESCRIPTION	COLOR	SIZE	STANDARD PACKAGE
289342	7443B	Concave Hinge Rail	Black	7/8 in.	10
289430	7424P	Knurl Screw	Black	1/4 in. - 20 x 7/8 in.	10
289352	7405	Large Deck Hinge	Black		10
289302	7405	Large Deck Hinge	White		10
289351	7401	Small Deck Hinge	Black		10



289302



289453

Boat Top Fittings – Nylon – Jaw Slide

ITEM #	STYLE #	COLOR	FOR	STANDARD PACKAGE
289451	7406	White	3/4 in. OD Tubing	10
289452	7418	White	7/8 in. OD Tubing	10
289453	7406	Black	3/4 in. OD Tubing	10
289454	7418B	Black	7/8 in. OD Tubing	10
289458	7515	Black	1 in. Square Tubing	10



289454



289458



289362

Boat Top Fittings – Nylon – Lashing Hook

ITEM #	STYLE #	COLOR	STANDARD PACKAGE
289360	7420	White	10
289362	7420	Black	10
289394	7460B	Black	10



289460

Boat Top Fittings – Nylon – Double Wing Windshield Latch

ITEM #	STYLE #	COLOR	STANDARD PACKAGE
289460	7222B	Black	10



289610

Boat Top Fittings – Nylon – Bow Socket

ITEM #	STYLE #	COLOR	STANDARD PACKAGE
289610	7434	Black	10



289618

Boat Top Fittings – Nylon – Side Curtain Spacer

Designed to keep clear vinyl side curtains away from convertible top frames. Eliminates scratching and discoloration of vinyl curtains. Snaps over a 7/8 inch or 1 inch outside diameter tube. No tools required for assembly.

ITEM #	STYLE #	COLOR	FOR	STANDARD PACKAGE
289618	7628	White	7/8 in. OD tube	10
289619	7629	White	1 in.OD tube	10
289620		White	7/8 in. OD tube	10
289628		Gray	7/8 in. OD tube	10



289402

Boat Top Fittings – Nylon – Mounting Plate

ITEM #	STYLE #	DESCRIPTION	COLOR	STANDARD PACKAGE
289402	7415	Slide Mount Plate – 2-Hole	Black	10



289088

Boat Top Fittings – Nylon – Wedge

Converts 90° deck hinges to angle hinges. Install between deck hinge and deck.



289091

ITEM #	STYLE #	DESCRIPTION	COLOR	STANDARD PACKAGE
289088	401-35B	Base Angle Oval Polywedge – 10°	Black	10
289092	401-35N	Base Angle Oval Polywedge – 10°	Natural	10
289091	7530B	Base Angle Rectangular Wedge – 9°	Black	10
289090	7530N	Base Angle Rectangular Wedge – 9°	Natural	10



266343

Slide Track – Aluminum – Track

ITEM #	STYLE #	LENGTH	MATERIAL	STANDARD PACKAGE
266343	6410 TM-5	14 ft.	Anodized Aluminum	14



289551

Slide Track – Nylon – Slides

ITEM #	STYLE #	DESCRIPTION	COLOR	STANDARD PACKAGE
289505	7408	Slide for Deck Hinge	Natural	1
289551	7408	Slide for Deck Hinge	Black	1
289553	7430	Side Mount Slide	Black	1



289102

Slide Track – Nylon – Hinge

ITEM #	STYLE #	DESCRIPTION	COLOR	SIZE	STANDARD PACKAGE
289354	7431	Deck Hinge/ Slide Combination	Black		10

Slide Track – Nylon – Slide Cap

ITEM #	STYLE #	DESCRIPTION	COLOR	STANDARD PACKAGE
289102	7404	Slide Cap Channel Trim End Cap	Black	10
289153	7429	Slide Cap Channel Trim End Insert	Black	10



289371

Slide Track – Nylon – Slide Lock

ITEM #	STYLE #	DESCRIPTION	COLOR	STANDARD PACKAGE
289371	7432	Slide Lock	Black	10



154700

Mooring Pole – Aluminum ‘Thumb Screw’

Designed especially for boat mooring covers, the 730 Mooring Pole adjusts to 70 in. overall and collapsed measures 40-5/8 inch. Has 2-1/2 inch long swaged tip designed for No. 3 Grommet or larger. Top section is 3/4 inch O.D. x .049 wall and bottom section is 7/8 inch O.D. x .042 wall, mill finish, drawn 6063T832 aluminum tubing. Comes with crutch tip bottom to prevent marring of boat floor.

ITEM #	STYLE #	MAXIMUM EXTENSION	STANDARD PACKAGE
154700	730	5 ft. 10 in.	10



205453

Mooring Pole – Aluminum Extension

A medium range, multi-purpose support pole with interchangeable end components. Simply turn the pole extension around for a choice of either plastic injection molded end with snap stud or a molded swaged tip.

ITEM #	STYLE #	DESCRIPTION	EXTENSION BAR THREADED	STANDARD PACKAGE
205453	4848		48 in. to 96 in.	10
205454	3636	Black Crutch Tip	40 in. to 70 in.	25
205458	3636	White Crutch Tip	40 in. to 70 in.	10



205454

Support Pole – Aluminum Extension

A medium range, multi-purpose support pole with interchangeable end components. Simply turn the pole extension around for a choice of either plastic injection molded end with snap stud or a molded swaged tip.

ITEM #	STYLE #	SIZE	STANDARD PACKAGE
205452	X47A-2	47 in.	10
205457	X59A-2TIP	59 in.	10
205459	X70A-2TIP	70 in.	10

Nylon Pole Fittings



ITEM #	STYLE #	DESCRIPTION	COLOR	SIZE	STANDARD PACKAGE
289625	7623	Jointer Section	Black	3/4 in. - 7/8 in.	10
289185	7521B	Jointer Section	Black	7/8 in. - 1 in.	10
289191	PE25	Pole End Insert with Snap	Black	7/8 in.	10
289183	7621	Pole End with Stainless Steel Cap	Black	3/4 in.	10
289180	7610B	Pole Tip	Black	7/8 in.	10
289095	9518	Soft Outside End Cap	Black	7/8 in.	10
289181	7619	Vinyl Foot	Black	3/4 in.	10
289182	7620	Vinyl Foot	Black	7/8 in.	10



Nylon Pole Pads

Non-slip base pole pad.

274823

ITEM #	DESCRIPTION	SIZE	STANDARD PACKAGE
205460	Adjustable	7/8 in.	1
274823		7/8 in.	10



Tip – Rubber

Eliminates damage or wear on fabric end curtains of patio awning where a Tie-Down Bar is used. Slips over ends of pipe used on roller curtains, to prevent end of pipe from chafing side of house. Can also be used on mooring poles to prevent marring boat floor.

274819

ITEM #	STYLE #	DESCRIPTION	COLOR	FOR	STANDARD PACKAGE
476095	18	Tip with Stud	White	3/4 in. tubing	1
274817	17	Tip	Black	5/8 in. tubing, 3/8 in. pipe	10
274819	19	Tip	Black	7/8 in. tubing, 1/2 in. pipe	10
274815	18	Tip	White	3/4 in. tubing	10
274816	17	Tip	White	5/8 in. tubing, 3/8 in. pipe	10
274818	19	Tip	White	7/8 in. tubing, 1/2 in. pipe	10



207620

Boat Top Fittings – Stainless Steel Type 304 – Adjuster Buckle

ITEM #	STYLE #	DESCRIPTION	STANDARD PACKAGE	WEBBING SIZE
207620	300	Adjuster Buckle Single Bar	10	1 in.



260450

Boat Top Fittings – Stainless Steel Type 304 – Dee Ring

ITEM #	STYLE #	DESCRIPTION	SIZE	STANDARD PACKAGE
260450	127-20-70816	Welded	1 in.	10
260456		Welded	1-1/2 in.	10
284235	SS-563-1		1 in.	10



284074

Boat Top Fittings – Stainless Steel Type 304 – Pull Pin

Item No. 284704 – Pull pin with 3/16 inch diameter pin, 1 inch grip and 1 inch ring handle.



284075

Item No. 284075 – Pull pin with 1/4 inch diameter pin, 3/4 inch grip, 1 inch ring handle, and 6 inch nylon-coated, stainless steel lanyard with 1-1/4 inch stainless steel tab.



284075

Item No. 284077 – Pull pin with 1/4 inch diameter flip type pin and 1-1/8 inch ring; pin includes stainless steel wire outer spring guard for flip.



284077

Item No. 284097 – Pull pin with 1/4 inch diameter flip type pin, 1-1/8 inch ring and 6 inch plastic coated, stainless steel lanyard with 1-1/4 inch stainless steel tab; pin includes stainless steel wire outer spring guard for flip.



284097

ITEM #	STYLE #	DESCRIPTION	STANDARD PACKAGE
284074	C3-10R-303	Pull Pin	10
284075	74-7-303	Pull Pin with Lanyard/Tab	10
284077	1815-1	Pull Pin – Flip Type	10
284097		Pull Pin with Lanyard/Tab – Flip Type	10



284060

Boat Top Fittings – Stainless Steel Type 304 – Lift Ring

ITEM #	STYLE #	DESCRIPTION	STANDARD PACKAGE
284060	F16-1812	Flush Mount Lift Ring	10



263930

263914

No. 263917

263915

No. 263918

Boat Top Fittings – Stainless Steel Type 304 – Hinge/Set Screw

ITEM #	STYLE #	DESCRIPTION	SIZE	STANDARD PACKAGE	THREADED FOR SIZE
263930		Cup Point Set Screw	3/16 in.	10	1/4 - 28
263914		Machine Screw for #356/357 Jaw Slides		10	1/4 - 20
263917		Machine Screw for #378/386 Hinge		10	1/4 - 20
263915		Machine Screw for #387 Angle Hinge		10	1/4 - 20
263918		Machine Screw for #398 Side Deck Plate		10	1/4 - 20



266683

Boat Top Fittings – Stainless Steel Type 304 – Snap Hook

ITEM #	STYLE #	DESCRIPTION	LENGTH	MATERIAL	STANDARD PACKAGE	WEBBING SIZE
266683	9905S	Steel Wire Snap	2-1/8 in.	Stainless Steel	100	1 in.



282172



282132



282173



282133



284257

Boat Top Fittings – Stainless Steel Type 316 – Eye End

ITEM #	STYLE #	DESCRIPTION	FOR	STANDARD PACKAGE
282172	324	Eye End	7/8 in. OD tube	10
282132	324-88313	Eye End	7/8 in. OD tube	10
282173	338	Eye End	1 in. OD tube	10
282133	338-88314	Eye End	1 in. OD tube	10
284257	88328	Eye End with Double Set Screw	1-1/4 in. OD tube	10



282210



282211



282214

Boat Top Fittings – Stainless Steel Type 316 – Ball Eye End

ITEM #	STYLE #	DESCRIPTION	FOR	STANDARD PACKAGE
282209	F11-0177A	Ball Eye End For Pop Rivet	7/8 in. OD tube	10
282210	F11-0177S	Ball Eye End For Set Screw	7/8 in. OD tube	10
282211	F11-0180S	Ball Eye End – 90°	7/8 in. OD tube	10
282214	F12-0181S	Ball Eye End	1 in. OD tube	10



282171



282175

Boat Top Fittings – Stainless Steel Type 316 – Counter Bore Eye End

ITEM #	STYLE #	DESCRIPTION	FOR	STANDARD PACKAGE
282171	324	Counter Bore Eye End without Set Screw	7/8 in. OD tube	10
282175	333	Counter Bore Eye End without Set Screw	3/4 in. OD tube	10

Boat Top Fittings – Stainless Steel Type 316 – Humpback Eye End



282176



282187



282140

ITEM #	STYLE #	DESCRIPTION	FOR	STANDARD PACKAGE
282176	324	Humpback Eye End	7/8 in. OD tube	10
282179	338v	Humpback Eye End	1 in. OD tube	10
282187	8208	Humpback Eye End with 2 Double set Screws	1-1/4 in. OD tube	10
282139	88396	Humpback Eye End with Double Set Screw	7/8 in. OD tube	10
282140	88397	Humpback Eye End with Double Set Screw	1 in. OD tube	10

Boat Top Fittings – Stainless Steel Type 316 – Insert Eye End



282178

ITEM #	STYLE #	DESCRIPTION	FOR	STANDARD PACKAGE
282178	324I	Eye End Insert	7/8 in. OD tube	10
282180	338I	Eye End Insert	1 in. OD tube	10

Boat Top Fittings – Stainless Steel Type 316 – Eye Strap



287875



284276



284216



287874

ITEM #	STYLE #	DESCRIPTION	DIAMETER HOLE	DRILLED FOR	HEIGHT	LENGTH	STANDARD PACKAGE
287875	3816	Eye Strap	0.208/0.198 in. 82° countersink				10
284276	88545	Eye Strap		#10 screw	5/8 in.	1-7/8 in.	10
284216	88542	Formed Eye Strap		#8 screw	1/2 in.	1-7/8 in.	10
287874	3716	Heavy Duty Eye Strap	0.200 in.				10

Boat Top Fittings – Stainless Steel Type 316 – Grab Handles



284262

For use with 7/8" stainless steel tubing. Comes packaged with 2 handles per package.

ITEM #	STYLE #	DESCRIPTION	FOR	STANDARD PACKAGE
284262	9114665	Bimini/Dodger Adjustable Grab Handles	7/8 in. tubing	Pack of 2

Boat Top Fittings – Stainless Steel Type 316 – Hinge/Set Screw

ITEM#	STYLE#	DESCRIPTION	SIZE	STANDARD PACKAGE	THREADED FOR SIZE
284282	88338	Cone Point Allen Drive Set Screw	3/16 in.	100	1/4 28

Boat Top Fittings – Stainless Steel Type 316 – Angle Hinge



ITEM #	STYLE #	DESCRIPTION	DRILLED FOR	PANHEAD SCREW	PROJECTION	SIZE	STANDARD PACKAGE
284207	230	Angle Hinge with Screw	#10 screw	1/4 - 20		3/4 in. x 2 in.	10
284073	387QR	Angle Hinge without Pin – 10° (1/4 in. drilled hole)	#10 screw	1/4 - 20	1 in.	7/8 in. x 2 in.	10
284208	233	Angle Hinge without Screw (1/4 in. drilled hole)	#10 screw			3/4 in. x 2 in.	10
284071	387	Angle Hinge – 10°	#10 screw	1/4 - 20	1 in.	7/8 in. x 2 in.	10
284078	886A	Universal Deck Hinge – 45°	1/4 in. screws	M6 x 1	1 in.	1 in. x 2-1/8 in.	10
284076	886	Universal Deck Hinge – 90°	1/4 in. screws	M6 x 1	7/8 in.	1 in. x 2-1/8 in.	10

Boat Top Fittings – Stainless Steel Type 316 – Concave Hinge



ITEM #	STYLE #	DESCRIPTION	DRILLED FOR	PROJECTION	SIZE	STANDARD PACKAGE
284086	386R	Concave Hinge	#10 screw	1-1/4 in.	3/4 in. x 2-7/16 in.	10
284209	88321	Concave Hinge with 1/4 in. Bolt	#10 screw	1-3/8 in.	7/8 in. x 2 in.	10
284210	88321N	Concave Hinge without Pin	#10 screw	1-3/8 in.	7/8 in. x 2 in.	10

Boat Top Fittings – Stainless Steel Type 316 – Socket



ITEM #	STYLE #	DESCRIPTION	STANDARD PACKAGE
284124	F13-0242/244BN	Concave Hinge Socket with Lanyard	10
284120	F13-0241/244BN	Deck Hinge Socket with Lanyard	10
284123	F13-0301/244BN	Hinge Socket with Lanyard	10
284132	F13-1095P	Socket Hinge with D-Ring – Port	10
284133	F13-1095S	Socket Hinge with D-Ring – Starboard	10

Boat Top Fittings – Stainless Steel Type 316 – Deck Hinge



ITEM #	STYLE #	DESCRIPTION	DRILLED FOR	PANHEAD SCREW	PROJECTION	SIZE	STANDARD PACKAGE
284083	401	Bimini Quick Release Deck Hinge	#10 screw		1 in.	1-3/16 in. x 3-1/2 in.	10
284102	415	Bimini Quick Release Deck Hinge			1.3 in.	3.6 in.	10
284130	F13-1085P	Deck Hinge with D-Ring Port					10
284131	F13-1085S	Deck Hinge with D-Ring Starboard					10
284082	378QR	Deck Hinge without Pin (1/4 in. drilled hole)	#10 screw		1-1/8 in.	7/8 in. x 2 in.	10
282134	88320N	Deck Hinge without Pin – 90° (1/4 in. drilled hole)	#10 screw			3/4 in. x 2 in.	10
284206	88320	Deck Hinge – 90°	#10 screw	1/4 - 20		3/4 in. x 2 in.	10
284059		Heavy Duty Adjustable Deck Hinge – 90°	1/4-20 screw		1-1/2 in.		10
284259	88320-3	High Profile Deck Hinge	#10 screw	5/16 in. flush head screw	3 in.	1 in. x 2 in.	10
284070	378	Straight Deck Hinge	#10 screw	1/4 - 20	1-1/8 in.	7/8 in. x 2 in.	10

Boat Top Fittings – Stainless Steel Type 316 – Post



ITEM #	STYLE #	DESCRIPTION	SIZE	STANDARD PACKAGE
284091	401-P-07	Bimini Quick Release Deck Hinge Post	5/8 in.	10
284109	401-P-07	Bimini Quick Release Deck Hinge Post	1/2 in.	10

Boat Top Fittings – Stainless Steel Type 316 – Locking Rail Hinge



ITEM #	STYLE #	DESCRIPTION	FOR	STANDARD PACKAGE
284265	9027204	Locking Rail Hinge with Quick Release Pin	7/8 in. OD tube	10
284270	9027202	Locking Rail Hinge with Quick Release Pin	1 in. OD tube	10

Boat Top Fittings – Stainless Steel Type 316 – Side Deck Plate Hinge



ITEM #	STYLE #	DESCRIPTION	BOLT SIZE	DRILLED FOR	SIZE	STANDARD PACKAGE
286170	398	Side Deck Plate – 2-Hole	1/4 in. - 20	#10 screw	7/8 in. x 2 in.	10
286172	388	Side Deck Plate – 4-Hole	1/4 in. - 20 Phillips			100
286173	388	Side Deck Plate – 4-Hole	5/16 in. Hex			100



Boat Top Fittings – Stainless Steel Type 316 – Side Mount Hinge

ITEM #	DESCRIPTION	FOR	STANDARD PACKAGE
289324	Sliding Side Mount Hinge	1-1/4 in. OD tube	10
289325	Sliding Side Mount Hinge	7/8 in. OD tube	10
289326	Sliding Side Mount Hinge	1 in. OD tube	10
289323	Split Side Mount Hinge	1-1/4 in. OD tube	10
289328	Split Side Mount Hinge	1 in. OD tube	12



Boat Top Fittings – Stainless Steel Type 316 – Lashing Hook

With two 3/16 inch holes.

ITEM #	STYLE #	DESCRIPTION	SIZE	STANDARD PACKAGE
287876	89010	Lashing Hook	1 in. x 1-1/4 in.	10



Boat Top Fittings – Stainless Steel Type 316 – Double-Sided Jaw Slide



ITEM #	STYLE #	DESCRIPTION	FOR	STANDARD PACKAGE
287648	G6975	Double Side Jaw Slide with Swivel Hinge	1 in. OD tube	1
287655	88317-2	Double Sided Jaw Slide	1 in. OD tube	10



Boat Top Fittings – Stainless Steel Type 316 – Hinged Jaw Slide



ITEM #	STYLE #	DESCRIPTION	FOR	STANDARD PACKAGE
284267	8731442	Hinged Jaw Slide with Allen Set Screw	7/8 in. OD tube	10
284268	8731443	Hinged Jaw Slide with Allen Set Screw	1 in. OD tube	10
284269	8731447	Hinged Jaw Slide with Allen Set Screw	1-1/4 in. OD tube	10



Boat Top Fittings – Stainless Steel Type 316 – Rail



ITEM #	DESCRIPTION	FOR	STANDARD PACKAGE
226947	Locking Hinged Jaw Slide	1 in. OD tube	10
226948	Locking Hinged Jaw Slide	1-1/4" OD tube	10

Boat Top Fittings – Stainless Steel Type 316 – Humpback Jaw Slide



282137



282138



287657



287659

ITEM #	STYLE #	DESCRIPTION	FOR	STANDARD PACKAGE
287660	8211	Humpback Jaw Slide with 2 Set Screws	1-1/4 in. OD tube	10
282137	88398	Humpback Jaw Slide with 2 Set Screws	7/8 in. OD tube	10
282138	88399	Humpback Jaw Slide with 2 Set Screws	1 in. OD tube	10
287657	356	Humpback Jaw Slide	7/8 in. OD tube	10
287659	368	Humpback Jaw Slide	1 in. OD tube	10

Boat Top Fittings – Stainless Steel Type 316 – Jaw Slide



287651



287652



287653



282135



282136

ITEM #	STYLE #	DESCRIPTION	FOR	PANHEAD SCREW	STANDARD PACKAGE
287651	356	Counter Bore Jaw Slide without Set Screw	7/8 in. OD tube		10
287652	356	Jaw Slide with 1/4-28 Set Screw	7/8 in. OD tube	1/4 - 20	10
287653	368	Jaw Slide with 1/4-28 Set Screw	1 in. OD tube	1/4 - 20	10
282135	356-88316	Jaw Slide without Set Screw	7/8 in. OD tube	1/4 - 20	10
282136	356-88317	Jaw Slide without Set Screw	1 in. OD tube	1/4 - 20	10

Boat Top Fittings – Stainless Steel Type 316 – Heavy-Duty Jaw Slide



284258

ITEM #	STYLE #	DESCRIPTION	FOR	STANDARD PACKAGE
284258	88329	Heavy Duty Jaw Slide with 2 Set Screws	1-1/4 in. OD tube	10

Boat Top Fittings – Stainless Steel Type 316 – Jaw Slide For Pop Rivet



284255

ITEM #	STYLE #	DESCRIPTION	FOR	STANDARD PACKAGE
284255	F11-1001	Jaw Slide Socket For Pop Rivet	7/8 in. OD tube	10

Boat Top Fittings – Stainless Steel Type 316 – Socket Jaw Slide



287635



287636

ITEM #	STYLE #	DESCRIPTION	FOR	STANDARD PACKAGE
287635	F11-1001AS	Jaw Slide Socket with Set Screw	7/8 in. OD tube	10
287636	F12-0300S	Jaw Slide Socket with Set Screw	1 in. OD tube	10



Boat Top Fittings – Stainless Steel Type 316 – Adjuster Buckle

ITEM #	STYLE #	DESCRIPTION	FOR	STANDARD PACKAGE
284215	9114706	Web Adjuster Buckle with Recessed Base	1 in. OD tube	10



Boat Top Fittings – Stainless Steel Type 316 – Pull Pin

ITEM #	STYLE #	DESCRIPTION	STANDARD PACKAGE
284126	F13-0244BN	Pull Pin with Pull Knob and Lanyard	10



Boat Top Fittings – Stainless Steel Type 316 – Quick Release Pin

ITEM #	STYLE #	DESCRIPTION	STANDARD PACKAGE
284217	88546	Quick Release Pin (1/4 in. diameter, 7/8 in. grip)	10
284218	88547	Quick Release Pin (1/4 in. diameter, 7/8 in. grip) w/ Tab and 6" Nylon-Coated Stainless Steel Cable	10
284220	88551	Quick Release Pin (1/4 in. diameter, 1 in. grip) w/ DCAM-S Ring	10
284221	88548	Quick Release Pin (1/4 in. diameter, 3/4 in. grip) w/ DCAM-S Ring and 6" Nylon-Coated Cable	10



Boat Top Fittings – Stainless Steel Type 316 – Push Button

ITEM #	STYLE #	DESCRIPTION	STANDARD PACKAGE
284203	89008	Push Button	10

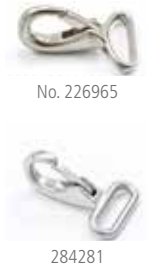

Boat Top Fittings – Stainless Steel Type 316 – Snap Hook

ITEM #	STYLE #	DESCRIPTION	FOR	LENGTH	STANDARD PACKAGE	WEBBING SIZE
226965		Fast Eye Heavy Duty Snap Hook	1 in. OD tube	2 in.	10	1 in.
266687	24955-0	Snap	3/8 in. OD tube	2-1/8 in.	10	3/8 in.
284281	8928263	Heavy Duty Snap Hook	1 in. OD tube		10	



Boat Top Fittings – Stainless Steel Type 316 – Side Mount with Concave Base

ITEM #	DESCRIPTION	STANDARD PACKAGE
226940	Side Mount – 90°	10
226941	Side Mount – 75°	10



226929

Boat Top Fittings – Stainless Steel Type 316 – Plug

ITEM #	STYLE #	DESCRIPTION	FOR	STANDARD PACKAGE
226929	88303	Bullet End Plug	7/8 in. OD tube	10



282216

Boat Top Fittings – Stainless Steel Type 316 – Elbow Eye End

ITEM #	STYLE #	DESCRIPTION	FOR	STANDARD PACKAGE
282216	88310	Elbow – 90°	1 in. OD tube	10



226920

Boat Top Fittings – Stainless Steel Type 316 – Slip Tee

ITEM #	DESCRIPTION	FOR	STANDARD PACKAGE
226920	Slip Tee – 90°	7/8 in. OD tube	10
226922	Slip Tee – 90°	1 in. OD tube	10



226922

Boat Top Fittings – Stainless Steel Type 316 – Hinged Tee

ITEM #	DESCRIPTION	FOR	STANDARD PACKAGE
226921	Hinged Slip Tee – 90°	7/8 in. OD tube	10



208340

Boat Top Fittings – Stainless Steel – Push Button

ITEM #	STYLE #	MATERIAL	SIZE	STANDARD PACKAGE
208340	II-132	Stainless Steel	1/4 in.	10



208340

Boat Top Fittings – Stainless Steel – Bolster Clip

ITEM #	STYLE #	MATERIAL	SIZE	STANDARD PACKAGE
255216	F16-0094	Stainless Steel	3 in.	1



255216

Tubing – Marine – Stainless Steel Type 304

For convertible boat tops and boat railings. Available from 7/8 inch to 1-1/4 inch O.D. with 16 and 18 gauge wall thicknesses. This tubing is tig welded, polished, buffed and paper sleeved. Sold in full lengths only.

ITEM #	GAUGE	LENGTH	OUTSIDE DIAMETER	PUT UP	STANDARD PACKAGE	WEIGHT PER FOOT
275768	16	20 ft.	1 in.	300 ft.	20	0.6452 lbs.
275765	16	24 ft.	1 in.	360 ft.	24	0.6452 lbs.
275769	16	24 ft.	1-1/4 in.	216 ft.	24	0.8174 lbs.
275759	16	24 ft.	7/8 in.	480 ft.	24	0.5591 lbs.
275779	18	24 ft.	1 in.	360 ft.	24	0.5290 lbs.
275761	18	20 ft.	7/8 in.	400 ft.	20	0.4593 lbs.
275763	18	24 ft.	7/8 in.	480 ft.	24	0.4593 lbs.

Tubing – Marine – Stainless Steel Type 316

For convertible boat tops and boat railings. Available from 7/8 inch to 1-1/4 inch O.D. with 16 and 18 gauge wall thicknesses. This tubing is tig welded, polished, buffed and paper sleeved. Sold in full lengths only.

ITEM #	GAUGE	LENGTH	OUTSIDE DIAMETER	PUT UP	STANDARD PACKAGE	WEIGHT PER FOOT
275790	16	20 ft.	1 in.	300 ft.	20	0.6452 lbs.
275791	16	24 ft.	1 in.	360 ft.	24	0.6452 lbs.
275797	16	24 ft.	1-1/4 in.	216 ft.	24	0.8174



578164

Keder – Roller Track

Aluminum.

ITEM #	STYLE #	DEGREE OF CHANNEL	LENGTH	STANDARD PACKAGE
578164	48.6025.31.05	180°	16.4 ft.	1
578166	48.5524.31.05	90°	16.4 ft.	1
578167	48.5524.31.025	180°	8.2 ft.	1



578160



578161

Crocodile Hanger®

Crocodile Hangers combine the strong sliding and movement features of Ball Hooks with the durability of Bar Sliders. The composition and design allows excellent durability for use in a range of environments.

ITEM #	STYLE #	DESCRIPTION	SIZE	STANDARD PACKAGE
578160	35.0927.41	Ball Hook	9 mm	100
578161	35.2727.41	Calott Slider	9 mm	100
578162	35.8027.41.21	Keder Track Roller with Screw Caps	9 mm	100
578163	25.8309.18	Stainless Steel Screw		100



578162



578163

Crocodile Hanger® is a registered trademark of American Keder, Inc.



578104

Keder – Marine

Keder is designed for use in tensile structures where strength and resistance to the elements are critical. Made from a unique, heavy-duty polyester fabric welded to a solid PVC cord. It is easy to sew and won't tear out. It easily slides through Flex-A-Rail and various PVC and aluminum tracks.

ITEM #	STYLE #	DESCRIPTION	COLOR	PUT UP	SIZE
578131			Black	109 yd.	7.5 mm
578134	C7420		Black	109 yd.	8.5 mm x 20 mm
578130			White	109 yd.	7.5 mm
578107	11.0830.11		White	110 yd.	8.5 mm
578133	C7420		White	109 yd.	8.5 mm x 20 mm
578103	12.0830.11	Double Tongue	White	110 yd.	8.5 mm
578111	13.0722.19	Welded Tongue	Black	110 yd.	7.5 mm
578105	13.0820.19	Welded Tongue	Black	110 yd.	8.5 mm
578106	13.0720.11	Welded Tongue	White	110 yd.	7.5 mm
578104	13.0820.11	Welded Tongue	White	110 yd.	8.5 mm

Keder – Tent

Keder is designed specifically for use in outdoor tensile structures where strength and resistance to the elements are critical. Made from a unique, heavy-duty polyester fabric welded to a solid PVC cord. It is easy to sew and won't tear out.

ITEM #	COLOR	PUT UP	SIZE
578137	Panama with Blackout	218 yd.	11 mm x 40 mm
578136	White with Blackout	218 yd.	13 mm x 40 mm
578135	White	218 yd.	13 mm x 40 mm



251028



R1062

251051

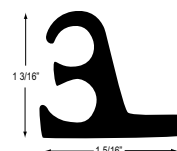

R1234

251058

Track – PVC

This rigid PVC molding is UV resistant, non-corrosive, non-rusting and can be used in or on salt water. Can be shaped very easily.

Will cold crack under extreme cold conditions.

ITEM #	STYLE #	DESCRIPTION	COLOR	DEGREE OF CHANNEL	FLANGE SIZE	LENGTH	STANDARD PACKAGE	WEIGHT PER FOOT
251026	1445		White	90°	0.610 in.	18 ft.	270	0.15 lbs.
251028	333		White	90°	0.610 in.	8 ft.	120	0.15 lbs.
251051	R1062		White	45°	0.500 in.	8 ft.	8	0.185 lbs.
251052	R1062		White	45°	0.500 in.	14 ft.	14	0.185 lbs.
251057	R1338	Double Ceiling Molding	White			8 ft.	80	0.2451 lbs.
251058	R1234	Double Wall Molding	White		0.500 in.	8 ft.	8	0.325 lbs.



578060

Track – Costa Track®

Costa Track is a center mount track with a heavy-duty PVC profile that maximizes load capability for large covers, bimini and track-to-track enclosures. It is pre-drilled every four inches, and can be heat-formed to most radiuses. Its large channel opening allows use of stainless steel #6 oval head screws for more secure attachment. The deep screw trough base design allows for use of 8.5mm Keder with sufficient clearance of screw heads.

Costa Track is designed with a pocketed underside to accommodate Double-Faced Foam Pressure Sensitive Tape, which is used to set and seal the track to the mounting surface before being secured with the screws.

ITEM #	DESCRIPTION	COLOR	LENGTH	STANDARD PACKAGE	TYPE
578060	UVR Heavy Duty Vinyl	White	8 ft.	8	Flat
578061	UVR Heavy Duty Vinyl	White	16 ft.	16	Flat
578063	UVR Heavy Duty Vinyl	Off-White	16 ft.	16	Flat
578066	UVR Heavy Duty Vinyl	Off-White	16 ft.	16	Contoured
578067	UVR Heavy Duty Vinyl	White	16 ft.	16	Contoured

Costa Track® is a registered trademark of Costa Marine Canvas and Enclosures.



284246

Track – Costa Track® End Cap

This polished end cap gives a professional finish to your Costa Track® track installation while protecting the PVC opening from being "burned out" by taking the keder in and out of the track. Not applicable for contoured Costa Track.

ITEM #	STYLE #	MATERIAL	STANDARD PACKAGE
284246	501354800	Stainless Steel Type 316	1



578069

Track – Three Channel – PVC

This white PVC Three Channel Track is designed to extend double track capabilities to locations where fasteners are not available, or when track cannot be mounted to a boat, such as the crown on a hardtop, and cross sections of fabric or stainless steel rods. This track can be used with Trivantage® 8.5 mm Keder.

ITEM #	STYLE #	COLOR	LENGTH	PUT UP	STANDARD PACKAGE
578069	0773	White	12 ft.	12 ft.	12

Trivantage® is a registered trademark of Glen Raven, Inc.

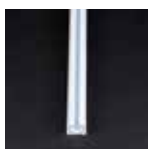

578019

Track – Flex-A-Rail

Flex-A-Rail provides quick and easy installation of boat windshields, tops, covers and curtains. It can also be used to mount awnings and truck covers.

A PVC extrusion, Flex-A-Rail is non-corrosive and can be run around tight corners without the use of crimping tools. Only small amounts of heat are needed to bend or straighten. Pre-drill holes just slightly larger than the shank of the screw. Holes should be 2 inches to 2-1/2 inches apart for tight radiuses, and 4 inches to 8 inches apart depending upon the configuration of the mounting surface.

ITEM #	STYLE #	DESCRIPTION	COLOR	LENGTH	STANDARD PACKAGE
578019	180-2-W	UVR Vinyl	White	180 in.	50
578018	90-2-B	UVR	Black	90 in.	100
578017	90-2-W	UVR Vinyl	White	90 in.	100



265452

265453



265450

265454

Track – Trim Screws

For use with PVC and aluminum track.

ITEM #	DESCRIPTION	MATERIAL	SIZE	STANDARD PACKAGE
265452	Hex Driver for Trim Screw (265453)			1
265453	Hex Head Trim Screw	Stainless Steel	#6 x 3/4" x #4 head, #0 square drive	1
265450	Phillips Head Trim Screw	Stainless Steel	#6 x 3/4" x #4 pan head	1
265454	Phillips Head Trim Screw	Stainless Steel	#6 x 5/8" x #4 head	1



Track – Headliner

Headliner track is an efficient and cost effective way to install or replace headliners. With Headliner Track, there is no need for staplers or trim strips, and fabricators no longer need to work in enclosed spaces using toxic adhesives and heavy foam backed fabrics.

Headliner Track also makes it possible to replace damaged headliners or work on parts of the boat which were previously not accessible without damaging or rebuilding the entire headliner. Headliner Track allows you to simply pull the fabric out of the track and put it back when the work is done.

Headliner Track is available in two profiles. The Perimeter track is used for the outside edge of a cabin ceiling and the Mid-Wall track is used as an intermediate attachment of the headliner fabric's seams and centerlines. Attached with screws, Headliner Track can be easily mitered for clean corners or slotted for gradual bends and curves.

ITEM #	DESCRIPTION	LENGTH	STANDARD PACKAGE
578070	Perimeter Track	18 ft.	18
578071	Mid-Wall Track	18 ft.	18



275454

Track – Headliner – Tools

Four custom Headliner track tools make fabric installation a snap. Each tool is lightweight and ergonomically designed with textured, non-slip surfaces. Tools include a 45-degree angle short run tool for tight spaces at close angles; a curved edge tool and straight edge tool for straight runs of short distance; and a nine-inch pizza cutter for long runs of either the Perimeter or Mid-Wall Track.



275455

ITEM #	DESCRIPTION	STANDARD PACKAGE
275457	Bend Tool – 45°	1
275456	Curved Edge Tool	1
275454	Pizza Cutter Tool	1
275455	Straight Edge Tool	1



277543

Boat Vent 3

Boat Vent 3 is an improved version of Boat Vent II, which made its name in the marine industry by preventing the growth of mold and mildew on covered boats. Made from a high UV-inhibited plastic, improvements include 40% more venting, an overhanging top to deter moisture, 30 washer teeth for better grip and an ergonomic reversible nut for easy installation.

ITEM #	COLOR	STANDARD PACKAGE
277543	Black	1



277541

Boat Vent II

A plastic cover support and venting device for use with 3/4 inch or 7/8 inch mooring poles. Designed to distribute a greater volume of exhaust air while closing the top-to-bottom gap that keeps rain out. Suitable for all types of fabric. Unique design eliminates the need for screws, saving time.

ITEM #	COLOR	STANDARD PACKAGE
277541	Black	1



277540

Boat Vent Circle Cutter

Convenient circle cutter allows a hole to be cut in a matter of seconds, for quick and easy installation of the Boat Vent device into fabric. Simply place the cutter in position on the canvas where your Boat Vent is going to sit, press down, and rotate the handle clockwise. One complete revolution provides the perfect 2-1/4" hole for Boat Vent II or a 2-4/5" hole for Boat Vent 3. Using the circle cutter will save time and prevent costly mistakes. The one-of-a-kind device guarantees cutting at least 2,500 holes without dulling. You can use this circle cutter with Boat Vent II or Boat Vent 3 just by switching the blade around.

ITEM #	DESCRIPTION	STANDARD PACKAGE
277540	Boat Vent Circle Cutter	1
277542	Boat Vent Circle Cutter Replacement Blade	1



Vent-Sol-Air™

Vent-Sol-Air uses a solar-powered fan to circulate air under tented boat covers, which fights mold and mildew, and maintains the appearance of a boat's interior.

Vent-Sol-Air mounts to the pole of tented boat covers and installs in minutes. Its sealed, water-resistant design is constructed of tough-plastic for marine-grade durability. Vent-Sol-Air taps the natural power of the sun without using batteries or power cords.



277550

ITEM #	STANDARD PACKAGE
277550	1



Ventilator – Airlette®

Installs in seconds without the aid of hardware or adhesives, by “snapping” into place with an assured water-tight seal. The Airlette Ventilator automatically self-adjusts to fit any material up to 1/8 inch thick. Its hood rotates 360° and can be detached for easy storage.

277501

ITEM #	STYLE #	COLOR	STANDARD PACKAGE
277501	BSA-2	White	1

Airlette® is a registered trademark of Airlette Manufacturing Corporation.



Ventilator – Vent-Aire®

Vent-Aire Vents prevent dry-rot, condensation, mildew and rust. Made of tough, pliable plastic, which snaps back without damage after being bent, folded or flattened. Special hood design ensures that vent will remain open regardless of how cover material is folded.

277630



277610

ITEM #	STYLE #	COLOR	SIZE	STANDARD PACKAGE
277662	63	Black	1-1/2 in. (H) x 5 in. (W) x 6-1/8 in. (L)	1
277660	63	Natural	1-1/2 in. (H) x 5 in. (W) x 6-1/8 in. (L)	1
277630	62	Natural	2 in. (H) x 6-21/32 in. (W) x 6-1/8 in. (L)	1
277610	61	Natural	3 in. (H) x 10 in. (W) x 9 in. (L)	1

Vent-Aire® is a registered trademark of Kaybob Products Co.



HANGTYTE Boat Cover System

An alternative to pole systems, HANGTYTE is a boat cover suspension device that works with all covers. Simple setup. Easy operation.

274811

ITEM #	STYLE #	STANDARD PACKAGE
274811	60901-0000	1



251913

Needle – Sail

ITEM #	STYLE #	FINISH	LENGTH	MATERIAL	STANDARD PACKAGE	TYPE
251916	16	Nickel Plated	2-3/8 in.	Steel	25	Standard
251913	13	Nickel Plated	3 in.	Steel	1	Standard
251706	501	Nickel Plated	6 in.	Steel	1	Curved



254501

Sailmaker's Palm

Riveted sailmaker's palm with rawhide covered thimble.

ITEM #	STYLE #	STANDARD PACKAGE
254501	1	1



254710

Pencil – Fabric Marking

For clear, easy marking of fabrics in the cutting room. Trivantage® offers special pencils with either black, white or yellow lead. Yellow pencils can be wiped off vinyls but are difficult to remove from woven textiles. Black pencils can be used on white fabrics of any type and can be erased or wiped off easily. White pencils are also known as a "spit pencils."

ITEM #	DESCRIPTION	FOR	STANDARD PACKAGE
254711	Black Lead	White fabrics (any type)	72 pencils/box
254706	White Hex Untipped Projection Lead	Clear vinyl, vinyl laminates, vinyl coated polyester and nylon	144 pencils/box
254709	White Lead 1256 "Spit Pencil"	Vinyl, acrylic and woven fabrics	72 pencils/box
254710	Yellow Lead	Vinyl and acrylic fabrics	72 pencils/box

Trivantage® is a registered trademark of Glen Raven, Inc.



255208

Pins – T

Used to secure fabric and make pattern before sewing. A very helpful aid when doing complex custom work, such as a boat top.

ITEM #	STYLE #	LENGTH	MATERIAL	PUT UP	STANDARD PACKAGE
255208	32	2 in.	Steel	1/2 lb. box	1 pound box



255215

Pins – Upholstery

ITEM #	STYLE #	MATERIAL	SIZE	STANDARD PACKAGE
255215	190	Steel	3 in.	1 gross
255214	190	Steel	4 in.	1 gross



214296

Spring Clip – Stainless Steel

Used to carry hand tools.

ITEM #	STYLE #	SIZE	STANDARD PACKAGE
214296	301	0.020 in. x 7/8 in. x 3-3/8 in.	1000



200795

Anchor – Pool Cover

The No. 50 deluxe brass anchor remains flush with the pool deck when not in use, and is highly corrosion resistant. It allows the cover to be easily and securely installed by unscrewing the bolt to receive “S” hooks on a rubber tie, a rubber tie hole, or the rounded ring end of the stainless steel spring. There are no threads to strip at the top of the bolt.

For use with Spring – Pool Cover (Item no. 200797).

ITEM #	STYLE #	DESCRIPTION	MATERIAL	STANDARD PACKAGE
200795	50	Pool Anchor	Brass	1



200797

Spring – Pool Cover

ITEM #	LENGTH	MATERIAL	STANDARD PACKAGE
200797	7.5 in.	Stainless Steel Type 304	1
273795	8 in.	Stainless Steel	1



274511

Ties – Cable

Specially treated for outdoor exposure, these nylon cable ties are designed to allow uniform tightening. Plus, they require less time than traditional lacing cord. These ties are an ideal solution for a professional appearance at a low cost.

ITEM #	STYLE #	COLOR	LENGTH	STANDARD PACKAGE
274511	T50ROM4	Black	8 in.	1000



274515

Ties – Awning

These aluminum ties are flexible and very easy to use. Will not rust or stain. Can be reused.

ITEM #	STYLE #	LENGTH	STANDARD PACKAGE
274515	5	5 in.	200



239401

Hook – Tarp Binding

Cold drawn steel with zinc-plated finish, designed primarily to hold tarp ropes securely on truck bodies. Can be used in any industry where ropes are used, and where rope must be held tight.

ITEM #	STYLE #	DESCRIPTION	DIAMETER HOLE	HOOK OPENING	LENGTH	STANDARD PACKAGE	WIRE DIAMETER
239402	12010	Hook No. 3	3/16 in.	5/8 in.	2 in.	100	0.250 in.
239401	12011	Hook No. 5	1/4 in.	1 in.	3-3/4 in.	100	0.365 in.
239452	12009	Hook No. 52C	3/16 in.	7/16 in.	1-1/2 in.	100	0.192 in.



226010



226002

Screw Eye

Zinc-plated finish – with sharp gimlet points for quick starting.



226008

ITEM #	STYLE #	INSIDE DIAMETER EYE	LENGTH	LENGTH SHANK	STANDARD PACKAGE	WIRE DIAMETER
226010	10	13/32 in.	1-3/8 in.	11/16 in.	100	0.135 in.
226002	2	23/32 in.	2-5/8 in.	1-15/32 in.	50	0.263 in.
226008	8	15/32 in.	1-5/8 in.	13/16 in.	100	0.162 in.



Screw Eye – Long Shank

Zinc-plated. For fastening through wood shingles.

ITEM #	STYLE #	INSIDE DIAMETER EYE	LENGTH	LENGTH SHANK	STANDARD PACKAGE
226085	8-1/2	1/2 in.	2-5/16 in.	1-3/8 in.	100



Screw Eye – Open Eye

Zinc-plated finish with sharp gimlet points for starting.

ITEM #	STYLE #	INSIDE DIAMETER EYE	LENGTH	LENGTH SHANK	STANDARD PACKAGE
226108	8	1/2 in.	1-5/8 in.	13/16 in.	100



O Ring

ITEM #	DIAMETER OF STOCK	FINISH	GAUGE	INSIDE DIAMETER OF RING	MATERIAL	STANDARD PACKAGE
260902	0.177	Chrome Plated	9	1 in.	Zinc Die-Cast	500
260903	3/32 in.		13	3/8 in.	Zinc Die-Cast	1000
260905	3/32 in.	Nickel Plated	12	5/8 in.	Steel	500
260906	1/8 in.		11	3/4 in.	Zinc Die-Cast	500
260920		Nickel Plated			Steel (Welded)	100
261004	1-1/2 in.	Cadmium	3	1-1/2 in.	Steel	750
261005	1-3/64 in.	Cadmium	6	1-1/4 in.	Steel	100
261007	11/32 in.	Cadmium	0	1-3/4 in.	Steel	100
261008	11/32 in.	Cadmium	0	2 in.	Steel	100
261009	3/8 in.	Cadmium	000	2-1/4 in.	Steel	100
261010	3/8 in.	Cadmium	000	2-1/2 in.	Steel	100
261011	3/8 in.	Cadmium	000	2-3/4 in.	Steel	100
261012	3/8 in.	Cadmium	000	3 in.	Steel	50
261102	0.177 in.			1 in.	Type 316 Stainless Steel	100



Spring – Snap Link

Zinc-plated steel.

ITEM #	STYLE #	DESCRIPTION	STANDARD PACKAGE
266677	245M-50M	1.97 in. x 5 mm wire	100



269115

Goldline® EPDM Tie-Down And Tarp Strap

Straps reinforced at hook ends. Hooks are 2-1/2 inch and where included come in a quantity of 2.

To determine strap size, let maximum stretch length, below, be your guide. For example, if distance between tarp grommet and trailer tie-down bar is 24 inch, order a 15 inch strap which provides a maximum 25 inch stretch length. If distance is 27 inch, order a 21 inch strap with maximum 34 inch stretch length.

Where hooks are inserted, or included loose, we supply two hooks per strap, or 100 pieces.

ITEM #	STYLE #	DESCRIPTION	LENGTH OVERALL WITH HOOK	MAXIMUM STRETCH WITH HOOK	STANDARD PACKAGE	TARP STRAP LENGTH
269109	635197920	Strap without Hooks	13 in.	18 in.	50	10 in.
269115	635197820	Strap without Hooks	18 in.	25 in.	50	15 in.
269120	635196920	Strap without Hooks	24 in.	34 in.	50	21 in.
269210	635197930	Strap with Hooks Loose in Box	13 in.	18 in.	50	10 in.
269215	635197830	Strap with Hooks Loose in Box	18 in.	25 in.	50	15 in.
269221	635196930	Strap with Hooks Loose in Box	24 in.	34 in.	50	21 in.
269231	635197730	Strap with Hooks Loose in Box	34 in.	49 in.	50	31 in.
269310	635197940	Strap with Hooks Inserted	13 in.	18 in.	50	10 in.
269315	635197840	Strap with Hooks Inserted	18 in.	25 in.	50	15 in.
269321	635196940	Strap with Hooks Inserted	24 in.	34 in.	50	21 in.
269331	635197740	Strap with Hooks Inserted	34 in.	49 in.	50	31 in.
269341	635738940	Strap with Hooks Inserted	44 in.	66 in.	50	41 in.

UNIVERSAL POLYMER Warning for EPDM TARP AND TIE-DOWN STRAPS: Observe maximum stretch warnings. Straps should not be stretched more than 50% of their normal length. Sudden disconnect in a stretched position may cause serious eye injury. Wear safety glasses during tie down and disconnect. Inspect straps before each use. Discard if abraded, cut or cracked. Straps should not be substituted as primary tie-down device for load.

Goldline® is a registered trademark of Universal Polymer & Rubber LTD.



269200

Hook – Tarp Strap “S”

ITEM #	STYLE #	LENGTH	MATERIAL	SIZE OPENING	STANDARD PACKAGE
239801	1	1-11/16 in.	Zinc-Plated Steel	3/8 in.	100
239803	3	1-5/8 in.	Zinc-Plated Steel	5/8 in.	100
269200		2-1/2 in.	Stainless Steel	9/16 in.	100
269202		2-1/2 in.	Galvanized Steel	7/8 in.	100
269204		4-1/2 in.	Galvanized Steel	1 in. / 7/8 in.	100



261992

Tie-Down – EPDM Rope Standard Black

Use anywhere constant tension is needed. Just cut the cord to the length required, apply the galvanized double eye hooks at both ends, and it's ready for use. Will not crack, chip or peel. Use in any weather.

ITEM #	STYLE #	PUT UP	ROPE SIZE	STANDARD PACKAGE	WEIGHT
261991	933037502	200 ft. coil	3/8 in.	1	13 lbs.
261990	933037501	200 ft. coil with 150 double eye hooks	3/8 in.	1	22 lbs.
261992	933037503	800 ft. coil	3/8 in.	1	50 lbs.

UNIVERSAL POLYMER Warning for EPDM ROPE TIE-DOWNS: Sudden disconnect in a stretched position may cause serious eye injury. Wear safety glasses during tie down and disconnect. Inspect before use. Discard if abraded, cut or cracked.



261993

Tie-Down – EPDM Rope Heavy Duty Black

Use anywhere constant tension is needed. Just cut the cord to the length required, apply the galvanized double eye hooks at both ends, and it's ready for use. Will not crack, chip or peel. Use in any weather.



261996

ITEM #	STYLE #	DESCRIPTION	PUT UP	ROPE SIZE	STANDARD PACKAGE	WEIGHT
261994	933043701		150 ft. coil	7/16 in.	1	13 lbs.
261993	933043702		150 ft. coil with 150 double eye hooks	7/16 in.	1	22 lbs.
261995	933043703		600 ft. coil	7/16 in.	1	48 lbs.
261996		Galvanized Double Eye Hooks			1000	

UNIVERSAL POLYMER Warning for EPDM ROPE TIE-DOWNS: Sudden disconnect in a stretched position may cause serious eye injury. Wear safety glasses during tie down and disconnect. Inspect before use. Discard if abraded, cut or cracked. Coil only in Display Carton.



266679

Snap – Bolt

Malleable iron, loop eye.

ITEM #	STYLE #	FINISH	LENGTH	MATERIAL	STANDARD PACKAGE	WEBBING SIZE
266679	25	Cadmium Plated	3-1/4 in.	Malleable Iron	10	1 in.



266675

Snap – Curtain Trigger

Made of malleable iron. Used to fasten down roller curtains. Zinc plated.

ITEM #	STYLE #	LENGTH	STANDARD PACKAGE	WEBBING SIZE
266675	204	1-3/4 in.	10	3/4 in.



266895

Snap – Spring



266672

ITEM #	STYLE #	FINISH	LENGTH	MATERIAL	STANDARD PACKAGE	WEBBING SIZE
266680	200	Cadmium Plated	3-1/16 in.	Malleable Iron	10	1 in.
266876	349			Stainless Steel	100	1 in.
266895	5016	Nickel Plated	2-5/8 in.	Steel	100	1 in.
266904	5350	Nickel Plated	1-3/4 in.	Steel	20	1 in.
266685	900ST	Nickel Plated		Steel	100	1 in.
266741	142-A	Zinc Plated	2-1/8 in.	Steel	100	1 in.
266672	200	Cadmium Plated	3-9/16 in.	Malleable Iron	10	1-1/2 in.
266681	142-A	Nickel Plated	1-15/16 in.	Steel	100	1-1/2 in.
266674	200	Cadmium Plated	3-3/4 in.	Zinc	10	2 in.
266767	249	Brass	2-1/2 in.	Brass	100	3/4 in.

Snap – Tent Wall

ITEM #	STYLE #	FINISH	MATERIAL	STANDARD PACKAGE	WEBBING SIZE
266686	340Z	Nickel Plated	Zinc Die Cast	500	1 in.



267306

Trailer Awning Spring

Designed to equalize tension on guy lines of trailer awnings and eliminate adjustment. Equipped with loops at each end for rope fastening. Made of high-grade wire to provide flexibility. Zinc-plated.

ITEM #	LENGTH	STANDARD PACKAGE
267306	4-5/8 in.	1



130609

Eave Web Guy Fitting

A plated, stamped steel fitting to accommodate supporting web, pole and guy line. Fitting has a round hole for guy line, 7/8 inch hole for side pole, and oblong hole for webbing. Fitting is also designed for attachment of eave rope. Will accommodate webbing up to 2 inch in width.

ITEM #	STYLE #	STANDARD PACKAGE
130609	162	25



266514

Tent Slide

Stamped galvanized steel.

ITEM #	STYLE #	LENGTH	ROPE SIZE	STANDARD PACKAGE
266514	4	4 in.	5/16 in.	500



266504

Tent Slip

Injection-molded, glass-filled nylon, 4 inch long for 5/16 inch diameter rope. Meets spec. MIL-S-1734 Type II.

ITEM #	COLOR	LENGTH	ROPE SIZE	STANDARD PACKAGE
266504	Olive Drab	4 in.	5/16 in.	700



267612

Tent Stake – Steel

Formed of heavy-gauge, pre-coated galvanized steel. Specially designed top provides maximum strength with minimum weight.

ITEM #	LENGTH	STANDARD PACKAGE
267609	9 in.	100
267612	12 in.	100
267615	15 in.	100



267710

Tent Stake – Kinked Wire

A sturdy all-steel tent stake with slash-cut end, and kinked body made of 1/4 in. diameter steel. Bright zinc plating adds lasting protection. Can also be used for ground fastening of sunshades, wind baffles and privacy screens.

ITEM #	LENGTH	STANDARD PACKAGE
267709	9 in.	100
267710	9 in.	1000



267500

Tent Stake – Polypropylene

Made to withstand heavy usage. Superior strength in temperature extremes.

ITEM #	COLOR	LENGTH	STANDARD PACKAGE
267500	Yellow	9 in.	300

YKK® AQUAGUARD®

AQUAGUARD® zippers have a shiny polyurethane coating with an embossed finish that sheds water, as well as enhancing the appearance. These zippers can be ultrasonically bonded or sewn.

ITEM #	STYLE #	COLOR	LENGTH	STANDARD PACKAGE
280869	UR CT40L-101 DFBL 67752	Black	240 in.	10

YKK® and AQUAGUARD® are registered trademarks of YKK Corporation in Japan and other countries/regions.



280331

YKK® VISLON® 10VF No. 10 Sliders – Metal

ITEM #	STYLE #	DESCRIPTION	COLOR	COLOR #	STANDARD PACKAGE
280363	10VFDX	AutoLok Double Pull	Black	580	100
280336	10CFDX	AutoLok Double Pull	White	501	100
280362	10VFDA	AutoLok Single Pull	Black	580	100
280595	10VFDA	AutoLok Single Pull	Light Beige		1000
280334	10VFDA	AutoLok Single Pull	White	501	1000
280873	10VFDWL	Non-Locking Long Double Pull Tab	Black	580	100
280872	10VFDWL	Non-Locking Long Double Pull Tab	White	501	100
280369	10VDFWW	Non-Locking Short Double Pull Tab	Black	580	100
280332	10VDFWW	Non-Locking Short Double Pull Tab	White	501	100
280331	10VDFW	Non-Locking Short Single Pull Tab	Black	580	100
280330	10VDFW	Non-Locking Short Single Pull Tab	White	501	100
280950	10VDFL	Non-Locking Single Pull	Black	580	100

YKK® and VISLON® are registered trademarks of YKK Corporation in Japan and other countries/regions.



280361

YKK® VISLON® 10VF No. 10 Sliders – Plastic

ITEM #	STYLE #	DESCRIPTION	COLOR	COLOR #	STANDARD PACKAGE
280360	10VFTA	AutoLok Single Pull	White	501	100
280361	10VFTA	AutoLok Single Pull	Black	580	100
280364	10VFTX	AutoLok Double Pull	White	501	100
280365	10VFTX	AutoLok Double Pull	Black	580	100
280366	10VFTW	Non-Locking Short Double Pull Tab	White	501	100

YKK® and VISLON® are registered trademarks of YKK Corporation in Japan and other countries/regions.



280311

YKK® VISLON® 10VFUV No. 10 Chain (VF)

Full rolls only.

ITEM #	STYLE #	COLOR	COLOR #	STANDARD PACKAGE	WIDTH
280311	10VF	Black	580	109 yds.	11/16 in.
280309	10VF	Black	580	55 yds.	11/16 in.
299398	10VF	White	501	109 yds.	11/16 in.
280307	10VF	White	501	55 yds.	11/16 in.

YKK® and VISLON® are registered trademarks of YKK Corporation in Japan and other countries/regions.



295641

YKK® VISLON® 5VS No. 5 Sliders – Metal

ITEM #	STYLE #	DESCRIPTION	COLOR	COLOR #	STANDARD PACKAGE
295658	5VSDXL	AutoLok Standard Double Pull Tab	Black	580	100
295657	5VSDXL	AutoLok Standard Double Pull Tab	White	501	100
295654	5VSDA	AutoLok Standard Single Pull Tab	Black	580	100
295653	5VSDA	AutoLok Standard Single Pull Tab	White	501	100
295650	5VSDWL	Non-Locking Long Double Pull Tab	Black	580	100
295649	5VSDWL	Non-Locking Long Double Pull Tab	White	501	100
295642	5VSDFL	Non-Locking Long Single Pull Tab	Beige	573	100
295641	5VSDFL	Non-Locking Long Single Pull Tab	Black	580	100
295640	5VSDFL	Non-Locking Long Single Pull Tab	White	501	100
295646	5VSDFW	Non-Locking Short Single Pull Tab	Black	580	100
295645	5VSDFW	Non-Locking Short Single Pull Tab	White	501	100

YKK® and VISLON® are registered trademarks of YKK Corporation in Japan and other countries/regions.



295670

YKK® VISLON® 5VS No. 5 Sliders – Plastic

ITEM #	STYLE #	DESCRIPTION	COLOR	COLOR #	STANDARD PACKAGE
295674	5VSTX	AutoLok Standard Double Pull Tab	Black	580	100
295670	5VSTA	AutoLok Standard Single Pull Tab	Black	580	100
295669	5VSTA	AutoLok Standard Single Pull Tab	White	501	100
295665	5VSTW	Non-Locking Short Double Pull Tab	White	501	100
295662	5VSTF	Non-Locking Short Single Pull Tab	Black	580	100
295661	5VSTF	Non-Locking Short Single Pull Tab	White	501	100

YKK® and VISLON® are registered trademarks of YKK Corporation in Japan and other countries/regions.



295627

YKK® VISLON® 5VS No. 5 Chain

Full rolls only.

ITEM #	STYLE #	COLOR	COLOR #	STANDARD PACKAGE	WIDTH
295630	5VS	Beige	573	218 yds.	9/16 in.
295627	5VS	Black	580	109 yds.	9/16 in.
295628	5VS	Black	580	218 yds.	9/16 in.
295625	5VS	White	501	109 yds.	9/16 in.
295626	5VS	White	501	218 yds.	9/16 in.

YKK® and VISLON® are registered trademarks of YKK Corporation in Japan and other countries/regions.



280922

YKK® VISLON® 8VF No. 8 Sliders – Metal

ITEM #	STYLE #	DESCRIPTION	COLOR	COLOR #	STANDARD PACKAGE
280938	8VFDXL	AutoLok Long Double Pull Tab	Black	580	1000
280926	8VFDXL	AutoLok Long Double Pull Tab	White	501	1000
280922	8VFDA	AutoLok Single Pull	Black	580	100
280920	8VFDA	AutoLok Single Pull	White	501	100

YKK® and VISLON® are registered trademarks of YKK Corporation in Japan and other countries/regions.



280910

YKK® VISLON® 8VFUV No. 8 Chain

Full rolls only.

ITEM #	STYLE #	COLOR	COLOR #	STANDARD PACKAGE	WIDTH
280910	8VFUV	Black	580	137 yds.	5/8 in.
280900	8VFUV	White	501	137 yds.	5/8 in.

YKK® and VISLON® are registered trademarks of YKK Corporation in Japan and other countries/regions.



279836

YKK® ZIPLON® Sliders – Metal

ITEM #	STYLE #	DESCRIPTION	COLOR	COLOR #	FINISH	STANDARD PACKAGE
279836	5CND A5	AutoLok Single Pull Tab	Black	580		100
279835	5CND A5	AutoLok Single Pull Tab	White	501		100
280512	10CFDA3	AutoLok Single Pull	Black	580		100
280511	10CFDA3	AutoLok Single Pull	White	501		100
280341	8CFDWL	Non-Locking Long Double Pull Tab	Black	580		100
279846	5CNDW3L	Non-Locking Long Double Pull Tab	Black	580		100
280368	10CFDWL	Non-Locking Long Double Pull Tab	Black	580		100
280339	10CFDWL	Non-Locking Long Double Pull Tab	White	501		100
279845	5CNDW3L	Non-Locking Long Double Pull Tab	White	501		100
280515	8CNDFL	Non-Locking Long Single Pull Tab			Nickel Plated	100
280317	4.5CNDFL	Non-Locking Long Single Pull Tab			Nickel Plated	100
280338	10CFDFL	Non-Locking Long Single Pull Tab			Nickel Plated	100
279842	5CNDFL	Non-Locking Long Single Pull Tab			Nickel Plated	100
280514	8CNDFL	Non-Locking Long Single Pull Tab	Black	580		100
280348	10CFDFL	Non-Locking Long Single Pull Tab	Black	580		100
280319	4.5CNDFL	Non-Locking Long Single Pull Tab	Black	580		100
279841	5CNDFL	Non-Locking Long Single Pull Tab	Black	580		100
280349	10CFDFL	Non-Locking Long Single Pull Tab	White	501		100
279834	10CFDFL	Non-Locking Long Single Pull Tab	White		Powder Coated	100
280510	8CFFDFL	Non-Locking Long Single Pull Tab	White	501		100
279840	5CNDFL	Non-Locking Long Single Pull Tab	White	501		100

YKK® and ZIPLON® are registered trademarks of YKK Corporation in Japan and other countries/regions.



279831

YKK® ZIPLON® Chain (CF)

Full rolls only.

ITEM #	STYLE #	COLOR	COLOR #	STANDARD PACKAGE	WIDTH
280509	8CF	Beige	573	165 yds.	3/4 in.
280316	10CF	Black	580	109 yds.	3/4 in.
280291	4.5CF	Black	580	218 yds.	5/8 in.
279831	5CF	Black	580	218 yds.	5/8 in.
280505	8CF	Black	580	165 yds.	3/4 in.
280591	8CF	Black	580	165 yds.	5/8 in.
280502	9CF	Black	580	109 yds.	3/4 in.
280315	10CF	White	501	109 yds.	3/4 in.
280290	4.5CF	White	501	218 yds.	5/8 in.
279830	5CF	White	501	218 yds.	5/8 in.
280504	8CF	White	501	165 yds.	3/4 in.

YKK® and ZIPLON® are registered trademarks of YKK Corporation in Japan and other countries/regions.



586090

YKK® Pull Cord

ITEM #	STYLE #	COLOR	CORD SIZE	LENGTH
586090	LCWE	Black	1/10 in.	4.5 in.

YKK® is a registered trademark of YKK Corporation in Japan and other countries/regions.



280492

YKK® VISLON® Bottom Stops

ITEM #	STYLE #	COLOR	COLOR #	STANDARD PACKAGE
280492	10 VF	Black	580	100
295681	5 VS	Black	580	100
280550	10 VF	White	501	100
295680	5 VS	White	501	100

YKK® and Vislon® are registered trademarks of YKK Corporation.



280493

YKK® VISLON® Top Stops

ITEM #	STYLE #	COLOR	COLOR #	STANDARD PACKAGE
280493	10 VF	Black	580	100
280547	10 VF	White	501	100
295682	5 VS	White	501	100
295683	5 VS	Black	580	100

YKK® and VISLON® are registered trademarks of YKK Corporation in Japan and other countries/regions.



280490

YKK® SNAPCAP®

This revolutionary zipper top-stop is ready for assembling. Available in black and white.

ITEM #	COLOR	COLOR #	STANDARD PACKAGE
280490	Black	580	2000
280491	White	501	2000

YKK® and SNAPCAP® are registered trademarks of YKK Corporation in Japan and other countries/regions.



280974

Top Stop No. 10

No. 10 Zipper Top Stop is placed over a tooth on each side of the zipper and bent in place with pliers. It eliminates the need to cut the zipper and chain with a hot knife or sew it down to form a stop. Providing added flexibility, the Stainless Steel Zipper Top Stop can be moved if needed.

ITEM #	STYLE #	MATERIAL	STANDARD PACKAGE
280974	89001	Stainless Steel	1000



255251

Zipper Stop Application Tool

Convenient tool designed specifically to apply Zipper Stop to zipper chain, helping eliminate slippage and rotation of the stop. Features a special groove that firmly holds zipper stop in place.

ITEM #	STYLE #	STANDARD PACKAGE
255251	1012	1



255252

Zipper Jig

Save time during zipper installations with the Zipper Jig. This handy tool holds YKK® zipper sliders from #2.5 to #10, allowing you to easily install sliders. The lower clamp securely holds the Zipper Jig to a counter, while the upper clamp is used to lock the jig rod in any direction. It even allows you to put a zipper on backwards. The Zipper Jig is 5-1/2 inch x 4-3/4 inch, making it ideal for workstations.

To use simply place the slider upside-down and facing forward into the slot on the rod. Open the zipper one or two inches and hold face down. Feed both sides evenly into the slider held by the rod, coming in at a 45 degree angle. Pull forward and it's done!

ITEM #	STYLE #	STANDARD PACKAGE
255252	1014	1



YKK® is a registered trademark of YKK Corporation.

YKK® VISLON® UV VFUV No. 10 Separating Zipper Automatic Lock

Engineered especially for marine applications. All element and slider materials are scientifically designed to resist damage from sunlight as well as corrosion. Teeth injection-molded from DuPont™ Delrin®.

UV-resistant acetal resin attached to a strong cord and tape, which ensure the sliders stay on track. The Delrin polymer reduces the effect of ultraviolet radiation, significantly increasing its useful life.

ITEM #	STYLE #	DESCRIPTION	COLOR	COLOR #	LENGTH	STANDARD PACKAGE
279872	VFUV	Single Pull Metal Slider	Black	32483	108 in.	10
279868	VFUV	Double Pull Metal Slider	Black	41578	144 in.	10
279866	VFUV	Double Pull Nylon Slider	Black	32241	78 in.	10

YKK® and VISLON® are registered trademarks of YKK Corporation in Japan and other countries/regions. Dupont™ is a trademark of E.I. Dupont de Nemours and Company, Inc. Delrin® is a registered trademark of E.I. Dupont de Nemours and Company, Inc.



279893

YKK® VISLON® UV VFUV No. 8 Separating Zipper Non-Locking – Double Pull Metal Slider

Engineered especially for marine applications. All element and slider materials are scientifically designed to resist damage from sunlight as well as corrosion. Teeth injection-molded from DuPont™ Delrin®.

UV-resistant acetal resin attached to a strong cord and tape, which ensure the sliders stay on track. The Delrin polymer reduces the effect of ultraviolet radiation, significantly increasing its useful life.

ITEM #	STYLE #	COLOR	COLOR #	LENGTH	STANDARD PACKAGE
279890	VFUV	Black	32238	18 in.	10
279891	VFUV	Black	32238	24 in.	10
279893	VFUV	Black	32238	36 in.	10
279895	VFUV	Black	32238	42 in.	10
279896	VFUV	Black	32238	48 in.	10
279897	VFUV	Black	32238	54 in.	10
279898	VFUV	Black	32238	60 in.	10
279900	VFUV	Black	32238	72 in.	10
279875	VFUV	White	32438	18 in.	10
279876	VFUV	White	32438	24 in.	10
279878	VFUV	White	32438	36 in.	10
279879	VFUV	White	32438	42 in.	10
279880	VFUV	White	32438	48 in.	10
279881	VFUV	White	32438	54 in.	10
279882	VFUV	White	32438	60 in.	10
279884	VFUV	White	32438	72 in.	10

YKK® and VISLON® are registered trademarks of YKK Corporation in Japan and other countries/regions. DuPont™ is a trademark of E.I. DuPont de Nemours and Company, Inc. Delrin® is a registered trademark of E.I. DuPont de Nemours and Company, Inc.



296215

YKK® VISLON® VFOL105W No. 10 Separating Zipper Non-Locking – Double Pull Metal Slider

YKK® No. 10 VISLON® Separating Zippers are extremely strong and lightweight and differ from conventional zippers, because the “teeth” are made from Delrin® and the tape is polyester. Because of the unique properties of the Vislon Zipper, it has a wide variety of industrial, consumer and military applications where environmental conditions reduce the effectiveness of metal zippers.

The VISLON Zipper is corrosion resistant. The zipper is self-lubricating and operates smoothly despite mud, sand, etc. The color is an integral part of the molding material, creating a finish that does not rub off, peel or chip.

ITEM #	STYLE #	COLOR	COLOR #	LENGTH	STANDARD PACKAGE
296215	VFOL105W	Black	580	60 in.	10
296234	VFOL105W	Onion	801	72 in.	10

YKK® and VISLON® are registered trademarks of YKK Corporation in Japan and other countries/regions. Delrin® is a registered trademark of E.I. DuPont de Nemours and Company, Inc.



280596

YKK® VISLON® VFUL106 TA No. 10 Separating Zipper With Automatic Lock – Short Single Pull Plastic Slider

YKK® No. 10 VISLON® Separating Zippers are extremely strong and lightweight and differ from conventional zippers, because the “teeth” are made from Delrin® and the tape is polyester. Because of the unique properties of the Vislon Zipper, it has a wide variety of industrial, consumer and military applications where environmental conditions reduce the effectiveness of metal zippers.

The VISLON Zipper is corrosion resistant. The zipper is self-lubricating and operates smoothly despite mud, sand, etc. The color is an integral part of the molding material, creating a finish that does not rub off, peel or chip.

ITEM #	STYLE #	COLOR	COLOR #	LENGTH	STANDARD PACKAGE
280617	VFUL106 TA	Black	580	108 in.	10
280619	VFUL106 TA	Black	580	120 in.	10
280596	VFUL106 TA	Black	580	24 in.	10
280598	VFUL106 TA	Black	580	26 in.	10
280604	VFUL106 TA	Black	580	48 in.	10
280606	VFUL106 TA	Black	580	60 in.	10
280608	VFUL106 TA	Black	580	72 in.	10
280612	VFUL106 TA	Black	580	96 in.	10
280548	VFUL106 TA	White	501	120 in.	10
280520	VFUL106 TA	White	501	24 in.	10
280522	VFUL106 TA	White	501	36 in.	10
280528	VFUL106 TA	White	501	48 in.	10
280532	VFUL106 TA	White	501	60 in.	10
280536	VFUL106 TA	White	501	72 in.	10
280538	VFUL106 TA	White	501	84 in.	10
280540	VFUL106 TA	White	501	96 in.	10

YKK® and VISLON® are registered trademarks of YKK Corporation in Japan and other countries/regions. Delrin® is a registered trademark of E.I. DuPont de Nemours and Company, Inc.



280243

YKK® VISLON® VFULVOL-107 DX E No. 10 Separating Zipper With Automatic Lock – Short Double Pull Metal Slider

YKK® No. 10 VISLON® Separating Zippers are extremely strong and lightweight and differ from conventional zippers, because the “teeth” are made from Delrin® and the tape is polyester. Because of the unique properties of the Vislon Zipper, it has a wide variety of industrial, consumer and military applications where environmental conditions reduce the effectiveness of metal zippers.

The VISLON Zipper is corrosion resistant. The zipper is self-lubricating and operates smoothly despite mud, sand, etc. The color is an integral part of the molding material, creating a finish that does not rub off, peel or chip.

ITEM #	STYLE #	COLOR	COLOR #	LENGTH	STANDARD PACKAGE
280243	VFULVOL-107 DX E	Natural	572	96 in.	10

YKK® and VISLON® are registered trademarks of YKK Corporation in Japan and other countries/regions. Delrin® is a registered trademark of E.I. DuPont de Nemours and Company, Inc.



296180

Zipper – YKK® VISLON® VFUVOL-106 DA E No. 10 Separating Zipper With Automatic Lock – Short Single Pull Metal Slider

YKK® No. 10 VISLON® Separating Zippers are extremely strong and lightweight and differ from conventional zippers, because the “teeth” are made from Delrin® and the tape is polyester. Because of the unique properties of the Vislon Zipper, it has a wide variety of industrial, consumer and military applications where environmental conditions reduce the effectiveness of metal zippers.

The VISLON Zipper is corrosion resistant. The zipper is self-lubricating and operates smoothly despite mud, sand, etc. The color is an integral part of the molding material, creating a finish that does not rub off, peel or chip.

ITEM #	STYLE #	COLOR	COLOR #	LENGTH	STANDARD PACKAGE
296196	VFUVOL-106 DA E	Black	580	110 in.	10
296183	VFUVOL-106 DA E	Black	580	12 in.	10
296198	VFUVOL-106 DA E	Black	580	120 in.	10
296199	VFUVOL-106 DA E	Black	580	144 in.	10
296180	VFUVOL-106 DA E	Black	580	24 in.	10
296182	VFUVOL-106 DA E	Black	580	36 in.	10
296184	VFUVOL-106 DA E	Black	580	42 in.	10
296185	VFUVOL-106 DA E	Black	580	48 in.	10
296186	VFUVOL-106 DA E	Black	580	54 in.	10
296187	VFUVOL-106 DA E	Black	580	60 in.	10
296190	VFUVOL-106 DA E	Black	580	72 in.	10
296192	VFUVOL-106 DA E	Black	580	84 in.	10
296194	VFUVOL-106 DA E	Black	580	96 in.	10
296178	VFUVOL-106 DA E	White	501	120 in.	10
296179	VFUVOL-106 DA E	White	501	144 in.	10
296156	VFUVOL-106 DA E	White	501	18 in.	10
296160	VFUVOL-106 DA E	White	501	24 in.	10
296162	VFUVOL-106 DA E	White	501	36 in.	10
296165	VFUVOL-106 DA E	White	501	48 in.	10
296167	VFUVOL-106 DA E	White	501	60 in.	10
296170	VFUVOL-106 DA E	White	501	72 in.	10
296172	VFUVOL-106 DA E	White	501	84 in.	10
296174	VFUVOL-106 DA E	White	501	96 in.	10

YKK® and VISLON® are registered trademarks of YKK Corporation in Japan and other countries/regions. Delrin® is a registered trademark of E.I. DuPont de Nemours and Company, Inc.



296119

YKK® VISLON® VFUVOL-107 DX E No. 10 Separating Zipper With Automatic Lock – Short Double Pull Metal Slider

YKK® No. 10 VISLON® Separating Zippers are extremely strong and lightweight and differ from conventional zippers, because the “teeth” are made from Delrin® and the tape is polyester. Because of the unique properties of the Vislon Zipper, it has a wide variety of industrial, consumer and military applications where environmental conditions reduce the effectiveness of metal zippers.

The VISLON Zipper is corrosion resistant. The zipper is self-lubricating and operates smoothly despite mud, sand, etc. The color is an integral part of the molding material, creating a finish that does not rub off, peel or chip.

ITEM #	STYLE #	COLOR	COLOR #	LENGTH	STANDARD PACKAGE
296145	VFUVOL-107 DX E	Black	580	100 in.	10
296147	VFUVOL-107 DX E	Black	580	108 in.	10
296149	VFUVOL-107 DX E	Black	580	110 in.	10
296118	VFUVOL-107 DX E	Black	580	12 in.	10
296151	VFUVOL-107 DX E	Black	580	120 in.	10
296116	VFUVOL-107 DX E	Black	580	16 in.	10
296120	VFUVOL-107 DX E	Black	580	18 in.	10
296119	VFUVOL-107 DX E	Black	580	20 in.	10
296122	VFUVOL-107 DX E	Black	580	24 in.	10
296154	VFUVOL-107 DX E	Black	580	240 in.	10
296124	VFUVOL-107 DX E	Black	580	30 in.	10
296125	VFUVOL-107 DX E	Black	580	34 in.	10
296126	VFUVOL-107 DX E	Black	580	36 in.	10
296128	VFUVOL-107 DX E	Black	580	40 in.	10
296129	VFUVOL-107 DX E	Black	580	42 in.	10
296134	VFUVOL-107 DX E	Black	580	46 in.	10
296131	VFUVOL-107 DX E	Black	580	48 in.	10
296133	VFUVOL-107 DX E	Black	580	54 in.	10
296135	VFUVOL-107 DX E	Black	580	60 in.	10
296137	VFUVOL-107 DX E	Black	580	66 in.	10
296142	VFUVOL-107 DX E	Black	580	68 in.	10
296139	VFUVOL-107 DX E	Black	580	72 in.	10
296144	VFUVOL-107 DX E	Black	580	76 in.	10
296146	VFUVOL-107 DX E	Black	580	80 in.	10
296141	VFUVOL-107 DX E	Black	580	84 in.	10
296148	VFUVOL-107 DX E	Black	580	90 in.	10
296143	VFUVOL-107 DX E	Black	580	96 in.	10
296265	VFUVOL-107 DX E	Light Beige	573	120 in.	10
296270	VFUVOL-107 DX E	Light Beige	573	144 in.	10
296233	VFUVOL-107 DX E	Light Beige	573	18 in.	10
296236	VFUVOL-107 DX E	Light Beige	573	24 in.	10
296237	VFUVOL-107 DX E	Light Beige	573	30 in.	10
296239	VFUVOL-107 DX E	Light Beige	573	36 in.	10
296242	VFUVOL-107 DX E	Light Beige	573	42 in.	10
296245	VFUVOL-107 DX E	Light Beige	573	48 in.	10
296248	VFUVOL-107 DX E	Light Beige	573	54 in.	10
296251	VFUVOL-107 DX E	Light Beige	573	60 in.	10
296254	VFUVOL-107 DX E	Light Beige	573	72 in.	10
296257	VFUVOL-107 DX E	Light Beige	573	84 in.	10
296260	VFUVOL-107 DX E	Light Beige	573	96 in.	10
296089	VFUVOL-107 DX E	White	501	100 in.	10
296091	VFUVOL-107 DX E	White	501	108 in.	10
296092	VFUVOL-107 DX E	White	501	110 in.	10

ITEM #	STYLE #	COLOR	COLOR #	LENGTH	STANDARD PACKAGE
296094	VFUVOL-107 DX E	White	501	120 in.	10
296098	VFUVOL-107 DX E	White	501	144 in.	10
296099	VFUVOL-107 DX E	White	501	154 in.	10
296061	VFUVOL-107 DX E	White	501	18 in.	10
296063	VFUVOL-107 DX E	White	501	24 in.	10
296105	VFUVOL-107 DX E	White	501	240 in.	10
296065	VFUVOL-107 DX E	White	501	30 in.	10
296068	VFUVOL-107 DX E	White	501	36 in.	10
296069	VFUVOL-107 DX E	White	501	40 in.	10
296070	VFUVOL-107 DX E	White	501	42 in.	10
296072	VFUVOL-107 DX E	White	501	48 in.	10
296074	VFUVOL-107 DX E	White	501	54 in.	10
296076	VFUVOL-107 DX E	White	501	60 in.	10
296080	VFUVOL-107 DX E	White	501	66 in.	10
296082	VFUVOL-107 DX E	White	501	72 in.	10
296084	VFUVOL-107 DX E	White	501	78 in.	10
296086	VFUVOL-107 DX E	White	501	84 in.	10
296087	VFUVOL-107 DX E	White	501	90 in.	10
296088	VFUVOL-107 DX E	White	501	96 in.	10

YKK® and VISLON® are registered trademarks of YKK Corporation in Japan and other countries/regions. Delrin® is a registered trademark of E.I. DuPont de Nemours and Company, Inc.

YKK® VISLON® VFUVOL-86 DA E No. 8 Separating Zipper With Automatic Lock – Short Single Pull Metal Slider

YKK® No. 8 VISLON® Separating Zippers are extremely strong and lightweight and differ from conventional zippers, because the “teeth” are made from Delrin® and the tape is polyester. Because of the unique properties of the Vislon Zipper, it has a wide variety of industrial, consumer and military applications where environmental conditions reduce the effectiveness of metal zippers.

The VISLON Zipper is corrosion resistant. The zipper is self-lubricating and operates smoothly despite mud, sand, etc. The color is an integral part of the molding material, creating a finish that does not rub off, peel or chip.

ITEM #	STYLE #	COLOR	COLOR #	LENGTH	STANDARD PACKAGE
280690	VFUVOL-86 DA E	Black	580	36 in.	10
280692	VFUVOL-86 DA E	Black	580	48 in.	10
280681	VFUVOL-86 DA E	White	501	42 in.	10
280682	VFUVOL-86 DA E	White	501	48 in.	10

YKK® and VISLON® are registered trademarks of YKK Corporation in Japan and other countries/regions. Delrin® is a registered trademark of E.I. DuPont de Nemours and Company, Inc.



280758

YKK® VISLON® VFUVOL-87 DXL E No. 8 Separating Zipper With Automatic Lock – Long Double Pull Metal Slider

YKK® No. 8 VISLON® Separating Zippers are extremely strong and lightweight and differ from conventional zippers, because the “teeth” are made from Delrin® and the tape is polyester. Because of the unique properties of the Vislon Zipper, it has a wide variety of industrial, consumer and military applications where environmental conditions reduce the effectiveness of metal zippers.

The VISLON Zipper is corrosion resistant. The zipper is self-lubricating and operates smoothly despite mud, sand, etc. The color is an integral part of the molding material, creating a finish that does not rub off, peel or chip.

ITEM #	STYLE #	COLOR	COLOR #	LENGTH	STANDARD PACKAGE
280770	VFUVOL-87 DXL E	Black	580	110 in.	10
280772	VFUVOL-87 DXL E	Black	580	120 in.	10
280740	VFUVOL-87 DXL E	Black	580	18 in.	10
280741	VFUVOL-87 DXL E	Black	580	22 in.	10
280742	VFUVOL-87 DXL E	Black	580	24 in.	10
280744	VFUVOL-87 DXL E	Black	580	30 in.	10
280746	VFUVOL-87 DXL E	Black	580	36 in.	10
280748	VFUVOL-87 DXL E	Black	580	40 in.	10
280750	VFUVOL-87 DXL E	Black	580	42 in.	10
280752	VFUVOL-87 DXL E	Black	580	48 in.	10
280754	VFUVOL-87 DXL E	Black	580	54 in.	10
280756	VFUVOL-87 DXL E	Black	580	60 in.	10
280758	VFUVOL-87 DXL E	Black	580	66 in.	10
280760	VFUVOL-87 DXL E	Black	580	72 in.	10
280762	VFUVOL-87 DXL E	Black	580	78 in.	10
280764	VFUVOL-87 DXL E	Black	580	84 in.	10
280766	VFUVOL-87 DXL E	Black	580	96 in.	10
280810	VFUVOL-87 DXL E	Gray	576	110 in.	10
280787	VFUVOL-87 DXL E	Gray	576	38 in.	10
280792	VFUVOL-87 DXL E	Gray	576	48 in.	10
280796	VFUVOL-87 DXL E	Gray	576	60 in.	10
280800	VFUVOL-87 DXL E	Gray	576	72 in.	10
280804	VFUVOL-87 DXL E	Gray	576	84 in.	10
280806	VFUVOL-87 DXL E	Gray	576	96 in.	10
280730	VFUVOL-87 DXL E	White	501	110 in.	10
280732	VFUVOL-87 DXL E	White	501	120 in.	10
280700	VFUVOL-87 DXL E	White	501	18 in.	10
280702	VFUVOL-87 DXL E	White	501	24 in.	10
280704	VFUVOL-87 DXL E	White	501	30 in.	10
280706	VFUVOL-87 DXL E	White	501	36 in.	10
280707	VFUVOL-87 DXL E	White	501	38 in.	10
280710	VFUVOL-87 DXL E	White	501	42 in.	10
280712	VFUVOL-87 DXL E	White	501	48 in.	10
280714	VFUVOL-87 DXL E	White	501	54 in.	10
280717	VFUVOL-87 DXL E	White	501	56 in.	10
280716	VFUVOL-87 DXL E	White	501	60 in.	10
280720	VFUVOL-87 DXL E	White	501	72 in.	10
280722	VFUVOL-87 DXL E	White	501	78 in.	10
280724	VFUVOL-87 DXL E	White	501	84 in.	10
280726	VFUVOL-87 DXL E	White	501	96 in.	10

YKK® and VISLON® are registered trademarks of YKK Corporation in Japan and other countries/regions. Delrin® is a registered trademark of E.I. DuPont de Nemours and Company, Inc.



280446

YKK® VISLON® VFUVOL107TX No. 10 Separating Zipper With Automatic Lock – Double-Pull Plastic Slider

YKK® No. 10 VISLON® Separating Zippers are extremely strong and lightweight and differ from conventional zippers, because the “teeth” are made from Delrin® and the tape is polyester. Because of the unique properties of the Vislon Zipper, it has a wide variety of industrial, consumer and military applications where environmental conditions reduce the effectiveness of metal zippers.

The VISLON Zipper is corrosion resistant. The zipper is self-lubricating and operates smoothly despite mud, sand, etc. The color is an integral part of the molding material, creating a finish that does not rub off, peel or chip.

ITEM #	STYLE #	COLOR	COLOR #	LENGTH	STANDARD PACKAGE
280442	VFUVOL107TX	Black	580	100 in.	10
280444	VFUVOL107TX	Black	580	108 in.	10
280446	VFUVOL107TX	Black	580	110 in.	10
280448	VFUVOL107TX	Black	580	120 in.	10
280418	VFUVOL107TX	Black	580	18 in.	10
280420	VFUVOL107TX	Black	580	24 in.	10
280421	VFUVOL107TX	Black	580	30 in.	10
280422	VFUVOL107TX	Black	580	36 in.	10
280424	VFUVOL107TX	Black	580	40 in.	10
280426	VFUVOL107TX	Black	580	42 in.	10
280428	VFUVOL107TX	Black	580	48 in.	10
280430	VFUVOL107TX	Black	580	54 in.	10
280432	VFUVOL107TX	Black	580	60 in.	10
280434	VFUVOL107TX	Black	580	66 in.	10
280436	VFUVOL107TX	Black	580	72 in.	10
280438	VFUVOL107TX	Black	580	84 in.	10
280440	VFUVOL107TX	Black	580	96 in.	10
280242	VFUVOL107TX	White	501	100 in.	10
280244	VFUVOL107TX	White	501	108 in.	10
280246	VFUVOL107TX	White	501	110 in.	10
280248	VFUVOL107TX	White	501	120 in.	10
280218	VFUVOL107TX	White	501	18 in.	10
280220	VFUVOL107TX	White	501	24 in.	10
280221	VFUVOL107TX	White	501	30 in.	10
280222	VFUVOL107TX	White	501	36 in.	10
280224	VFUVOL107TX	White	501	40 in.	10
280226	VFUVOL107TX	White	501	42 in.	10
280228	VFUVOL107TX	White	501	48 in.	10
280230	VFUVOL107TX	White	501	54 in.	10
280232	VFUVOL107TX	White	501	60 in.	10
280234	VFUVOL107TX	White	501	66 in.	10
280236	VFUVOL107TX	White	501	72 in.	10
280237	VFUVOL107TX	White	501	78 in.	10
280238	VFUVOL107TX	White	501	84 in.	10
280240	VFUVOL107TX	White	501	96 in.	10

YKK® and VISLON® are registered trademarks of YKK Corporation in Japan and other countries/regions. Delrin® is a registered trademark of E.I. DuPont de Nemours and Company, Inc.



295685

YKK® VISLON® VSOL56 No. 5 Separating Zipper With Automatic Lock – Short Single Pull Metal Slider

YKK® No. 5 VISLON® Separating Zippers are extremely strong and lightweight and differ from conventional zippers, because the “teeth” are made from Delrin® and the tape is polyester. Because of the unique properties of the Vislon Zipper, it has a wide variety of industrial, consumer and military applications where environmental conditions reduce the effectiveness of metal zippers.

The VISLON Zipper is corrosion resistant. The zipper is self-lubricating and operates smoothly despite mud, sand, etc. The color is an integral part of the molding material, creating a finish that does not rub off, peel or chip.

ITEM #	STYLE #	COLOR	COLOR #	LENGTH	STANDARD PACKAGE
295728	VSOL56	Black	580	108 in.	10
295733	VSOL56	Black	580	110 in.	10
295711	VSOL56	Black	580	12 in.	10
295730	VSOL56	Black	580	144 in.	10
295713	VSOL56	Black	580	24 in.	10
295714	VSOL56	Black	580	30 in.	10
295715	VSOL56	Black	580	36 in.	10
295716	VSOL56	Black	580	42 in.	10
295717	VSOL56	Black	580	44 in.	10
295745	VSOL56	Black	580	46 in.	10
295718	VSOL56	Black	580	48 in.	10
295685	VSOL56	Black	580	52 in.	10
295719	VSOL56	Black	580	54 in.	10
295720	VSOL56	Black	580	60 in.	10
295722	VSOL56	Black	580	72 in.	10
295724	VSOL56	Black	580	84 in.	10
295726	VSOL56	Black	580	96 in.	10
295707	VSOL56	White	501	108 in.	10
295690	VSOL56	White	501	12 in.	10
295709	VSOL56	White	501	144 in.	10
295692	VSOL56	White	501	24 in.	10
295693	VSOL56	White	501	30 in.	10
295694	VSOL56	White	501	36 in.	10
295695	VSOL56	White	501	42 in.	10
295687	VSOL56	White	501	46 in.	10
295697	VSOL56	White	501	48 in.	10
295698	VSOL56	White	501	54 in.	10
295699	VSOL56	White	501	60 in.	10
295701	VSOL56	White	501	72 in.	10
295703	VSOL56	White	501	84 in.	10
295705	VSOL56	White	501	96 in.	10

YKK® and VISLON® are registered trademarks of YKK Corporation in Japan and other countries/regions. Delrin® is a registered trademark of E.I. DuPont de Nemours and Company, Inc.

YKK® VISLON® VFUVOL-86 DA E 5/8 No. 8 Separating Zipper With Automatic Lock – Single Pull Metal Slider

ITEM #	STYLE #	COLOR	LENGTH	STANDARD PACKAGE
280085	VFUVOL86 DA E 5/8	Black	60 in.	10

YKK® and VISLON® are registered trademarks of YKK Corporation in Japan and other countries/regions.

YKK® ZIPLON® CFOR-106 DA E No. 10 Separating Zipper with Automatic Lock – Single Pull Metal Slider

ITEM #	STYLE #	COLOR	COLOR #	LENGTH	STANDARD PACKAGE
295779	CFOR-106 DA E	Black	580	108 in.	10
295767	CFOR-106 DA E	Black	580	36 in.	10
295769	CFOR-106 DA E	Black	580	48 in.	10
295771	CFOR-106 DA E	Black	580	60 in.	10
295773	CFOR-106 DA E	Black	580	72 in.	10
295775	CFOR-106 DA E	Black	580	84 in.	10
295777	CFOR-106 DA E	Black	580	96 in.	10
295778	CFOR-106 DA E	White	501	108 in.	10
295766	CFOR-106 DA E	White	501	36 in.	10
295768	CFOR-106 DA E	White	501	48 in.	10
295770	CFOR-106 DA E	White	501	60 in.	10
295772	CFOR-106 DA E	White	501	72 in.	10
295774	CFOR-106 DA E	White	501	84 in.	10
295776	CFOR-106 DA E	White	501	96 in.	10

YKK® and ZIPLON® are registered trademarks of YKK Corporation in Japan and other countries/regions. .

YKK® ZIPLON® CFOR-105 DWL No. 10 Separating Zipper Non-Locking – Double Pull Metal Slider

ITEM #	STYLE #	COLOR	COLOR #	LENGTH	STANDARD PACKAGE
295973	CFOR-105 DWL E	Black	580	108 in.	10
295961	CFOR-105 DWL E	Black	580	36 in.	10
295963	CFOR-105 DWL E	Black	580	48 in.	10
295965	CFOR-105 DWL E	Black	580	60 in.	10
295967	CFOR-105 DWL E	Black	580	72 in.	10
295969	CFOR-105 DWL E	Black	580	84 in.	10
295971	CFOR-105 DWL E	Black	580	96 in.	10
295972	CFOR-105 DWL E	White	501	108 in.	10
295960	CFOR-105 DWL E	White	501	36 in.	10
295962	CFOR-105 DWL E	White	501	48 in.	10
295964	CFOR-105 DWL E	White	501	60 in.	10
295966	CFOR-105 DWL E	White	501	72 in.	10
295968	CFOR-105 DWL E	White	501	84 in.	10
295970	CFOR-105 DWL E	White	501	96 in.	10

YKK® and ZIPLON® are registered trademarks of YKK Corporation in Japan and other countries/regions.



279813

YKK® ZIPPY COOL®

This two-part product includes a cleaner and lubricant. It is specially formulated for use on all types of metal and plastic zippers. The patented push/pull dispenser brush removes harmful dirt, sand and salt. After rinsing, it leaves a protective film on the zipper. Lubrication on the zipper will not flake or cause jams, even in extreme temperatures. It contains no silicone or paraffin.

ITEM #	DESCRIPTION	STANDARD PACKAGE
279813	Zippy Cleaner and Lubricant	1

YKK® and ZIPPY COOL® are registered trademarks of YKK Corporation in Japan and other countries/regions.



279800

Zipzap Lubricants

Extends the life of the zipper. Cleans and lubricates plastic, nylon, and metal zippers, without collecting dirt, sand or organic residue. The wax provides smooth zipper teeth operation, and the fluid cleans and lubricates the zipper action.

ITEM #	DESCRIPTION	PUT UP	STANDARD PACKAGE
279800	Fluid	2 oz.	1



202475

Awl – Automatic

The No. 413 Automatic Awl is used for sewing leather and canvas. This tool carries a spool of thread on the handle and includes an extra curved needle and wrench.

ITEM #	STYLE #	DESCRIPTION	STANDARD PACKAGE
202475	413	Automatic Awl	1
202476	413N-5	Automatic Awl Straight Needle	1
202479	413N-8	Automatic Awl Straight Needle	1



202476



202469

Awl – Heavy-Duty Scratch No. 4

Scratch Awl comes with a plastic handle and quality steel blade. It's used to mark surfaces for cutting and fabrication and for holding down fabric while working.

ITEM #	STYLE #	BLADE SIZE	STANDARD PACKAGE
202469	1	2-1/2 in.	1
202470	2	3-1/2 in.	1



248232

Binder

This inexpensive universal binder attachment is ideal for use with 3/4 inch and 1 inch acrylic bindings. It comes with a universal plate assembly so it fits almost any commercial sewing machine. The opening is wide enough so that two edge turn bias cut binding slides smoothly and effortlessly through the attachment.

ITEM #	STYLE #	DESCRIPTION	SIZE	STANDARD PACKAGE	TYPE
248231	100LS	Universal Binder with Plate	3/4 in.	1	Plain
248232	100LS	Universal Binder with Plate	1 in.	1	Plain



275441

DrillSteady Drill For Stainless Tubing

DrillSteady uses 9/64 inch drill bit for No. 8 screw or fastener. Unique design allows drilling on installed frames, corners, or anywhere.

ITEM #	STYLE #	STANDARD PACKAGE
275441	3587	1



216134

DOT® Snapmaster M840

The M840 hand press incorporates many features of bench and foot presses in a portable and cost-effective tool. Ideal for installing DOT® Durable™, Pull-The-Dot®, Lift-The-Dot® and curtain fasteners. Replacement parts available.



216133

ITEM #	STYLE #	DESCRIPTION	FOR USE WITH	STANDARD PACKAGE
216116	4201	Clinch Plate	16506 DOT Lift-The-Dot Clinch Plate	1
216115	4101	Cutting Punch	16205 DOT Lift-The-Dot Socket	1
275114	89-9054	Die Tool		1
275118	89-9064	Die Tool		1
275113	89-9053	Punch Tool		1
275117	89-9063	Punch Tool		1
216136	4405	Setting Die Cap	18100 DOT Pull-The-Dot Button	1
216134	4203	Setting Die	78403 Curtain Fastener Eyelet	1
216118	4401	Setting Die	16506 DOT Lift-The-Dot Clinch Plate	1
216125	4402	Setting Die	78505 Curtain Fastener Washer	1
216130	4403	Setting Die	10127/10128 DOT Durable Button	1
216132	4404	Setting Die	10412 DOT Durable Eyelet	1
216138	4701	Setting Die	00800 #1 Grommet	1
216133	4103	Setting Punch	78403 Curtain Fastener Eyelet	1
216117	4301	Setting Punch	16205 DOT Lift-The-Dot Socket	1



216110

ITEM #	STYLE #	DESCRIPTION	FOR USE WITH	STANDARD PACKAGE
216124	4302	Setting Punch	78403 Curtain Fastener Eyelet	1
216129	4303	Setting Punch	10224 DOT Durable Socket	1
216131	4304	Setting Punch	10370 DOT Durable Stud	1
216135	4305	Setting Punch	18201 DOT Pull-The-Dot Socket	1
216137	4700	Setting Punch	00900 #1 Grommet	1
216110		Snapmaster Hand Press M840		1

DOT®, Lift-The-Dot® and Pull-The-Dot® are registered trademarks of Scovill, Inc. Durable™ is a trademark of Scovill, Inc.



275458

Hand Tools For DOT® Common Sense® / Lift-The-Dot® Fasteners

Trivantage® is pleased to introduce our new DOT Common Sense / Lift-The-Dot hand punch, designed and built in the USA for our industry professionals. The new hand punch includes cutting dies for both the Common Sense and Lift-The-Dot fasteners.

Dies can be changed with Allen wrenches (included) and can be sharpened as needed. A molded, hard case is included.

This new hand punch is made of billet aluminum and has an ergonomically designed handle. The cutting dies are machined from 4140 hardened steel making them extremely strong and durable.

The hand punch includes a two-year manufacturer’s warranty.

WARRANTY	2-Year
-----------------	--------

ITEM #	STYLE #	DESCRIPTION	MATERIAL	STANDARD PACKAGE
275469	43322	Common Sense Die Assembly Replacement Center Punch Set Screw 6-32 x 0.125"	Stainless Steel	1
275468	43764	Common Sense Die Assembly Replacement Center Punch		1
275467	43320	Common Sense Die Assembly Replacement Punch Pin Set Screw		1
275466	43317	Common Sense Die Assembly Replacement Punch Pin Set		1
275465	43302	Common Sense Die Assembly		1
275460	43324	Common Sense Punch Assembly Replacement Compression Spring	Stainless Steel	1
275464	43326	Common Sense Punch Assembly Replacement Nut 8-32 Nylock	Stainless Steel	1
275461	43325	Common Sense Punch Assembly Replacement Nut Set 10-24 Nylock	Stainless Steel	1
275462		Common Sense Punch Assembly Replacement Screw Set 10-24 x 1-1/4"	Stainless Steel	1
275463	43323	Common Sense Punch Assembly Replacement Shoulder Bolt 8-32 x 1.188"	Stainless Steel	1
275459	43328	Common Sense Punch Assembly		1
275458	43000	Fastener Tool with Case		1
275474	43310	Hand Tool Set Replacement Hard Case		1
275473	43763	Lift-The-Dot Assembly Replacement Center Punch		1
275472	43320	Lift-The-Dot Die Assembly Replacement Punch Pin Screw Set		1
275471	43317	Lift-The-Dot Die Assembly Replacement Punch Pin Set		1
275470	43303	Lift-The-Dot Die Assembly		1

DOT®, Common Sense® and Lift-The-Dot® are registered trademarks of Scovill, Inc. Trivantage® is a registered trademark of Glen Raven, Inc.

Hand Tools For DOT® Common Sense® Fasteners



216045



216047

ITEM #	STYLE #	DESCRIPTION	FOR	STANDARD PACKAGE
216045	C4-450	Common Sense Fastener Cutter	Use with cutting pad (#223449). For BS-78403 (No. 400) Eyelet.	1
223509	9578	Common Sense Machine Die		1
216047	QTTL	Common Sense Quick Turn Lock Driver	Use with 1/4 in. cordless screw driver or drill motor to install XX-78315, XX-78324, XX-78325, X8-78324, XB-78324 or XB-78325 turn buttons.	1
216048	QTTL-N	Common Sense Quick Turn Lock Driver	Use with 1/4 in. cordless screw driver or drill motor to install 404, 405, XB-404 or XB-405 turn buttons.	1
275584	89-9908	Screwdriver for Curtain Fastener		1

DOT® and Common Sense® are registered trademarks of Scovill, Inc.

Hand Tools For DOT® Lift-The-Dot® Fasteners



275501



248161



275502

ITEM #	STYLE #	DESCRIPTION	FOR	STANDARD PACKAGE
275573	9940	Bench Die for XB-16358 Single Eyelet		1
275576	9432	Die for 90-16506		1
275481	16349	Die for BS-16349		1
275480	16501	Die for BS-16501		1
275501	9951E	Hand Cutting Punch for XX-16205/XX-16206	Use with cutting pad (#223449). For XX-16205 socket with chisel point.	1
275575	171	Hand Punch for BS-78332/BS-78333/BS-16349	Use with cutting pad (#223449).	1
248162	71-177	Lift-The-Dot Cutting Punch	For 90-16349, 91-78322 and 91-78333.	1
248161	L6-9951	Lift-The-Dot Hand Punch		1
275502	169B	Screwdriver for Lift-The-Dot Studs		1

DOT® and Lift-The-Dot® are registered trademarks of Scovill, Inc.

Hand Tools For DOT® Durable™ or Glove Button Fasteners



275504



275564

ITEM #	STYLE #	DESCRIPTION	FOR	STANDARD PACKAGE
275583	1482	Die for Baby Durable 12105 Cap		1
275587	1488	Die for Baby Durable 12404/12405/12407 Post		1
248160	164H	Hand Punch		1
275504	169N	Phillips Head Screwdriver for Durable DOT	Use with X8-10301, X8-10302, XX-10362, X8-10393, XB-10393, X8-10704, XX-10708 and X8-10934 studs.	1
275592	ADAPPHIL	Phillips Screw Stud Adapter		1
275588	9323	Punch for Baby Durable 12205/12206 Socket		1
275589	9332	Punch for Baby Durable Eyelets		1
275507	9772	Setting Die for Baby Durable 12302/12303		1
275564	164	Setting Punch for Durable DOT		1

DOT® is a registered trademark of Scovill, Inc. Durable™ is a trademark of Scovill, Inc.

Hand Tools for Fasnap® Fasteners

For setting Fasnap One-Way-Lift® socket/washers, turn fastener eyelets/washers and SnapFast® products. Contains a turn fastener driver.

ITEM #	STANDARD PACKAGE
275612	1

FASNAP®, One-Way-Lift® and SnapFast® are registered trademarks of The FASNAP Corporation.



248133

Fabric Fastener Kit

Used for setting 10128, 10224, 10370 and 10412 DOT® Durable™ fasteners.

ITEM #	STYLE #	DESCRIPTION	STANDARD PACKAGE
248133	USC1T	Nos. 9896 and 9897 setting tools (2 pieces each bag)	1

DOT® is a registered trademark of Scovill, Inc. Durable™ is a trademark of Scovill, Inc.



256071

Hand Press No. M-380E

Hand press for DOT® fasteners.

ITEM #	STYLE #	HEIGHT	STANDARD PACKAGE	WEIGHT
256071	M-380E	12"	1	7 lbs.

DOT® is a registered trademark of Scovill, Inc.



223512



223510

Hand Press No. M-380E – Dies For DOT® Durable™ Fasteners

ITEM #	STYLE #	FOR USE WITH	STANDARD PACKAGE
223512	1412	BS-10370 Stud	1
223507	1407	BS-10412 eyelet	1
223501	1401	X2-10128/X2-10127 Button	1
223510	1410	XB-10224 Socket	1
275580	9557	XB-10342 Stud	1

DOT® is a registered trademark of Scovill, Inc. Durable™ is a trademark of Scovill, Inc.

Hand Press No. M-380E – Dies For DOT® Lift-The-Dot® Fasteners

ITEM #	STYLE #	FOR USE WITH	STANDARD PACKAGE
223557	1457	BS-16509 washer	1
223556	1456	XB-16358/XB-16359 stud	1
223554	1454	XX-16205 socket	1



223560



223558



275577



248113



248111



248112



248110

Hand Press No. M-380E – Dies for DOT® Pull-The-Dot® Fasteners

ITEM #	STYLE #	FOR USE WITH	STANDARD PACKAGE
223560	8059	XX-18201 socket	1
223558	9758	XE-18100 button	1
275577	9760	BS-18303 stud	1

Pliers – VISE® Pliers Kit for DOT® Durable™

ITEM #	STYLE #	DESCRIPTION	FOR USE WITH	STANDARD PACKAGE
248113	MT480B	Metal Anvil Die	BS-10412 Eyelet #MT480B	1
248111	MT479B	Metal Anvil Die	X2-10128 Button #MT479B	1
248114	MT489A	Metal Clincher Die	BS-10370 Stud #MT489A	1
248112	MT482A	Metal Clincher Die	XB-10224 Socket #MT482B	1
248109		VISE Pliers and Dies Kit		1
248110	T310R	VISE Pliers		1

248109 - Kit includes: 2– No. 100 VISE Pliers; 1– No. M-102 Metal Clincher Die for No. XB-10224 Socket; 1– No. M-103 Metal Anvil Die for No. BS-10412 Eyelet; 1– No. M-104 Metal Clincher Die for No. BS-10370 Stud; 1– No. M-105 Metal Anvil Die, with Ring, for X2-10128 Button.

VISE® is a registered trademark of Irwin Tools. DOT® is a registered trademark of Scovill, Inc. Durable™ is a trademark of Scovill, Inc.



275411



275401



275412



275413



275415



275400

Pres-N-Snap®

ITEM #	DESCRIPTION	FOR USE WITH	STANDARD PACKAGE
275411	Baby Durable Die Set		1
275398	Bench Mount		1
275429	Die Set	DOT Speedy Rivet #11L-Small HPR/HPRF	1
275401	Die	#10128 Button	1
275404	Die	#10224 Socket	1
275428	Die	#10342 Gypsy Stud	1
275402	Die	#10370 Stud	1
275397	Die	#10379 Stud	1
275403	Die	#10412 Eyelet	1
275412	Die	#BS16509 Washer	1
275413	Die	#XB16358 Stud	1
275399	Frame		1
275417	Handle		1
275427	Lever		1
275405	M-2700 Rubber Ring	DOT Durable Dies	1
275415	Plunger		1
275400	Pres-N-Snap Complete Tool		1
275409	Rubber O-Ring		10
248172	Rubber O-Ring	#12 Stud Black	10
275416	Spring		1
275423	Stayput Shock Cord Clip (SCC/SCR)		1

275400 - Includes dies for 10128, 10224, 10370, 10412 durable fasteners – plus die for No. 1 grommet with plain washer.

Pres-N-Snap® is a registered trademark of Hoover Products. DOT® is a registered trademark of Scovill, Inc. Durable™ is a trademark of Scovill, Inc.



275420



275425

Pres-N-Snap® – Grommet Dies

ITEM #	DESCRIPTION	FOR USE WITH	STANDARD PACKAGE
275422	Die Set	No. 0 Plain Grommets	1
275434	Die Set	No. 0 Self-Piercing Grommets	1
275421	Die Set	No. 00 Plain Grommets	1
275432	Die Set	No. 1 Grommets with Spur Washers	1
275419	Die Set	No. 1 Plain Grommets	1
275431	Die Set	No. 1 Self-Piercing Grommets	1
275420	Die Set	No. 2 Plain Grommets	1
275430	Die Set	No. 2 Self-Piercing Grommets	1
275435	Hole Punch	No. 00 Grommets	1
275425	Hole Punch	No. 1 Grommets	1
275426	Hole Punch	No. 2 Grommets	1

Pres-N-Snap® is a registered trademark of Hoover Products. DOT® is a registered trademark of Scovill, Inc. Durable™ is a trademark of Scovill, Inc.



275590



275595



275596

Quick-Fit™ Tool Kit

Quick-Fit holding tool snaps on to existing studs and provides a quick and easy way to hold material while fitting — no clamps necessary. Quick-Fit holds material in place on the holding pin, especially on a windy day. Quick-Fit release tool easily installs and removes the holding pin from the stud. Quick-Fit tools are great for fitting with material and also holding paper or plastic when making a pattern. Can be used over and over on job after job. Can be used on boat cockpit covers, side curtains, enclosures, console covers, carpet, pickup truck tonneau covers, etc. Quick-Fit holding tools accurately mark the fabric cover where the snap sockets are to be placed.

Quick-Fit Tool Kit includes 25 Quick-Fit Caps, 50 Quick-Fit Sockets and 1 Quick-Fit Release Tool.

ITEM #	DESCRIPTION	STANDARD PACKAGE
275590	Tool Kit	1
275591	Caps	25
275595	Sockets with Points	25
275596	Release Tool	1

Quick-Fit™ is a trademark of Quick Fit Canvas Tools.



248185

Fasnap® PM5 Grommet Machine

The PM5 machine is an industry standard bench-mounted machine. It is made of tough ductile iron and has a deep throat with a longer padded handle. This machine uses standard 3/8 inch diameter shank dies that set self-piercing grommets up to size 300 (#4), and snap fasteners in one motion, swiftly and efficiently. Throat depth: 4-3/4 inch. Dies sold separately

ITEM #	DESCRIPTION	STANDARD PACKAGE
248185	Fasnep PM5 Grommet Machine	1

FASNAP® is a registered trademark of The FASNAP Corporation.



256430

Hole Punch

Excellent for punching screw holes in aluminum molding, without leaving burred edges.

Makes a 1/8 inch or 3/16 inch hole and are easily changed from standard 1/8 inch hole size to 3/16 inch. Punch is constructed from high-quality tool steel used in commercial high-production punch press dies. Body is lightweight, die cast aluminum with rust-resistant, nickel-plated steel handles and parts. Features a non-slip cushion handle grip.

ITEM #	STYLE #	SIZE	STANDARD PACKAGE
256430	HP18K	1/8 in. to 3/16 in. holes	1



248501



248502



248506

Engel Hot Knife

Cuts and seals the edges of synthetic fabrics to prevent fraying. The knife can be used with a cutting foot to eliminate the need for a special cutting base or surface. Designed for intermittent operation, the knife heats up in six to eight seconds. Temperature is controlled by a convenient trigger switch. All items are sold separately.

Use in well ventilated areas.

ITEM #	STYLE #	DESCRIPTION	STANDARD PACKAGE
248501	C851	Engel HSG-O Electric Hot Knife Cutter	1
248502	C852	Engel Hot Knife Blade 100R	1
248506	C856	Engel Hot Knife Cutting Foot	1



252248

Hand Notcher

Fast and easy cutting. Notcher makes a clean 30°, "V"-shaped cut in sheet metal. 13/16 inch maximum throat depth. Upper cutting jaw is drop forged, high-impact alloy steel. Hook design of cutting jaw facilitates notching to desired depth without slippage. Nickel plated and black oxide finish. Blue grips.

ITEM #	STYLE #	LENGTH	STANDARD PACKAGE	WEIGHT
252248	N1	8 in.	1	1 lb.



256095



256094



256098

Multi-Duty Hand Press No. W-1

This Osborne high quality hand machine cuts fabric and covers buttons. It uses 2 piece dies and short cutters. This hand machine has a reinforced frame and handle. It bolts to a table for added stability. The machine handles between 80-120 buttons per hour. It can also be used to set snaps, grommets and ventilators.

ITEM #	STYLE #	DESCRIPTION	STANDARD PACKAGE
256095	W-1H	Handle	1
256094	W-1	Osborne Multi-Duty Hand Press #W-1	1
256097	W-1PL	Plate	1
256098	W-1 SPRING	Top Spring	1



256298

Multi-Duty Hand Press No. W-1 – Dies

Dies for setting snaps, grommets, and ventilators for the Osborne Multi-Duty Hand Press #W-1 (Item# 256094).



256299



256333



256334

ITEM #	STYLE #	DESCRIPTION	SIZE	SIZE HOLE	STANDARD PACKAGE
216491	WDISGRC2-75837	Setting Die and Hole Cutter #2 for Spur Washer	2	3/8 in.	1
256298	WDISN201	Snap Die #20	20		1
256299	WDIGRC00	Setting Die #00 For Plain Washer	00		1
256300	WDIGRC0	Setting Die #0 For Plain Washer	0		1
256301	WDIGRC1	Setting Die #1 For Plain Washer	1		1
256302	WDIGRC2	Setting Die #2 For Plain Washer	2		1
256303	WDIGRC3	Setting Die #3 For Plain Washer	3		1
256304	WDIGRC4	Setting Die #4 For Plain Washer	4		1
256305	WDIGRC5	Setting Die #5 For Plain Washer	5		1
256306	WDIGRC6	Setting Die #6 For Plain Washer	6		1
256312	WDIGRC12	Setting Die #12 For Plain Washer	12		1
256315	WDIGRC15	Setting Die #15 For Plain Washer	15		1
256320	WDISGRC0	Setting Die #0 for Spur Washer	0		1
256321	WDISGRC1	Setting Die #1 for Spur Washer	1		1
256322	WDISGRC2	Setting Die #2 for Spur Washer	2		1
256323	WDISGRC3	Setting Die #3 for Spur Washer	3		1
256324	WDISGRC4	Setting Die #4 for Spur Washer	4		1
256325	WDISGRC5	Setting Die #5 for Spur Washer	5		1
256330	WDISGRC10	Setting Die #10 for Spur Washer	10		1
256331	WDIV1	Ventilator Die 1 in.			1
256333	WDIVS	Ventilator Die 3/4 in.			1
256334	684	Ventilator 3/4 in.			1



255250

Pliers – Fabric Pulling Pliers No. 250

No. 250 plier is made with a hammer jaw. The hammer acts as a lever if a strong pull is required. This is an excellent tool for stretching canvas and leather as well as webbing. It is ideal for pulling fabric over frames.

ITEM #	STYLE #	LENGTH	STANDARD PACKAGE
255250	250	8-3/4 in.	1



256440

Revolving Punch No. 155

Used to punch holes in soft fabrics and leather goods. The frame is made of highly polished forged steel. The cutting tubes are hand turned from high carbon tool steel and threaded to allow easy replacement.

ITEM #	STYLE #	LENGTH	STANDARD PACKAGE	WEIGHT
256440	155	8-1/2 in.	1	1 lb.



256452

Revolving Punch No. 155 – Cutting Tube Kit

ITEM #	STYLE #	STANDARD PACKAGE
256452	155T	1



256442

Revolving Punch No. 155 – Cutting Tubes

ITEM #	STYLE #	SIZE	STANDARD PACKAGE
256441	155T-1	3/32 in.	1
256442	155T-2	7/64 in.	1
256443	155T-3	1/8 in.	1
256444	155T-4	5/32 in.	1
256445	155T-5	11/64 in.	1
256446	155T-6	3/16 in.	1



256448

Revolving Punch No. 155 – Punch Anvil

A copper replacement base for the No. 155 Revolving Punch. The soft copper composition of this base is gentle on dies to provide longer service life.

ITEM #	STYLE #	STANDARD PACKAGE
256448	155A	1



268120

Sewing Kit

Exclusively from Trivantage®, our Sewing Kit puts sewing solutions right at your fingertips. This durable and useful kit can be used on a variety of fabrics and projects. The kit contains:

- 1 small curved scissor – Makes working on sewing machine threads much easier.
- 1 bent scissor – Great for cutting small threads and material that is close to a sewing machine needle.
- 1 solid ball seam ripper – This heavy-duty alternative to plastic seam rippers is primarily used for window replacements.
- 1 staple remover – Removes staples from fabric or upholstery easily and without pulls. Each tool is made from handcrafted stainless steel.

ITEM #	STANDARD PACKAGE
268120	1

Trivantage® is a registered trademark of Glen Raven, Inc.



214301

Thread Nippers

ITEM #	FULL LENGTH	STANDARD PACKAGE
214301	4-1/2 in.	6



266225

Shears – WISS® Upholstery, Carpet And Fabric Shears

Hot drop-forged, polished blades. One blade is ground to a knife-edge.

To attain the extra sharp knife edge, the cutting edge of the top blade is ground to a greater angle than regular shears. For this reason they will require more frequent sharpening than conventional Wiss Inlaid® Trimmers. However, a simple resharpening procedure will restore the edge quickly and easily. Do not stone the inside of this blade or the opposing blade.

ITEM #	STYLE #	FULL LENGTH	LENGTH OF CUT	STANDARD PACKAGE
266225	1225	10-1/4 in.	4-3/4 in.	1
266226	1226	12-1/4 in.	6-1/8 in.	1

Wiss® and Inlaid® are registered trademarks of Cooper Industries, Inc.



266022

Shears – WISS® Upholstery, Drapery, Carpet And Fabric Shears – Heavy Duty

With thick, heavy-duty blades to cut through multiple layers and tough material. Hot drop-forged, polished standard edge blades.

To attain the extra sharp knife edge, the cutting edge of the top blade is ground to a greater angle than regular shears. For this reason they will require more frequent sharpening than conventional Wiss Inlaid® Trimmers. However, a simple resharpening procedure will restore the edge quickly and easily. Do not stone the inside of this blade or the opposing blade.

ITEM #	STYLE #	FULL LENGTH	LENGTH OF CUT	STANDARD PACKAGE
266019	20W	10-1/4 in.	4-3/4 in.	1
266022	22W	12-1/4 in.	6-1/8 in.	1

Wiss® and Inlaid® are registered trademarks of Cooper Industries, Inc.



266227

Shears – Ergonomic Shears

Ergonomic Shears have an extended bottom ring that allows you to use all four fingers and wear a glove, if needed. By using your whole hand, you have more comfort, less strain on the wrist and added cutting leverage. This bent trimmer is made from high-carbon steel with a knife edge and blue soft-coated handle for extra comfort. A chrome-over-nickel plating inside and out provides double rust prevention.

ITEM #	STYLE #	FULL LENGTH	STANDARD PACKAGE
266227	210LRK	10 in.	1



266027

Shears – WISS® Industrial Shears

Hot drop-forged, nickel-plated shears with standard edge blades.

To attain the extra sharp knife edge, the cutting edge of the top blade is ground to a greater angle than regular shears. For this reason they will require more frequent sharpening than conventional Wiss Inlaid® Trimmers. However, a simple resharpening procedure will restore the edge quickly and easily. Do not stone the inside of this blade or the opposing blade.

ITEM #	STYLE #	FULL LENGTH	LENGTH OF CUT	STANDARD PACKAGE
266027	27	7-1/2 in.	3-1/8 in.	1
266028	28	8-1/8 in.	3-3/4 in.	1

Wiss® and Inlaid® are registered trademarks of Cooper Industries, Inc.



266020

Shears – WISS® Industrial Shears – Heavy Duty

Hot drop-forged, polished standard edge blades, with black handles. Style 20 LH is the left-handed version.

To attain the extra sharp knife edge, the cutting edge of the top blade is ground to a greater angle than regular shears. For this reason they will require more frequent sharpening than conventional Wiss Inlaid® Trimmers. However, a simple resharpening procedure will restore the edge quickly and easily. Do not stone the inside of this blade or the opposing blade.

ITEM #	STYLE #	FULL LENGTH	LENGTH OF CUT	STANDARD PACKAGE
266020	20	10-1/4 in.	4-3/4 in.	1
266021	20LH	10-1/4 in.	4-3/4 in.	1

Wiss® and Inlaid® are registered trademarks of Cooper Industries, Inc.



266016

Shears – WISS® Shop Shears

Serrated bladed shears.

ITEM #	STYLE #	FULL LENGTH	STANDARD PACKAGE
266016	W912	10 in.	1

Wiss® is a registered trademark of Cooper Industries, Inc.



266233

Shears – Kretzer®

Kretzer Scissors is the leading German scissors manufacturer. The quality and durability of these shears are only two of many aspects associated with German craftsmanship.

ITEM #	STYLE #	DESCRIPTION	FULL LENGTH	STANDARD PACKAGE
266232	73725	Trivantage® Shop Shears	10 in.	1
266233	K22	Trim Shears	12 in.	1
266234	K20	Trim Shears	10 in.	1
266235	KRE764425	Pinking Shears	10-1/2 in.	1
266236	72020	Trivantage® Trim Shears	8 in.	1

Kretzer® is a registered trademark of Johann Kretzer GmbH & Co.



268100

Staple Remover

Forged from 4140 alloy tempered steel.

ITEM #	STYLE #	STANDARD PACKAGE
268100	124	1



275599

Top-Snapper®

Built of marine-grade stainless steel with an easy to grip rubberized handle, makes snapping your canvas boat top into place easy and convenient. Just slide the ingenious, patented Top-Snapper over the snap, pull it into place, and snap it shut.

ITEM #	STYLE #	STANDARD PACKAGE
275599	008.1	1

Top-Snapper® is a registered trademark of Ironwood Pacific Inc.





248219

Cutter – Tubing

Excellent portable tubing cutter for aluminum. Stainless steel cutting wheel sold separately.

ITEM #	STYLE #	DESCRIPTION	STANDARD PACKAGE
248219	TC312	Tube Cutter	1
248221	75046	Stainless Steel Cutting Wheel	1



248221



216400

Cutter – Side Cutter

Typically used for plain and tooth grommet washers. For best results use Trivantage® Cutting Pad (Item no. 223449). Do not use with steel head hammers.

ITEM #	STYLE #	SIZE HOLE	STANDARD PACKAGE
216400	00	3/16 in.	1
216401	0	1/4 in.	1
216402	1	9/32 in.	1
216403	2	3/8 in.	1
216404	3	7/16 in.	1
216405	4	1/2 in.	1
216406	5	5/8 in.	1
216407	6	3/4 in.	1
216408	7	7/8 in.	1
216409	8	1 in.	1

Trivantage® is a registered trademark of Glen Raven, Inc.



216504

Cutter – Special Cutter

Typically used for rolled rim spur grommet washers. For best results use Trivantage® Cutting Pad (Item no. 223449). Do not use with steel head hammers.

ITEM #	STYLE #	SIZE HOLE	STANDARD PACKAGE
216499	00	3/16 in.	1
216501	0	1/4 in.	1
216502	1	9/32 in.	1
216503	2	3/8 in.	1
216504	3	7/16 in.	1
216505	4	1/2 in.	1
216506	5	5/8 in.	1
216507	6	3/4 in.	1
216508	7	7/8 in.	1
216509	8	1 in.	1

Trivantage® is a registered trademark of Glen Raven, Inc.



223205

Setting Die For Plain And Tooth Grommets And Washers

For inserting round grommets. Made of superior grade drop forged steel or hardened steel tool.

Setting Dies are guaranteed against defects in material and workmanship, but this guarantee is not intended to cover tools against wear, over-strain, steel hammering, etc. To obtain maximum life of tools use Dead Blow Hammer, Rawhide Mallet, Cutting Pad and strike at 90 degree angle.

ITEM #	STYLE #	DESCRIPTION	STANDARD PACKAGE
223200	00	Stimpson	1
223201	0	Stimpson	1
223202	1	Stimpson	1
223203	2	Stimpson	1
223204	3	Stimpson	1
223205	4	Stimpson	1
223206	5	Stimpson	1
223207	6	Stimpson	1
223208	2J	Stimpson	1
223410	00	Osborne #216	1
223411	0	Osborne #216	1
223412	1	Osborne #216	1
223413	2	Osborne #216	1
223414	3	Osborne #216	1
223415	4	Osborne #216	1
223416	5	Osborne #216	1
223417	6	Osborne #216	1



223301

Setting Die For Rolled Rim Grommets And Spur Washers

For inserting round grommets. Made of superior grade drop forged steel or hardened steel tool.



223423

Setting Dies are guaranteed against defects in material and workmanship, but this guarantee is not intended to cover tools against wear, over-strain, steel hammering, etc. To obtain maximum life of tools use Dead Blow Hammer, Rawhide Mallet, Cutting Pad and strike at 90 degree angle.

ITEM #	STYLE #	DESCRIPTION	STANDARD PACKAGE
223301	0	Stimpson	1
223302	1	Stimpson	1
223303	2	Stimpson	1
223304	3	Stimpson	1
223305	4	Stimpson	1
223306	5	Stimpson	1
223307	6	Stimpson	1
223420	0	Osborne #217	1
223421	1	Osborne #217	1
223422	2	Osborne #217	1
223423	3	Osborne #217	1
223424	4	Osborne #217	1
223425	5	Osborne #217	1
223426	6	Osborne #217	1
223427	7	Osborne #217	1
223428	8	Osborne #217	1



216490

Punch Kit – Self-Centering

This handy and versatile kit contains a threaded handle with self-centering pointed plunger. Designed to accommodate nine interchangeable threaded cutting tubes in diameter sizes of 1/4 inch, 5/16 inch, 3/8 inch, 7/16 inch, 1/2 inch, 5/8 inch, 3/4 inch, 7/8 inch and 1 inch. The punches in this set will cleanly cut fabric, leather, rubber, paper, plastic and other soft materials.

ITEM #	STYLE #	STANDARD PACKAGE
216490	K156	1



248102

Grommet Kit – Home

A complete and inexpensive kit for household use. Each kit consists of a grommet die, a cutting punch, 3 dozen grommets and washers, a small cutting board and complete instructions.

ITEM #	STYLE #	GROMMET SIZE	STANDARD PACKAGE	WEIGHT
248100	0	1/4 in.	1	1-1/2 lbs.
248101	1	9/32 in.	1	1-1/2 lbs.
248102	2	3/8 in.	1	1/3/4 lbs.
248103	3	7/16 in.	1	1/3/4 lbs.
248104	4	1/2 in.	1	1/3/4 lbs.



237001

Hammer – Dead Blow

Quick-change threaded faces are molded in one piece without metal plugs. Shot-filled heads reduce rebound and increase impact. Replacement faces in white nylon, medium red, extra hard yellow and tough brown polyurethane.

ITEM #	STYLE #	DESCRIPTION	COLOR	SIZE	STANDARD PACKAGE	WEIGHT
237000	DB175	Dead Blow Hammer		1-3/4 in.	1	2 lbs.
237001	DB250	Dead Blow Hammer		2-1/2 in.	1	4 lbs.
237002	175HF	Face Replacement	White	1-3/4 in.	1	
237003	250HF	Face Replacement	White	2-1/2 in.	1	
237004	175XF	Face Replacement	Yellow	1-3/4 in.	1	
237005	250TF	Face Replacement	Brown	2-1/2 in.	1	



250801

Mallet/Maul – Rawhide

ITEM #	STYLE #	DESCRIPTION	STANDARD PACKAGE	WEIGHT
250804		Mallet Handle	1	
250807	393-4RR	Mallet Leather Refill	1	
250806	393-3RR	Mallet Leather Refill	1	
250808	393-6RR	Mallet Leather Refill	1	
250809	196-2	Mallet	1	
250800	393-2	Mallet	1	2 lbs.
250801	393-3	Mallet	1	2-12/ lbs.
250802	393-4	Mallet	1	4-1/2 lbs.
250803	393-6	Mallet	1	6 lbs.



237015

Hammer – Rawhide With Split Head – No. 395

Ideal for use with arch punches, grommet dies or wherever a cushioned blow is desired. No trouble to replace faces. Just loosen the safety nut, remove worn face, insert replacement and tighten.

ITEM #	STYLE #	DIAMETER OF FACE	SIZE	STANDARD PACKAGE	WEIGHT
237013	395-1	1-1/4 in.	1	1	1-1/2 lbs.
237014	395-2	1-1/2 in.	2	1	2 lbs.
237015	395-3	1-3/4 in.	3	1	3 lbs.



237021

Hammer – Rawhide Replacement Heads

ITEM #	STYLE #	SIZE	STANDARD PACKAGE
237020	395F-1	1	1
237021	395F-2	2	1
237022	395F-3	3	1



223449

Cutting Pad

Made of a special formula resilient vinyl plastic, these tough cutting pads are ideal for use with Osborne Punches. They are long wearing and can be used on both sides. Use on a solid base for best results.

ITEM #	STYLE #	MATERIAL	SIZE	STANDARD PACKAGE
223449	603	Urethane	10 in. x 10 in. x 3/8 in.	1



237016

Hammer – Tack

Magnetic.

ITEM #	STYLE #	DESCRIPTION	STANDARD PACKAGE
237016	33	Magnetic Tack Hammer	1



205304

Bendarc Quick-Switch Bender

The Bendarc bends a 6, 8, 10 or 12 inch radius on either 7/8, 1, or 1-1/4 inch OD aluminum or stainless steel marine tubing. Designed for wall or bench mounting. Bends are formed using a long handle for leverage and with the aid of body weight. The Bendarc gives strong bends with smooth, rounded corners. Constructed of boiler plate steel with bearing supported roller. Rollers are high-density polymer for mar resistant contact with fine tubing finishes.

Interchangeable forming blocks, clamp blocks and rollers are also available to convert from a 6 inch radius to 8 inch or 10 inch, and a 7/8 inch OD tube to 1 inch OD. Switch sizes easily and quickly with only an Allen wrench and a 1/2 inch socket. Once forming block replacement is installed, only a finger tight adjustment of a nut on the clamp block is required.

Items are drop ship only.

ITEM #	DESCRIPTION	FOR	RADIUS	STANDARD PACKAGE
205348	Bearing Support Roller	1 in. round tubing		1
205349	Bearing Support Roller	1 in. square tubing		1
205347	Bearing Support Roller	1-1/4 in. round tubing		1
205346	Bearing Support Roller	7/8 in. round tubing		1
205344	Clamp Black Assembly	1 in. round tubing		1
205345	Clamp Black Assembly	1 in. square tubing		1
205342	Clamp Black Assembly	7/8 in. round tubing		1
205350	Clamp			1
205340	Form Block	1 in. round tubing	10 in.	1
205338	Form Block	7/8 in. round tubing	10 in.	1
205343	Form Block	1 in. round tubing	12 in.	1
205341	Form Block	7/8 in. round tubing	12 in.	1
205332	Form Block	1 in. round tubing	6 in.	1
205330	Form Block	7/8 in. round tubing	6 in.	1
205336	Form Block	1 in. round tubing	8 in.	1
205334	Form Block	7/8 in. round tubing	8 in.	1
205352	Pull Down Handle			1
205337	Steel Encased Form Block	1 in. square tubing	10 in.	1
205321	Tube Bender With Steel Encased Form Block	1 in. square tubing	10 in.	1
205319	Tube Bender With Steel Encased Form Block	1 in. square tubing	12 in.	1
205320	Tube Bender	1 in. tubing	10 in.	1
205313	Tube Bender	1-1/4 in. tubing	10 in.	1
205318	Tube Bender	7/8 in. tubing	10 in.	1
205315	Tube Bender	1 in. tubing	12 in.	1
205304	Tube Bender	1 in. tubing	6 in.	1
205310	Tube Bender	7/8 in. tubing	6 in.	1
205316	Tube Bender	1 in. tubing	8 in.	1
205314	Tube Bender	7/8 in. tubing	8 in.	1



205362

Crownarc Crown Bender

Bends 7/8 inch, 1 inch and 1-1/4 inch outside diameter marine tubing using the same dies. The crown radius is adjustable from 30 inch minimum to infinity. The only Crownarc with gear drive; Crownarc's crank turns both lower wheels and "takes a bigger bite" to get more crown per pass. The Z wheel drive system makes control much easier. The back plate is boiler plate steel and rollers are high-density polymer for mar resistant contact with fine marine tubing. The center roller is fully adjustable.

The Crownarc is supplied with rollers cut for 1 inch diameter marine tubing. This easily crowns 1 inch and 7/8 inch stainless or aluminum marine tubing. Bender can be mounted on the wall, on a table or on the side or rear of a truck.

ITEM #	DESCRIPTION	FOR	RADIUS	STANDARD PACKAGE
205329	Gear Mounted Roller	1 in. square tubing	1 in.	1
205327	Tube Bender	1 in. square tubing		1
205362	Tube Bender	1-1/4 in. round tubing		1
205325	Tube Bender	7/8 in. and 1 in. tubing		1



999075

Hand Roller

ITEM #	STYLE #	MATERIAL	STANDARD PACKAGE	WIDTH
999075	11-150	Silicon	1	1.75 in.



500582

Tape – Thermo Bonding

Thermo Bonding Tape has a slightly lower melting point than the standard bonding tape. This will allow the user to seal more difficult fabrics.

ITEM #	DESCRIPTION	COLOR	PUT UP	WIDTH
500581	FR	White	100 yd., 12/box	7/8 in.
500582	FR	Black	100 yd., 12/box	7/8 in.

TRIM AND CORD

EMBROIDERY	274
EMBELLISHMENTS	276
AWNING BRAID	278
TASSELS	279
MARINE BINDING	280
THREAD AND BOBBINS	288
WEBBING	299
ROPE AND CORDAGE	310



Sunbrella® Embroidery Thread

Sunbrella embroidery thread is a revolutionary embroidery product which brings the industry-leading color fastness and weather durability of Sunbrella fabrics to decorative stitching. Sunbrella embroidery thread opens up infinite possibilities for customizing outdoor and indoor products, offers carefree cleaning, and enables the creation of beautiful, durable embroidery. Sunbrella embroidery thread can be used for decorative cushions, monogramming, boat tops, resort umbrellas, bags and accessories, awnings and tents and many other applications.

WARRANTY 5-Year

ITEM #	STYLE #	APPROX. YARDS PER POUND	AVERAGE BREAKING STRENGTH	COLOR	PUT UP	SIZE
542828	98028	2800	23 lbs.	Antique Beige	12/box	#24
542845	98045	2800	23 lbs.	Bay Brown	12/box	#24
542847	98047	2800	23 lbs.	Black	12/box	#24
542827	98027	2800	23 lbs.	Cadet Grey	12/box	#24
542826	98026	2800	23 lbs.	Captain Navy	12/box	#24
542846	98046	2800	23 lbs.	Charcoal	12/box	#24
542834	98034	2800	23 lbs.	Forest Green	12/box	#24
542841	98041	2800	23 lbs.	Gold	12/box	#24
542830	98030	2800	23 lbs.	Jockey Red	12/box	#24
542844	98044	2800	23 lbs.	Palm	12/box	#24
542842	98042	2800	23 lbs.	Peridot	12/box	#24
542829	98029	2800	23 lbs.	Pigmented White	12/box	#24
542843	98043	2800	23 lbs.	Rust	12/box	#24
542839	98039	2800	23 lbs.	Taupe	12/box	#24
542848	98048	2800	23 lbs.	Tuscan Orange	12/box	#24
542840	98040	2800	23 lbs.	Vellum	12/box	#24

Sunbrella® is a registered trademark of Glen Raven, Inc.

Sunbrella® Embroidery Bobbins

Sunbrella embroidery thread is a revolutionary embroidery product which brings the industry-leading color fastness and weather durability of Sunbrella fabrics to decorative stitching. Sunbrella embroidery thread opens up infinite possibilities for customizing outdoor and indoor products, offers carefree cleaning, and enables the creation of beautiful, durable embroidery. Sunbrella embroidery thread can be used for decorative cushions, monogramming, boat tops, resort umbrellas, bags and accessories, awnings and tents and many other applications.

WARRANTY					5-Year			
ITEM #	STYLE #	APPROX. YARDS PER BOBBIN	APPROX. YARDS PER POUND	AVERAGE BREAKING STRENGTH	COLOR	PUT UP	SIZE	STYLE
542887	98047	76	5,600	10 lbs.	Black	100/box	Tex 18	L
542890	98029	118	5,600	10 lbs.	Pigmented White	65/box	Tex 18	M
542869	98029	76	5,600	10 lbs.	Pigmented White	100/box	Tex 18	L

Sunbrella® is a registered trademark of Glen Raven, Inc.

Backing – Tear-Away

Designed for use on stable fabrics such as, satin jackets, denim, bath towels and similar items.

ITEM #	PUT UP	SIZE	WIDTH
542807	250 pack	8 in. x 8 in.	
542808	250 yds.		6 in.
542809	250 yds.		10 in.
542810	250 yds.		15 in.

Backing – Cut-Away

Designed for maximum stability, this soft cut-away backing is ideal for use on sweaters, sports style garments, or any job where backing material will come in contact with skin.

ITEM #	PUT UP	SIZE	WIDTH
542811	100 pack	8 in. x 8 in.	
542812	150 yds.		6 in.
542813	150 yds.		10 in.
542814	150 yds.		15 in.

Solvey

A water-soluble biodegradable topping that keeps stitches from sinking into terry knits and similar fabrics.

ITEM #	PUT UP	SIZE	WIDTH
542815	100 pack	8 in. x 8 in.	
542816	275 yds.		5 in.
542817	275 yds.		9 in.
542818	275 yd.		13 in.



Sunbrella® Brush Fringe

Brush fringe is constructed from Sunbrella yarns. Can be used for marine and patio throw pillows, or as a decorative umbrella trimming. Colors and blends are specifically selected to complement our Fusion Collection as well as the Sunbrella Upholstery Collection.

3 yard minimum for cut yardage.

ITEM #	STYLE #	COLOR	PUT UP	WIDTH
504507	08337-2	Barley	25 yd.	2 in.
503768	07104	Black/Charcoal/Toast	25 yd.	3 in.
504502	07300-4635	Buttercup	25 yd.	2 in.
504504	07697-2	Classic	25 yd.	2 in.
504515	08354-2	Clay	25 yd.	2 in.
503874	07300	Cocoa	25 yd.	2 in.
504510	08347-2	Dune	25 yd.	2 in.
504516	08359-2	Dusk	25 yd.	2 in.
504511	08348-2	Flame	25 yd.	2 in.
504503	07300-5462	Hot Pink	25 yd.	2 in.
504513	08351-2	Indigo	25 yd.	2 in.
503856	06867	Jockey Red	25 yd.	2 in.
503657	06917	Linen/Linen Boucle	25 yd.	2 in.
504517	08362-2	Meadow	25 yd.	2 in.
503855	06865	Natural	25 yd.	2 in.
504501	07300-4608	Onyx	25 yd.	2 in.
504514	08352-2	Opal	25 yd.	2 in.
504505	08290-2	Papaya	25 yd.	2 in.
504508	08345-2	Putty	25 yd.	2 in.
504506	08293-2	Rain Forest	25 yd.	2 in.
504512	08350-2	Redwood	25 yd.	2 in.
504500	07300-4604	Salt	25 yd.	2 in.
504509	08346-2	Smoke	25 yd.	2 in.



Sunbrella® Twist Cord-Edge

Twisted bead is constructed from Sunbrella yarns. Color-matched sewing tab. Can be used as a welting on marine and patio cushions or as a decorative umbrella trimming. Colors and blends are specifically selected to complement our Fusion Collection as well as the Sunbrella Upholstery Collection.

3 yard minimum for cut yardage.

ITEM #	STYLE #	COLOR	PUT UP	WIDTH
504706	07313-4633	Almond	25 yd.	3/8 in.
504720	07313-5416	Aruba	25 yd.	3/8 in.
504729	08337	Barley	25 yd.	3/8 in.
504707	07313-4635	Buttercup	25 yd.	3/8 in.
504714	07313-4675	Capri	25 yd.	3/8 in.
504703	07313-4621	Chocolate	25 yd.	3/8 in.
504715	07313-4676	Cocoa	25 yd.	3/8 in.
504700	07313-4603	Crimson	25 yd.	3/8 in.
504721	07313-5418	Deep Sea	25 yd.	3/8 in.
504705	07313-4630	Dove	25 yd.	3/8 in.
504732	08347-CE	Dune	25 yd.	3/8 in.
504733	08348-CE	Flame	25 yd.	3/8 in.
504717	07313-4685	Ginkgo	25 yd.	3/8 in.
504724	07313-5441	Gold	25 yd.	3/8 in.
504708	07313-4644	Graphite	25 yd.	3/8 in.
504725	07313-5462	Hot Pink	25 yd.	3/8 in.
504734	08349	Linden	25 yd.	3/8 in.
504719	07313-5415	Melon	25 yd.	3/8 in.
504728	07532-CE	Nautical	25 yd.	3/8 in.
504704	07313-4626	Navy	25 yd.	3/8 in.
504718	07313-4686	Nutmeg	25 yd.	3/8 in.
504702	07313-4608	Onyx	25 yd.	3/8 in.
504723	07313-5421	Palm	25 yd.	3/8 in.
504710	07313-4649	Plum	25 yd.	3/8 in.
504730	08345	Putty	25 yd.	3/8 in.
504701	07313-4604	Salt	25 yd.	3/8 in.
504722	07313-5420	Sky	25 yd.	3/8 in.
504731	08346	Smoke	25 yd.	3/8 in.
504712	07313-4673	Spa	25 yd.	3/8 in.
504709	07313-4648	Stone	25 yd.	3/8 in.
504726	07313-5488	Teak	25 yd.	3/8 in.
504716	07313-4677	Tuscan	25 yd.	3/8 in.
504727	07313-5498	Vellum	25 yd.	3/8 in.
504713	07313-4674	Wheat	25 yd.	3/8 in.
504711	07313-4672	Wren	25 yd.	3/8 in.

Sunbrella® is a registered trademark of Glen Raven, Inc.



Bullion Fringe – Blended Polyester

ITEM #	STYLE #	COLOR	PUT UP	WIDTH
503713	1038	Medium White	36 yd.	2-1/2 in.
503720	1035	Medium White	36 yd.	4 in.



Sunbrella® Braid – 13/16 in. – No. 4015 European Style

A 13/16 inch, 100% Sunbrella® Acrylic braid. This braid has exceptional color retention.

ITEM #	STYLE #	COLOR	PUT UP	WIDTH
503038	4015	Alpine Green	100 yd.	13/16 in.
503032	4015	Aquamarine	100 yd.	13/16 in.
503020	4015	Beige	100 yd.	13/16 in.
503037	4015	Black	100 yd.	13/16 in.
503046	4015	Blended Brown	100 yd.	13/16 in.
503009	4015	Blended Gold	100 yd.	13/16 in.
503090	4015	Brass	100 yd.	13/16 in.
503025	4015	Burgundy	100 yd.	13/16 in.
503036	4015	Buttercup	100 yd.	13/16 in.
503040	4015	Captain Navy	100 yd.	13/16 in.
503097	4015	Charcoal Grey	100 yd.	13/16 in.
503096	4015	Concord	100 yd.	13/16 in.
503027	4015	Forest Green	100 yd.	13/16 in.
503023	4015	Green	100 yd.	13/16 in.
503021	4015	Grey	100 yd.	13/16 in.
503045	4015	Ivory	100 yd.	13/16 in.
503041	4015	Linen	100 yd.	13/16 in.
503039	4015	Logo Red	100 yd.	13/16 in.
503094	4015	Mediterranean Blue	100 yd.	13/16 in.
503016	4015	Natural	100 yd.	13/16 in.
503029	4015	Navy Blue	100 yd.	13/16 in.
503022	4015	Pacific Blue	100 yd.	13/16 in.
503024	4015	Persian Green	100 yd.	13/16 in.
503034	4015	Plum	100 yd.	13/16 in.
503030	4015	Red	100 yd.	13/16 in.
503033	4015	Sapphire	100 yd.	13/16 in.
503035	4015	Sky Blue	100 yd.	13/16 in.
503092	4015	Taupe	100 yd.	13/16 in.
503028	4015	Terracotta	100 yd.	13/16 in.
503091	4015	Toast	100 yd.	13/16 in.
503019	4015	True Brown	100 yd.	13/16 in.
503093	4015	Turquoise	100 yd.	13/16 in.
503026	4015	Vanilla	100 yd.	13/16 in.
503042	4015	Yellow	100 yd.	13/16 in.

Sunbrella® is a registered trademark of Glen Raven, Inc.

Sunbrella® Braid – 13/16 in. – No. 681

A 13/16 inch 100% Sunbrella® Acrylic braid and is manufactured using four ends of Sunbrella yarn in one strand. This braid has exceptional color retention.

ITEM #	STYLE #	COLOR	COLOR #	PUT UP	WIDTH
503082	681	Alpine	ABA55	100 yd.	13/16 in.
503055	681	Aquamarine	ABA23	100 yd.	13/16 in.
502976	681	Aruba	ABA5416	100 yd.	13/16 in.
502955	681	Aspen	ABA68	100 yd.	13/16 in.
503052	681	Beige	ABA20	100 yd.	13/16 in.
503044	681	Black	ABA08	100 yd.	13/16 in.
502941	681	Black Cherry	ABA40	100 yd.	13/16 in.
502948	681	Blended Brown	ABA13	100 yd.	13/16 in.
502946	681	Brass	ABA58	100 yd.	13/16 in.
503060	681	Burgundy	ABA31	100 yd.	13/16 in.
503074	681	Buttercup	ABA35	100 yd.	13/16 in.
503059	681	Cadet Grey	ABA30	100 yd.	13/16 in.
502958	681	Capri	ABA75	100 yd.	13/16 in.
503079	681	Captain Navy	ABA46	100 yd.	13/16 in.
502942	681	Charcoal	ABA44	100 yd.	13/16 in.
502970	681	Charcoal Tweed	ABA07	100 yd.	13/16 in.
502959	681	Cocoa	ABA76	100 yd.	13/16 in.
502953	681	Concord	ABA65	100 yd.	13/16 in.
503076	681	Coral	ABA38	100 yd.	13/16 in.
502969	681	Dubonnet Tweed	ABA06	100 yd.	13/16 in.
503048	681	Erin Green	ABA00	100 yd.	13/16 in.
503085	681	Fern	ABA71	100 yd.	13/16 in.
503075	681	Forest Green	ABA37	100 yd.	13/16 in.
502980	681	Ginkgo	ABA4685	100 yd.	13/16 in.
503089	681	Granite	ABA82	100 yd.	13/16 in.
503086	681	Heather Beige	ABA72	100 yd.	13/16 in.
502966	681	Hemlock Tweed	ABA05	100 yd.	13/16 in.
503084	681	Ivory	ABA9506	100 yd.	13/16 in.
502982	681	Ivy	ABA4632	100 yd.	13/16 in.
503051	681	Jockey Red	ABA03	100 yd.	13/16 in.
503073	681	Linen	ABA33	100 yd.	13/16 in.
502967	681	Linen Tweed	ABA54	100 yd.	13/16 in.
503083	681	Logo Red	ABA66	100 yd.	13/16 in.
502954	681	Mahogany	ABA67	100 yd.	13/16 in.
502961	681	Marine Blue	ABA78	100 yd.	13/16 in.
502952	681	Mauve	ABA39	100 yd.	13/16 in.
503081	681	Mediterranean Blue	ABA52	100 yd.	13/16 in.
502963	681	Mediterranean Blue Tweed	ABA53	100 yd.	13/16 in.
502968	681	Mocha	ABA16	100 yd.	13/16 in.
503043	681	Natural	ABA04	100 yd.	13/16 in.
503057	681	Navy Blue	ABA26	100 yd.	13/16 in.
502973	681	Nutmeg	ABA4686	100 yd.	13/16 in.
502962	681	Ocean Blue	ABA79	100 yd.	13/16 in.
503087	681	Orange	ABA09	100 yd.	13/16 in.
502972	681	Oyster	ABA42	100 yd.	13/16 in.
503049	681	Pacific Blue	ABA01	100 yd.	13/16 in.

ITEM #	STYLE #	COLOR	COLOR #	PUT UP	WIDTH
502979	681	Palm	ABA5421	100 yd.	13/16 in.
503088	681	Parchment	ABA83	100 yd.	13/16 in.
503078	681	Persian Green	ABA43	100 yd.	13/16 in.
502965	681	Persian Tweed	ABA47	100 yd.	13/16 in.
503080	681	Plum	ABA49	100 yd.	13/16 in.
502964	681	Royal Blue	ABA17	100 yd.	13/16 in.
502974	681	Rust	ABA4689	100 yd.	13/16 in.
503047	681	Salmon	ABA27	100 yd.	13/16 in.
503077	681	Sapphire	ABA41	100 yd.	13/16 in.
502943	681	Sea Grass	ABA45	100 yd.	13/16 in.
502947	681	Sea Spray	ABA11	100 yd.	13/16 in.
502971	681	Silver	ABA51	100 yd.	13/16 in.
503056	681	Sky Blue	ABA24	100 yd.	13/16 in.
502981	681	Slate	ABA4684	100 yd.	13/16 in.
502956	681	Spa	ABA73	100 yd.	13/16 in.
503050	681	Sunflower Yellow	ABA02	100 yd.	13/16 in.
502949	681	Tan	ABA14	100 yd.	13/16 in.
502944	681	Taupe	ABA48	100 yd.	13/16 in.
503054	681	Terracotta	ABA22	100 yd.	13/16 in.
502951	681	Toast	ABA28	100 yd.	13/16 in.
503053	681	True Brown	ABA21	100 yd.	13/16 in.
502960	681	Tuscan	ABA77	100 yd.	13/16 in.
503058	681	Vanilla	ABA29	100 yd.	13/16 in.
502950	681	Walnut Brown Tweed	ABA18	100 yd.	13/16 in.
502957	681	Wheat	ABA74	100 yd.	13/16 in.

Sunbrella® is a registered trademark of Glen Raven, Inc.



Sunbrella® Braid – 5/8 in. – No. 6118

5/8 inch wide braid made from 100% Sunbrella® Acrylic.

ITEM #	STYLE #	COLOR	PUT UP	WIDTH
503155	6118	Alpine	1 gr. yd.	5/8 in.
503223	6118	Beige	1 gr. yd.	5/8 in.
503221	6118	Black	1 gr. yd.	5/8 in.
503225	6118	Blended Brown	1 gr. yd.	5/8 in.
503129	6118	Blue	1 gr. yd.	5/8 in.
503132	6118	Brown	1 gr. yd.	5/8 in.
503228	6118	Burgundy	1 gr. yd.	5/8 in.
503154	6118	Buttercup	1 gr. yd.	5/8 in.
503158	6118	Captain Navy	1 gr. yd.	5/8 in.
503159	6118	Charcoal Grey	1 gr. yd.	5/8 in.
503138	6118	Forest Green	1 gr. yd.	5/8 in.
503137	6118	Green	1 gr. yd.	5/8 in.
503134	6118	Grey	1 gr. yd.	5/8 in.
503150	6118	Ivory	1 gr. yd.	5/8 in.
503130	6118	Linen	1 gr. yd.	5/8 in.
503156	6118	Logo Red	1 gr. yd.	5/8 in.
503128	6118	Mediterranean Blue	1 gr. yd.	5/8 in.
503153	6118	Natural	1 gr. yd.	5/8 in.
503142	6118	Navy	1 gr. yd.	5/8 in.
503144	6118	Plum	1 gr. yd.	5/8 in.
503141	6118	Red	1 gr. yd.	5/8 in.
503157	6118	Taupe	1 gr. yd.	5/8 in.
503147	6118	Terracotta	1 gr. yd.	5/8 in.
503148	6118	Toast	1 gr. yd.	5/8 in.
503152	6118	Turquoise	1 gr. yd.	5/8 in.
503149	6118	Vanilla	1 gr. yd.	5/8 in.
503136	6118	Yellow	1 gr. yd.	5/8 in.

Sunbrella® is a registered trademark of Glen Raven, Inc.



Tassels – Polyester

Polyester tassels are handmade and can be used indoors and out. They are mildew-proof and resist dust and dirt. Sizes shown are overall sizes of tassel, not including loop.

ITEM #	STYLE #	COLOR	SIZE
503444	1036	White	4 in.
503445	1036	Black	4 in.



Tassels – Synthetic Wood

ITEM #	SIZE
503469	4 in.



Braid – Polyester

Ideal for use with all awning fabrics. Also used to bind boat tops. Resists deteriorating effects of sunlight and weather. Excellent sewability. Recommend sewing with polyester thread.

ITEM #	STYLE #	COLOR	PUT UP	WIDTH
503306	61-20	Black	1 gr. yd.	5/8 in.
503311	61-20	Blue	1 gr. yd.	5/8 in.
503307	61-20	Brown	1 gr. yd.	5/8 in.
503303	61-20	Ecru	1 gr. yd.	5/8 in.
503302	5314	White	2 gr. yd.	5/8 in.



Tape – No. 281 Nylon

A quality nylon tape for binding nylons and most other fabrics. Makes a neat, attractive finish.

ITEM #	STYLE #	COLOR	PUT UP	WIDTH
502021	281/30119	Black	100 yd.	1 in.
502025	281/N0088	Black	100 yd.	1 in.
502008	281/30119	Black	100 yd.	3/4 in.
502024	281/N0088	Black	100 yd.	3/4 in.
502009	281/N0088	Navy	100 yd.	3/4 in.
502019	281/N0088	White	100 yd.	1 in.
502007	281/N0088	White	100 yd.	3/4 in.



Sunbrella® Marine Binding – Centerfold

100% Sunbrella Acrylic. Natural fold in center. Will not fade or weaken from normal exposure conditions, including sunlight, mildew, rot and atmospheric chemicals. Binding will not “neckdown” under tension. Blind side behaves same as front.

ITEM #	STYLE #	COLOR	COLOR #	PUT UP	WIDTH
503920	70-1968	Beige	20	200 yd.	7/8 in.
503915	70-1968	Black	08	200 yd.	7/8 in.
503916	70-1968	Burgundy	31	200 yd.	7/8 in.
503912	70-1968	Cadet Grey	30	200 yd.	7/8 in.
504447	70-1968	Captain Navy	6646	200 yd.	7/8 in.
504442	70-1968	Concord	6665	200 yd.	7/8 in.
503919	70-1968	Forest Green	37	200 yd.	7/8 in.
504439	70-1968	Linen	33	200 yd.	7/8 in.
504344	70-1968	Mediterranean Blue	6652	200 yd.	7/8 in.
503914	70-1968	Natural	04	200 yd.	7/8 in.
503913	70-1968	Navy	26	200 yd.	7/8 in.
504446	70-1968	Oyster	6642	200 yd.	7/8 in.
503911	70-1968	Pacific Blue	01	200 yd.	7/8 in.
504440	70-1968	Red	6603	200 yd.	7/8 in.
504449	70-1968	Taupe	48	200 yd.	7/8 in.
504443	70-1968	True Brown	21	200 yd.	7/8 in.
503917	70-1968	Turquoise	10	200 yd.	7/8 in.

Sunbrella® is a registered trademark of Glen Raven, Inc.

Sunbrella® Marine Binding – Centerfold – Type 1810

ITEM #	STYLE #	COLOR	COLOR #	PUT UP	WIDTH
504460	1810	Black	08	200 yd.	7/8 in.
504456	1810	Cadet Grey	30	200 yd.	7/8 in.

Sunbrella® is a registered trademark of Glen Raven, Inc.



Sunbrella® Marine Binding – Double-Fold Bias Cut

Sunbrella Acrylic marine binding in matching colors. Provides excellent color retention and weatherability. A double folded edge gives a finished and attractive look. Double folded and glued back 1/4 inch on each side. Bias cut binding assures pucker-free seams around curves and radius.

ITEM #	STYLE #	COLOR	PUT UP	WIDTH
504239	4620	Beige	100 yd.	1 in.
503932	4620	Beige	100 yd.	3/4 in.
504208	4608	Black	100 yd.	1 in.
504330	4608	Black	100 yd.	1-1/4 in.
503928	4608	Black	100 yd.	3/4 in.
504258	4658	Brass	100 yd.	1 in.
503963	4658	Brass	100 yd.	3/4 in.
504231	4631	Burgundy	100 yd.	1 in.
503929	4631	Burgundy	100 yd.	3/4 in.
504230	4630	Cadet Grey	100 yd.	1 in.
504334	4630	Cadet Grey	100 yd.	1-1/4 in.
503950	4630	Cadet Grey	100 yd.	3/4 in.
503968	4675	Capri	100 yd.	3/4 in.
504211	4646	Captain Navy	100 yd.	1 in.
504351	4646	Captain Navy	100 yd.	1-1/4 in.
503946	4646	Captain Navy	100 yd.	3/4 in.
504235	4644	Charcoal Grey	100 yd.	1 in.
504236	4607	Charcoal Tweed	100 yd.	1 in.
504317	4676	Cocoa	100 yd.	1 in.
503969	4676	Cocoa	100 yd.	3/4 in.
504229	4606	Dubonnet Tweed	100 yd.	1 in.
503934	4606	Dubonnet Tweed	100 yd.	3/4 in.
504315	4671	Fern	100 yd.	1 in.
503964	4671	Fern	100 yd.	3/4 in.
504237	4637	Forest Green	100 yd.	1 in.
504328	4637	Forest Green	100 yd.	1-1/4 in.
503945	4637	Forest Green	100 yd.	3/4 in.
504272	4672	Heather Beige	100 yd.	1 in.
503965	4672	Heather Beige	100 yd.	3/4 in.
504207	4605	Hemlock Tweed	100 yd.	1 in.
503957	4605	Hemlock Tweed	100 yd.	3/4 in.
504254	4654	Linen Tweed	100 yd.	1 in.
504327	4654	Linen Tweed	100 yd.	1-1/4 in.
503954	4654	Linen Tweed	100 yd.	3/4 in.
504233	4633	Linen	100 yd.	1 in.
504348	4633	Linen	100 yd.	1-1/4 in.
503958	4633	Linen	100 yd.	3/4 in.
504218	4666	Logo Red	100 yd.	1 in.
504318	4678	Marine Blue	100 yd.	1 in.
503970	4678	Marine Blue	100 yd.	3/4 in.
504314	4653	Mediterranean Blue Tweed	100 yd.	1 in.
503941	4653	Mediterranean Blue Tweed	100 yd.	3/4 in.

ITEM #	STYLE #	COLOR	PUT UP	WIDTH
504213	4652	Mediterranean Blue	100 yd.	1 in.
504320	4652	Mediterranean Blue	100 yd.	1-1/4 in.
504204	4604	Natural	100 yd.	1 in.
504331	4604	Natural	100 yd.	1-1/4 in.
503924	4604	Natural	100 yd.	3/4 in.
504226	4626	Navy	100 yd.	1 in.
504326	4626	Navy	100 yd.	1-1/4 in.
503922	4626	Navy	100 yd.	3/4 in.
504200	4679	Ocean Blue	100 yd.	1 in.
503971	4679	Ocean Blue	100 yd.	3/4 in.
504209	4642	Oyster	100 yd.	1 in.
504349	4642	Oyster	100 yd.	1-1/4 in.
503942	4642	Oyster	100 yd.	3/4 in.
504201	4601	Pacific Blue	100 yd.	1 in.
504346	4601	Pacific Blue	100 yd.	1-1/4 in.
503921	4601	Pacific Blue	100 yd.	3/4 in.
504243	4643	Persian Green	100 yd.	1 in.
504350	4643	Persian Green	100 yd.	1-1/4 in.
503940	4643	Persian Green	100 yd.	3/4 in.
504203	4603	Red	100 yd.	1 in.
503925	4603	Red	100 yd.	3/4 in.
504217	4617	Royal Blue Tweed	100 yd.	1 in.
503923	4617	Royal Blue Tweed	100 yd.	3/4 in.
504347	4617	Royal Blue	100 yd.	1-1/4 in.
503933	4641	Sapphire Blue	100 yd.	3/4 in.
504205	4641	Sapphire Blue	100 yd.	1 in.
503975	4859	Silica Dune	100 yd.	3/4 in.
504232	4651	Silver	100 yd.	1 in.
503962	4651	Silver	100 yd.	3/4 in.
504289	4673	Spa	100 yd.	1 in.
503966	4673	Spa	100 yd.	3/4 in.
504216	4602	Sunflower Yellow	100 yd.	1 in.
504227	4648	Taupe	100 yd.	1 in.
503959	4648	Taupe	100 yd.	3/4 in.
504319	2389	Toast Tweed	100 yd.	1 in.
504325	4689	Toast Tweed	100 yd.	1-1/4 in.
503956	2389	Toast Tweed	100 yd.	3/4 in.
504225	4628	Toast	100 yd.	1 in.
503952	4628	Toast	100 yd.	3/4 in.
504234	4621	True Brown	100 yd.	1 in.
503927	4621	True Brown	100 yd.	3/4 in.
504316	4674	Wheat	100 yd.	1 in.
503967	4674	Wheat	100 yd.	3/4 in.

Sunbrella® is a registered trademark of Glen Raven, Inc.



Sunbrella® Marine Binding – Double-Fold Straight Cut

Sunbrella Acrylic marine binding in matching colors. Provides excellent color retention and weatherability. A double folded edge gives a finished and attractive look. Double folded and glued back 1/4 inch on each side.

ITEM #	STYLE #	COLOR	PUT UP	WIDTH
502036	4623	Aquamarine	100 yd.	1 in.
504043	4623	Aquamarine	100 yd.	3/4 in.
504077	4668	Aspen	100 yd.	3/4 in.
504020	4620	Beige	100 yd.	3/4 in.
502034	4608	Black	100 yd.	1 in.
504028	4608	Black	100 yd.	3/4 in.
504119	4608	Black	200 yd.	3/4 in.
504088	4608	Black	300 yd.	7/8 in.
502040	4631	Burgundy	100 yd.	1 in.
504051	4631	Burgundy	100 yd.	3/4 in.
504015	4635	Buttercup	100 yd.	3/4 in.
504050	4630	Cadet Grey	100 yd.	3/4 in.
502044	4646	Captain Navy	100 yd.	1 in.
504047	4646	Captain Navy	100 yd.	3/4 in.
504027	4607	Charcoal Tweed	100 yd.	3/4 in.
504049	4644	Charcoal	100 yd.	3/4 in.
504065	4665	Concord	100 yd.	3/4 in.
502033	4606	Dubonnet Tweed	100 yd.	1 in.
504026	4606	Dubonnet Tweed	100 yd.	3/4 in.
504057	4637	Forest Green	100 yd.	3/4 in.
504071	4672	Heather Beige	100 yd.	3/4 in.
502032	4605	Hemlock Tweed	100 yd.	1 in.
504025	4605	Hemlock Tweed	100 yd.	3/4 in.
504080	4632	Ivy	100 yd.	3/4 in.
504054	4654	Linen Tweed	100 yd.	3/4 in.
504033	4633	Linen	100 yd.	3/4 in.
504035	4666	Logo Red	100 yd.	3/4 in.
504078	4678	Marine Blue	100 yd.	3/4 in.
502046	4653	Mediterranean Blue Tweed	100 yd.	1 in.
504053	4653	Mediterranean Blue Tweed	100 yd.	3/4 in.
502045	4652	Mediterranean Blue	100 yd.	1 in.
504052	4652	Mediterranean Blue	100 yd.	3/4 in.
504016	4616	Mocha Tweed	100 yd.	3/4 in.
504024	4604	Natural	100 yd.	3/4 in.
504046	4626	Navy	100 yd.	3/4 in.
503999	4686	Nutmeg	100 yd.	3/4 in.
504079	4679	Ocean Blue	100 yd.	3/4 in.
504036	4642	Oyster	100 yd.	3/4 in.
504090	4642	Oyster	300 yd.	7/8 in.
504021	4601	Pacific Blue	100 yd.	3/4 in.

ITEM #	STYLE #	COLOR	PUT UP	WIDTH
502043	4643	Persian Green	100 yd.	1 in.
504029	4643	Persian Green	100 yd.	3/4 in.
504023	4603	Jockey Red	100 yd.	3/4 in.
504300	4617	Royal Blue	100 yd.	1 in.
504034	2079	Royal Navy	100 yd.	3/4 in.
504037	4617	Royal	100 yd.	3/4 in.
504022	4641	Sapphire	100 yd.	3/4 in.
504031	4651	Silver	100 yd.	3/4 in.
504055	4624	Sky Blue	100 yd.	3/4 in.
504060	4602	Sunflower Yellow	100 yd.	3/4 in.
504014	4614	Tan	100 yd.	3/4 in.
504042	4648	Taupe	100 yd.	3/4 in.
504032	4650	Teal Tweed	100 yd.	3/4 in.
504059	2389	Toast Tweed	100 yd.	3/4 in.
504048	4628	Toast	100 yd.	3/4 in.
504041	4621	True Brown	100 yd.	3/4 in.
504030	4610	Turquoise	100 yd.	3/4 in.

Sunbrella® is a registered trademark of Glen Raven, Inc.

Aqualon® Edge Binding

Double-folded, straight cut. Colors match Aqualon Edge marine top and cover fabric.

ITEM #	STYLE #	COLOR	PUT UP	WIDTH
502757	17	Alpine White	100 yd.	3/4 in.
502753	07	Apple Red	100 yd.	3/4 in.
502762	44	Atlantic Blue	100 yd.	3/4 in.
502764	68	Basic Beige	100 yd.	3/4 in.
502750	00	Black Onyx	100 yd.	3/4 in.
502755	09	Cabernet	100 yd.	3/4 in.
502758	18	Charcoal Grey	100 yd.	3/4 in.
502767	13	Cherry Red	100 yd.	3/4 in.
502768	42	Classic Silver	100 yd.	3/4 in.
502754	08	Coastal Ivory	100 yd.	3/4 in.
502765	69	Indigo Blue	100 yd.	3/4 in.
502751	03	Ivy Green	100 yd.	3/4 in.
502759	21	Mountain Taupe	100 yd.	3/4 in.
502760	28	Nautical Navy	100 yd.	3/4 in.
502770	42	Oxford Tan	100 yd.	3/4 in.
502766	71	Slate Grey	100 yd.	3/4 in.
502763	49	Toast	100 yd.	3/4 in.
502756	12	True Blue	100 yd.	3/4 in.
502752	04	True Teal	100 yd.	3/4 in.

Aqualon® is a registered trademark of Glen Raven, Inc.



Riviera Marine Fabric™ Binding

Binding is an exact match to Herculite® Riviera Marine Fabric, which creates a uniform marine fabrication. Made from a 100% PVC composite supported by high strength woven polyester, this high-quality fabric features the Rain Kleen® II finish, making it well suited for a variety of marine environments. This bias cut binding assures pucker free seams around curves and radius.

ITEM #	DESCRIPTION	COLOR	PUT UP	WIDTH
502352	Double-Fold	Ivory	50 yd.	3/4 in.
502355	Double-Fold	Snow White	50 yd.	1 in.
502350	Double-Fold	Snow White	50 yd.	3/4 in.
502356	Double-Fold	White	50 yd.	1 in.
502351	Double-Fold	White	50 yd.	3/4 in.
502360	Single-Fold	Snow White	50 yd.	1-1/4 in.
502361	Single-Fold	White	50 yd.	1-1/4 in.

Herculite® and Rain-Kleen® are registered trademarks of Herculite Products Inc. Herculite Riviera Marine Fabric™ is a trademark of Herculite Products Inc.



Regatta® Binding

This vinyl laminated polyester bias cut binding is made from waterproof and mildew-resistant Regatta Marine Fabric.

ITEM #	STYLE #	DESCRIPTION	COLOR	PUT UP	WIDTH
502265	45	Double-Fold	Black	50 yd.	1 in.
502245	45	Double-Fold	Black	50 yd.	3/4 in.
502259	39	Double-Fold	Ivory	50 yd.	1 in.
502239	39	Double-Fold	Ivory	50 yd.	3/4 in.
502247	17	Double-Fold	White	50 yd.	1 in.
502230	17	Double-Fold	White	50 yd.	3/4 in.
502267	17	Single-Fold	White	50 yd.	1-1/4 in.

Regatta® is a registered trademark of Herculite Products Inc.



Stamoid® Binding

Made from light weight, strong and flexible Stamoid. Bias cut.

ITEM #	STYLE #	COLOR	PUT UP	WIDTH
502893	2ET	Black	100 yd.	1 in.
502921	1ET	Black	100 yd.	1-1/4 in.
502871	2ET	Black	100 yd.	3/4 in.
502895	2ET	Cream	100 yd.	1 in.
502911	1ET	Cream	100 yd.	1-1/4 in.
502861	2ET	Cream	100 yd.	3/4 in.
502892	2ET	Ivory	100 yd.	1 in.
502912	1ET	Ivory	100 yd.	1-1/4 in.
502862	2ET	Ivory	100 yd.	3/4 in.
502894	2ET	Navy	100 yd.	1 in.
502872	2ET	Navy	100 yd.	3/4 in.
502864	2ET	Pearl Gray	100 yd.	3/4 in.
502868	2ET	Royal Blue	100 yd.	3/4 in.
502863	2ET	Sand	100 yd.	3/4 in.
502865	2ET	Silver	100 yd.	3/4 in.
502891	2ET	Snow White	100 yd.	1 in.
502914	1ET	Snow White	100 yd.	1-1/4 in.
502873	2ET	Snow White	100 yd.	3/4 in.
502890	2ET	White	100 yd.	1 in.
502910	1ET	White	100 yd.	1-1/4 in.
502860	2ET	White	100 yd.	3/4 in.

Stamoid® is a registered trademark of The Serge Ferrari Group.



Binding – Vinyl – Imperial

An embossed coated vinyl on a drill backing. Bias cut. The vinyl and drill contain mildew inhibitors for added life.

Styles 560, 569 and 573 are raw edge (RE).

ITEM #	STYLE #	COLOR	PUT UP	WIDTH
515606	560 RE	Beige	135 yd.	1-1/4 in.
504825	552	Black	100 yd.	1-1/4 in.
515590	949	Black	100 yd.	1-1/4 in.
504633	552	Black	100 yd.	3/4 in.
515595	949	Black	100 yd.	3/4 in.
515593	553	Blue	100 yd.	1-1/4 in.
504823	549	Bone White	100 yd.	1-1/4 in.
504826	562	Buckskin	100 yd.	1-1/4 in.
515581	576	Burgundy	100 yd.	1-1/4 in.
515592	950	Oyster	100 yd.	1-1/4 in.
515597	950	Oyster	100 yd.	3/4 in.
504822	568	Slate Gray	100 yd.	1-1/4 in.
504809	568	Slate Gray	100 yd.	3/4 in.
504495	9753	White	100 yd.	1-1/4 in.
515591	948	White	100 yd.	1-1/4 in.
504492	551	White	100 yd.	1-1/4 in.
504632	551	White	100 yd.	3/4 in.
515596	948	White	100 yd.	3/4 in.



Sur Last® Binding

Sur Last double-fold bias cut binding is made from lightweight, yet strong and flexible Sur Last 100%, solution-dyed polyester fabric. Sur Last binding provides a finished and attractive appearance.

ITEM #	COLOR	PUT UP	WIDTH
503982	Black	100 yd.	3/4 in.

Sur Last® is a registered trademark of Glen Raven, Inc.



Sunbrella® Facing

Cut from genuine Sunbrella. Wider than traditional folded binding. Can be used as a zipper facing or cover and hem application.

ITEM #	STYLE #	COLOR	PUT UP	WIDTH
502308	4608	Black	60 yd.	1-1/2 in.
502408	4608	Black	60 yd.	2 in.
502449	4608	Black	60 yd.	2-1/2 in.
502431	4631	Burgundy	60 yd.	2 in.
502330	4630	Cadet Grey	60 yd.	1-1/2 in.
502430	4630	Cadet Grey	60 yd.	2 in.
502346	4646	Captain Navy	60 yd.	1-1/2 in.
502446	4646	Captain Navy	60 yd.	2 in.
502412	4606	Dubonnet Tweed	60 yd.	2 in.
502337	4637	Forest Green	60 yd.	1-1/2 in.
502437	4637	Forest Green	60 yd.	2 in.
502411	4605	Hemlock Tweed	60 yd.	2 in.
502416	4654	Linen Tweed	60 yd.	2 in.
502290	4633	Linen	60 yd.	1-1/2 in.
502414	4633	Linen	60 yd.	2 in.
502415	4652	Mediterranean Blue	60 yd.	2 in.
502304	4604	Natural	60 yd.	1-1/2 in.
502404	4604	Natural	60 yd.	2 in.
502326	4626	Navy	60 yd.	1-1/2 in.
502426	4626	Navy	60 yd.	2 in.
502301	4601	Pacific Blue	60 yd.	1-1/2 in.
502401	4601	Pacific Blue	60 yd.	2 in.
502443	4643	Persian Green	60 yd.	2 in.
502289	4628	Toast	60 yd.	1-1/2 in.
502413	4628	Toast	60 yd.	2 in.

Sunbrella® is registered trademark of Glen Raven, Inc.



Binding – Vinyl – 300 Series

An extremely durable, seamed bias binding. An embossed vinyl on strong, high quality 14 to 15 ounce backing. Bias cut. Resists dirt, ultraviolet rays, and fraying.

ITEM #	STYLE #	COLOR	PUT UP	WIDTH
515584	308	Black	100 yd.	1-1/4 in.
515580	308	Black	100 yd.	3/4 in.
504830	354	Jade	100 yd.	3/4 in.
515576	312	Light Gray	100 yd.	1-1/4 in.
515577	312	Light Gray	100 yd.	3/4 in.
504831	325	Navy	100 yd.	3/4 in.
515587	310	Oyster	100 yd.	1-1/4 in.
515583	310	Oyster	100 yd.	3/4 in.
515585	302	Royal	100 yd.	1-1/4 in.
515578	302	Royal	100 yd.	3/4 in.
515601	309	White	100 yd.	1 in.
515586	309	White	100 yd.	1-1/4 in.
515582	309	White	100 yd.	3/4 in.



Regatta® Facing

Vinyl facing made from Regatta marine vinyl fabric.

ITEM #	STYLE #	COLOR	PUT UP	WIDTH
502201	39	Ivory	50 yd.	1-1/2 in.
502211	39	Ivory	50 yd.	2 in.
502202	17	White	50 yd.	1-1/2 in.
502210	17	White	50 yd.	2 in.

Regatta® is a registered trademark of Herculite Products Inc.



Stamoid® Facing

Vinyl facing made from Stamoid marine vinyl fabric.

ITEM #	COLOR	PUT UP	WIDTH
502850	Black	50 yd.	1-1/2 in.
502856	Black	50 yd.	2 in.
502849	Cream	50 yd.	1-1/2 in.
502855	Cream	50 yd.	2 in.
502846	Ivory	50 yd.	1-1/2 in.
502852	Ivory	50 yd.	2 in.
502843	Navy	50 yd.	1-1/2 in.
502847	Snow White	50 yd.	1-1/2 in.
502851	Snow White	50 yd.	2 in.
502848	White	50 yd.	1-1/2 in.
502854	White	50 yd.	2 in.

Stamoid® is a registered trademark of The Serge Ferrari Group.



Welting – Welt Cord

Foam welt cord is used in all upholstery applications. Simply sew vinyl, leather, or fabric around the welt cord leaving a flange to be sewn into the seams of the upholstery. Excellent for use in automotive, furniture, and marine applications.

Made of polyethylene foam, this quality and durable welt cord is used for cushion and seating upholstery. Popular in the fine furniture industry and durable enough for use in the marine and automotive industries. Also available in regular (no fill) and with polyester filler, and flame retardant with copper wire which conforms to UFAC specifications, on special order.

ITEM #	STYLE #	DESCRIPTION	COLOR	PUT UP	WIDTH
505407	773		Off White	50 yd.	5/32 in.
505406	771		White	50 yd.	5/32 in.
515538		Braided Paper		500 yd.	8/32 in.
515547		Foam (No Filler)	White	1250 yd., 6/box	4/32 in.
515526		Foam		1000 yd.	4/32 in.
515530		Foam		1000 yd.	5/32 in.

Welt

ITEM #	STYLE #	DESCRIPTION	PUT UP	SIZE
578100	PEH432500-6	Hollow PE	1500 ft.	4/32 in.

Nassimi Breeze Seaquest Hydem Gimp

Hydem gimp is used to hide staples in upholstery applications. Colors correspond with the Nassimi Breeze Seaquest Vinyl Upholstery collection.

ITEM #	COLOR	PUT UP	WIDTH
515831	American Beauty	25 yd.	5/8 in.
515832	Anchor	25 yd.	5/8 in.
515833	Buff	25 yd.	5/8 in.
515834	Chalk	25 yd.	5/8 in.
515835	Cove	25 yd.	5/8 in.
515836	Dune	25 yd.	5/8 in.
515837	Ebony	25 yd.	5/8 in.
515838	Emerald	25 yd.	5/8 in.
515839	Forest	25 yd.	5/8 in.
515840	Hampton	25 yd.	5/8 in.
515841	Havasu	25 yd.	5/8 in.
515842	Lemon Peel	25 yd.	5/8 in.
515843	Lighthouse Red	25 yd.	5/8 in.
515844	Lotion	25 yd.	5/8 in.
515845	Marble	25 yd.	5/8 in.
515846	Midnight	25 yd.	5/8 in.
515847	Mist	25 yd.	5/8 in.
515848	Navel	25 yd.	5/8 in.
515849	Navy	25 yd.	5/8 in.
515850	Oyster	25 yd.	5/8 in.
515851	Pearl Oyster	25 yd.	5/8 in.
515852	Pelican	25 yd.	5/8 in.
515853	Royal	25 yd.	5/8 in.
515854	Ruby	25 yd.	5/8 in.
515855	Sea White	25 yd.	5/8 in.
515856	Smoke	25 yd.	5/8 in.
515857	Teal	25 yd.	5/8 in.
515859	Too White	25 yd.	5/8 in.
515860	White Ice	25 yd.	5/8 in.



Nautolex® Capitano™ Hydem Gimp

ITEM #	STYLE #	COLOR	PUT UP	WIDTH
515825	449192	Beach White	25 yd.	3/4 in.
515822	448000	Cloud White	25 yd.	3/4 in.
515820	448001	Conch Shell	25 yd.	3/4 in.
515828	448007	Cyberspace	25 yd.	3/4 in.
515830	448008	Sandshell	25 yd.	3/4 in.

Nautolex® is a registered trademark of OMNOVA Solutions, Inc. Capitano™ is a trademark of OMNOVA Solutions, Inc.

Hydem Gimp – Acrylic

A very durable, acrylic split hydem gimp. Resists dirt, ultraviolet rays, mildew and fraying. Hydem gimp is used to hide staples in upholstery applications.

ITEM #	STYLE #	COLOR	PUT UP	WIDTH
515629	4631	Burgundy	100 yd.	5/8 in.
515623	4637	Forest Green	100 yd.	5/8 in.
515637	4617	Royal Blue	50 yd.	5/8 in.



Hydem Gimp

A very durable split hydem gimp. Resists dirt, ultraviolet rays, mildew and fraying. Hydem gimp is used to hide staples in upholstery applications.

ITEM #	STYLE #	COLOR	PUT UP	WIDTH
515617	308	Black	50 yd.	5/8 in.
515733	771	Mystic White	50 yd.	5/8 in.
515734	773	Off White	50 yd.	5/8 in.
515600		White	50 yd.	5/8 in.

Nassimi Breeze Seaquest Welt

Welt is used to visually enhance a seam on seating. Colors correspond with the Nassimi Breeze Seaquest Vinyl Upholstery collection.

ITEM #	COLOR	PUT UP	WIDTH
515861	American Beauty	50 yd.	5/8 in.
515862	Anchor	50 yd.	5/8 in.
515863	Buff	50 yd.	5/8 in.
515864	Chalk	50 yd.	5/8 in.
515865	Cove	50 yd.	5/8 in.
515866	Dune	50 yd.	5/8 in.
515867	Ebony	50 yd.	5/8 in.
515868	Emerald	50 yd.	5/8 in.
515869	Forest	50 yd.	5/8 in.
515870	Hampton	50 yd.	5/8 in.
515871	Havasu	50 yd.	5/8 in.
515872	Lemon Peel	50 yd.	5/8 in.
515873	Lighthouse Red	50 yd.	5/8 in.
515874	Lotion	50 yd.	5/8 in.
515875	Marble	50 yd.	5/8 in.
515876	Midnight	50 yd.	5/8 in.
515877	Mist	50 yd.	5/8 in.
515878	Navel	50 yd.	5/8 in.
515879	Navy	50 yd.	5/8 in.
515880	Oyster	50 yd.	5/8 in.
515881	Pearl Oyster	50 yd.	5/8 in.
515882	Pelican	50 yd.	5/8 in.
515883	Royal	50 yd.	5/8 in.
515884	Ruby	50 yd.	5/8 in.
515885	Sea White	50 yd.	5/8 in.
515886	Smoke	50 yd.	5/8 in.
515887	Teal	50 yd.	5/8 in.
515889	Too White	50 yd.	5/8 in.
515890	White Ice	50 yd.	5/8 in.



Welt – Rubber Spray

Made from EPDM, a dense non-marking rubber, this spray welt stays soft and easy to mold to a windshield or any other surface. With no foam to disintegrate, it lasts much longer than other weltings. It is also stronger, less likely to rip out, making it trouble free.

ITEM #	COLOR	PUT UP	SIZE
578094	Black	100 ft.	3/8 in. x 3/4 in.



Welt – Windshield

Made of vinyl-encased foam and used as a gasket between the boat top and the windshield to prevent water from entering. Style Nos. 3105-6 and 3705-6 are made of 6 mil vinyl, and Style No. 3707-10 is made of 10 mil vinyl. Style 3707-EP is EPDM Material - Synthetic Rubber.

ITEM #	STYLE #	COLOR	PUT UP	SIZE
578026	3707-10	Black	500 ft.	3/8 in. x 1-1/8 in.
578046	3707-10	Black	150 ft.	3/8 in. x 1-1/8 in. x 1/2 in. Flap
578055	3707-EP	Black	300 ft.	3/8 in. x 3/4 in.
578020	3705-6	Black	500 ft.	3/8 in. x 7/8 in.
578040	3705-6	Black	150 ft.	3/8 in. x 7/8 in. x 1/2 in. Flap
578021	3705-6	Gray	500 ft.	3/8 in. x 7/8 in.
578032	3105-6	White	500 ft.	5/16 in. x 13/16 in.
578052	3105-6	White	150 ft.	5/16 in. x 13/16 in. x 1/2 in. Flap



Xtreme Seal®

Xtreme Seal edge seal is a high-tech extrusion, engineered and manufactured with an advanced EPDM material. It's a closed-cell flexible material that can be glued or sewn to most materials and surfaces. The flexibility and unique design creates a three-point contact seal on most surfaces. Xtreme Seal is an ideal choice for an edge seal on all types of custom covers, such as convertible tops, side curtains, camper enclosures, windshield tops and sides, front-drop windshields, and deck seals. Sold in full rolls only.



ITEM #	STYLE #	COLOR	PUT UP	WIDTH
578056	POD6	Black	50 ft.	1.85 in.
578057	POD7	White	50 ft.	1.85 in.

Xtreme Seal® is a registered trademark of Xtreme Seal LLC.



Xtreme Seal® Ultra Seal

Xtreme Seal Ultra Seal is designed for a great edge seal. It works well with DOT® Common Sense® fasteners and gives a flatter finished profile. Sold in full rolls only.

ITEM #	STYLE #	COLOR	PUT UP	WIDTH
578051	POD9	Black	100 ft.	1.8 in.

Xtreme Seal® is a registered trademark of Xtreme Seal LLC. DOT® and Common Sense® are registered trademarks of Scovill, Inc.



Xtreme Seal® V-Seal

Xtreme V-Seal works well with all cutouts and tight corners, bow covers and radar arch cutouts. Sold in full rolls only.

ITEM #	STYLE #	COLOR	PUT UP	WIDTH
578050	POD13	White	100 ft.	0.691 in.
578053	POD11	Black	100 ft.	0.691 in.

Xtreme Seal® is a registered trademark of Xtreme Seal LLC.



Xtreme Seal® Awning Seal

Awning installations are a breeze with Xtreme Seal Awning Seal. Designed for the awning industry as a gasket material between the frame and the mounting surface, Xtreme Seal Awning Seal conforms to the contour of the mounting surface, eliminating the need for silicone and providing a clean finished product. Made of EPDM material, Xtreme Seal Awning Seal also features an adhesive back, saving time and making mounting easy.

ITEM #	STYLE #	COLOR	PUT UP
578054	POD-AW	Black	250 ft.

Xtreme Seal® is a registered trademark of Xtreme Seal LLC.



Thread – Aqua-Seal™

Aqua-Seal polyester thread and bobbins when used as a system provides a strong deterrent to seam leakage. Aqua-Seal thread is colorfast, UV resistant, and non-wicking. When Aqua-Seal thread is used with its pre-wound bobbin, it fills the needle holes as the fabric is stitched.

ITEM #	COLOR	PUT UP	SIZE
542031	Black	1 lbs. tubes, 2650 yd.	138 / T135
542001	Black	1 lbs. tubes, 3600 yd.	92+ / T110
542002	Natural Tan	1/2 lbs. tubes, 1800 yd.	92+ / T110
542030	White	1 lbs. tubes, 2650 yd.	138 / T135
542000	White	1 lbs. tubes, 3600 yd.	92+ / T110

Aqua-Seal™ is a trademark of Fil-Tec, Inc.



Thread – Coats Dabond® Nano

This thread provides all the strength characteristics as regular Dabond plus has an anti-wick finish that minimizes seam leakage.

ITEM #	DESCRIPTION	AVERAGE BREAKING STRENGTH	COLOR	COLOR #	PUT UP	SIZE
542378		22.6 lbs.	Beige	4620	8 oz. tube	V138
542338		14.5 lbs.	Beige	4620	8 oz. tube	V92
542558		22.6 lbs.	Black		16 oz. tube	V-138 (#12)
542530		14.5 lbs.	Black		16 oz. tube	V-92 (#16)
542336		14.5 lbs.	Black	4608	8 oz. tube	V92
542388		22.6 lbs.	Burgundy	4631	8 oz. tube	V138
542346		14.5 lbs.	Cadet Gray	4630	8 oz. tube	V92
542392		22.6 lbs.	Forest Green	4637	8 oz. tube	V138
542352		14.5 lbs.	Forest Green	4637	8 oz. tube	V92
542372		22.6 lbs.	Jockey Red	4603	8 oz. tube	V138
542332		14.5 lbs.	Jockey Red	4603	8 oz. tube	V92
542390		22.6 lbs.	Linen	4633	8 oz. tube	V138
542350		14.5 lbs.	Linen	4633	8 oz. tube	V92
542334		14.5 lbs.	Natural	4604	8 oz. tube	V92
542330		14.5 lbs.	Pacific Blue	4601	8 oz. tube	V92
542380		22.6 lbs.	Terra Cotta	4622	8 oz. tube	V138
542384		22.6 lbs.	Toast	4628	8 oz. tube	V138
542557		22.6 lbs.	White		16 oz. tube	V-138 (#12)
542526		10.9 lbs.	White		16 oz. tube	V-69 (#24)
542532	Anti-Wick	14.5 lbs.	White		16 oz. tube	V-92 (#16)
542543		14.5 lbs.	White		16 oz. tube	V-92

Dabond® is a registered trademark of J. & P. Coats, Limited.



Thread – Coats Dual Duty®

Dual Duty is “core”-type thread made by spinning a high-grade cotton warp around a continuous multi-filament polyester core. Low shrinkage as compared to cotton, high single end strength, stronger seams than with cotton of equivalent size, and excellent resistance to abrasion. When wet, cotton swells to fill needle holes in fabric, which reduces seam leakage.

ITEM #	COLOR	PUT UP	SIZE
551952	Natural	1-1/2 lb. cones, 5,000 yd./cone, 18/box	150

Dual Duty® is a registered trademark of J. & P. Coats, Limited.



Thread – Coats Nymo® UVR Nylon Monocord

Not recommended for outdoor use.

ITEM #	APPROX. YARDS PER POUND	AVERAGE BREAKING STRENGTH	COLOR	PUT UP	SIZE
552001	4100	15.5 lbs.	Natural	1 lb. tubes, 40/box	EE
552002	3200	19 lbs.	Natural	1 lb. tubes, 40/box	FF

Nymo® is a registered trademark of J. & P. Coats, Limited.



Thread – Coats Polymatic® Drip Stop Bonded Monocord Dacron®

Polymatic Drip-Stop inhibits the capillary action that causes seam leakage. Where seam leakage would detract from the utility of the end product, specify this thread.

ITEM #	APPROX. YARDS PER POUND	AVERAGE BREAKING STRENGTH	COLOR	PUT UP	SIZE
551906	3500	18 lbs.	Black	1 lb. tubes, 40/box	125
551916	3800	18 lbs.	Black	1 lb. tubes, 40/box	FF
551905	3500	18 lbs.	White	1 lb. tubes, 40/box	125
551915	3800	18 lbs.	White	1 lb. tubes, 40/box	FF

Polymatic® is a registered trademark of J. & P. Coats, Limited. Dacron® is a registered trademark of INVISTA™.



Thread – Coats Polymatic® Bonded Monocord Dacron®

A bonded monocord Dacron thread treated for maximum resistance to UV degradation. This thread has increased lubrication to protect the thread during the sewing process. Stronger than twisted threads, therefore a smaller thread size can be used. Less prone to ravel and knot during sewing. Its oval profile reduces exposure of thread to surface abrasion. Can be used on both sides of double needle machine.

ITEM #	STYLE #	APPROX. YARDS PER POUND	AVERAGE BREAKING STRENGTH	COLOR	PUT UP	SIZE
551943		3572	18 lbs.	Ashes	1 lb. tubes, 40/box	125
551931		3500	18 lbs.	Beige	8 oz. tubes, 100/box	125
551938		3783	15.5 lbs.	Beige	1 lb. tubes, 40/box	FF
551926		3572	18 lbs.	Black	1 lb. tubes, 40/box	125
551917		2800	22 lbs.	Black	1 lb. tubes, 40/box	160
551936		3783	15.5 lbs.	Black	1 lb. tubes, 40/box	FF
551928		3572	18 lbs.	Blue	1 lb. tubes, 40/box	125
551929		3572	18 lbs.	Brown	1 lb. tubes, 40/box	125
551933		3500	18 lbs.	Burgundy	8 oz. tubes, 100/box	125
551947		3572	18 lbs.	Cameleon Grey	1 lb. tubes, 40/box	125
551922		3572	18 lbs.	Grey	1 lb. tubes, 40/box	125
551946		3572	18 lbs.	Indigo	1 lb. tubes, 40/box	125
552000		3572	18 lbs.	Lark	1 lb. tubes, 40/box	125
551927		3572	18 lbs.	Olive Drab	1 lb. tubes, 40/box	125
551921		3572	18 lbs.	Red	1 lb. tubes, 40/box	125
551924	S4234	3572	18 lbs.	Shoe Green	1 lb. tubes, 40/box	125
551942		3572	18 lbs.	Tan	1 lb. tubes, 40/box	125
551930	S5044P	3572	18 lbs.	Turf Green	1 lb. tubes, 40/box	125
551925		3572	18 lbs.	White	1 lb. tubes, 40/box	125
551919		2800	22 lbs.	White	1 lb. tubes, 40/box	160
551935		3783	15.5 lbs.	White	1 lb. tubes, 40/box	FF

Polymatic® is a registered trademark of J. & P. Coats, Limited. Dacron® is a registered trademark of INVISTA™.



Thread – Coats Ultra Dee® Polyester

A corded thread made from a high strength, resilient and continuous filament polyester. Heat set to minimize shrinkage or stretch. The bonded finish adds strength and reduces fraying at needle eye. All are left twist threads.

ITEM #	DESCRIPTION	APPROX. YARDS PER TUBE	AVERAGE BREAKING STRENGTH	COLOR	PUT UP	SIZE
541826	Bonded	1147	14.2 lbs.	Ashes	4 oz. tubes, 10/box	DB92 (#16)
541326	Bonded	4141	14.2 lbs.	Beaver	1 lb. tubes, 50/box	DB92 (#16)
541805	Bonded	1147	14.2 lbs.	Beaver	4 oz. tubes, 10/box	DB92 (#16)
541322	Bonded	2913	21.4 lbs.	Black	1 lb. tubes, 50/box	DB138 (#12)
541325	Bonded	5549	10.5 lbs.	Black	1 lb. tubes, 50/box	DB69 (#24)
541323	Bonded	4141	14.2 lbs.	Black	1 lb. tubes, 50/box	DB92 (#16)
541816	Bonded	1147	14.2 lbs.	Black	4 oz. tubes, 10/box	DB92 (#16)
541213	Gral Anti-Static Finish	3100	21.4 lbs.	Black	1 lb. tubes, 50/box	138 (#12)
542415	Gral Anti-Static Finish	5549	10.5 lbs.	Black	1 lb. tubes, 50/box	69 (#24)
541613	Gral Anti-Static Finish	4140	14.2 lbs.	Black	1 lb. tubes, 50/box	92 (#16)
541817	Bonded	1147	14.2 lbs.	Blue	4 oz. tubes, 10/box	DB92 (#16)
541823	Bonded	1147	14.2 lbs.	Chocolate Brown	4 oz. tubes, 10/box	DB92 (#16)
541808	Bonded	1147	14.2 lbs.	Gold	4 oz. tubes, 10/box	DB92 (#16)
541809	Bonded	1147	14.2 lbs.	Hunter Green	4 oz. tubes, 10/box	DB92 (#16)
541803	Bonded	1147	14.2 lbs.	Malaga	4 oz. tubes, 10/box	DB92 (#16)
541821	Bonded	1147	14.2 lbs.	Medium Titanium	4 oz. tubes, 10/box	DB92 (#16)
541813	Bonded	1147	14.2 lbs.	Navy	4 oz. tubes, 10/box	DB92 (#16)
541319	Bonded	3100	21.4 lbs.	Olive Drab	1 lb. tubes, 50/box	DB138 (#12)
541352	Bonded	1035	14 lbs.	Olive	1 lb. tubes, 50/box	DB138
541815	Bonded	1147	14.2 lbs.	Peasant Beige	4 oz. tubes, 10/box	DB92 (#16)
541830	Bonded	1147	14.2 lbs.	Pebble	4 oz. tubes, 10/box	DB92
541800	Bonded	1147	14.2 lbs.	Red	4 oz. tubes, 10/box	DB92 (#16)
541356	Bonded	1035	14 lbs.	Rhonda Blue	1 lb. tubes, 50/box	DB138
541844	Bonded	1147	14.2 lbs.	Ripe Raisin	4 oz. tubes, 10/box	DB92
541831	Bonded	1147	14.2 lbs.	Sand	4 oz. tubes, 10/box	DB92 (#16)
541842	Bonded	1147	14.2 lbs.	Spruce	4 oz. tubes, 10/box	DB92 (#16)
541357	Bonded	1035	14 lbs.	Steel Grey	1 lb. tubes, 50/box	DB138
541832	Bonded	1035	14 lbs.	Suntan	4 oz. tubes, 10/box	DB92
541818	Bonded	1147	14.2 lbs.	Terra Cotta	4 oz. tubes, 10/box	DB92 (#16)
541320	Bonded	2913	21.4 lbs.	White	1 lb. tubes, 50/box	DB138 (#12)
542102	Bonded	1876	31.4 lbs.	White	1 lb. tubes, 50/box	DB207 (#4)
541324	Bonded	5549	10.5 lbs.	White	1 lb. tubes, 50/box	DB69 (#24)
541321	Bonded	4141	14.2 lbs.	White	1 lb. tubes, 50/box	DB92 (#16)
541838	Bonded	1147	14.2 lbs.	White	4 oz. tubes, 10/box	DB92
541214	Gral Anti-Static Finish	3100	21.4 lbs.	White	1 lb. tubes, 50/box	138 (#12)
542414	Gral Anti-Static Finish	5549	10.5 lbs.	White	1 lb. tubes, 50/box	69 (#24)
541614	Gral Anti-Static Finish	4140	14.2 lbs.	White	1 lb. tubes, 50/box	92 (#16)

Ultra Dee® is a registered trademark of J. & P. Coats, Limited.



Thread – A&E Poly Nu Bond™ Twisted Non-Wick Polyester

Poly Nu Bond has superior strength, stretch and recovery properties and excellent resistance to chemicals, bacteria, mildew, wear and abrasion. This thread is made of quality, high tenacity, heat resistant, continuous filament yarn. Special waxes, silicones and oils are applied to lubricate the thread, reducing needle heat and increasing sewability. This also aids in the application of constant machine tension and good loop formation.

ITEM #	DESCRIPTION	APPROX. YARDS PER POUND	AVERAGE BREAKING STRENGTH	COLOR	COLOR #	PUT UP	SIZE
542453		2700	23 lbs.	Black	4608	1 lb. tubes	138
542455		5700	10 lbs.	Black	4608	1 lb. tubes	69
542451		4200	13.8 lbs.	Black	4608	1 lb. tubes	92
540305	Right Twist	2700	23 lbs.	Black		1 lb. tubes	138
540431		2700	23 lbs.	Burgundy	4631	1 lb. tubes	138
540631		4200	13.8 lbs.	Burgundy	4631	1 lb. tubes	92
540430		2700	23 lbs.	Cadet Gray	4630	1 lb. tubes	138
540705		5700	10 lbs.	Cadet Gray	4630	1 lb. tubes	69
540630		4200	13.8 lbs.	Cadet Gray	4630	1 lb. tubes	92
540334		2700	23.8 lbs.	Desert Tan		1 lb. tubes	138
540300		2700	23 lbs.	Erin Green	4600	1 lb. tubes	138
540437		2700	23 lbs.	Forest Green	4637	1 lb. tubes	138
540637		4200	13.8 lbs.	Forest Green	4637	1 lb. tubes	92
540706		5700	10 lbs.	Navy Blue	4626	1 lb. tubes	69
540346		2700	23 lbs.	Navy	4646	1 lb. tubes	138
540546		4200	13.8 lbs.	Navy	4646	1 lb. tubes	92
540433		2700	23 lbs.	New Linen	4633	1 lb. tubes	138
540633		4200	13.8 lbs.	New Linen	4633	1 lb. tubes	92
540439		2700	23 lbs.	Olive Drab		1 lb. tubes	138
540639		4200	13.8 lbs.	Olive Drab		1 lb. tubes	92
540301		2700	23 lbs.	Pacific Blue	4601	1 lb. tubes	138
540501		4200	13.8 lbs.	Pacific Blue	4601	1 lb. tubes	92
540403		2700	23 lbs.	Red	4603	1 lb. tubes	138
540603		4200	13.8 lbs.	Red	4603	1 lb. tubes	92
540620		4200	13.8 lbs.	Steel Gray		1 lb. tubes	92
540328		2700	23 lbs.	Toast	4628	1 lb. tubes	138
540704		5700	10 lbs.	Toast	4628	1 lb. tubes	69
540528		4200	13.8 lbs.	Toast	1628	1 lb. tubes	92
540321		2700	23 lbs.	True Brown	4621	1 lb. tubes	138
540521		4200	13.8 lbs.	True Brown	4621	1 lb. tubes	92
542452		2700	23 lbs.	White		1 lb. tubes	138
542454		5700	10 lbs.	White		1 lb. tubes	69
542450		4200	13.8 lbs.	White		1 lb. tubes	92
540304	Right Twist	2700	23 lbs.	White		1 lb. tubes	138

Poly Nu Bond™ is a trademark of American & Efird Enterprises, Inc.



Thread – Premofast™

A colorfast and fade resistant polyester thread.

ITEM #	DESCRIPTION	APPROX. YARDS PER POUND	AVERAGE BREAKING STRENGTH	COLOR	PUT UP	SIZE
542901		2800	23 lbs.	Black	1 lb. spool	WS138
542946		3600	18 lbs.	Black	1 lb. spool	WS92+
542960		3600	18 lbs.	Burgundy	1/2 lb. spool	WS92+
542980	Poly Bonded Monocord	3600	18 lbs.	Forest Green	1/2 lb. spool	WS92+
542957		3600	18 lbs.	Marine Blue	1/2 lb. spool	WS92+
542955		3600	18 lbs.	Natural Tan	1/2 lb. spool	WS92+
542956		3600	18 lbs.	Ruby Red	1/2 lb. spool	WS92+
542962		3600	18 lbs.	Steel Gray	1 lb. spool	WS92+
542900		2800	23 lbs.	White	1 lb. spool	WS138
542945		3600	18 lbs.	White	1 lb. spool	WS92+

THREAD MANUFACTURER’S CAUTION: Every possible care is exercised to furnish colors of proper fastness for the particular work involved, however, inasmuch as conditions of use (i.e. contrast stitching, volatile environments, etc), washing, cleaning, pressing, etc., vary considerably in thread usage, the buyer should ensure by prior experimentation that the dye fastness of the thread is suitable for the purpose. Almost no thread is 100% colorfast under all circumstances. Vinyls contain plasticizers which can promote color bleeding. As the cost of the thread is so disproportionate to the value of the goods onto which it is sewn, in the unlikely event of a claim, we are not responsible for consequential damages.

Premofast™ is a trademark of Fil-Tec, Inc.



Thread – A&E Special

ITEM #	DESCRIPTION	APPROX. YARDS PER TUBE	COLOR	MATERIAL	PUT UP	SIZE
542753	Bonded	5923	Black	Nylon	16 oz. tubes, 40/case	69
542750	Bonded	5923	White	Nylon	16 oz. tubes, 40/case	69



Thread – A&E SunStop®

Designed for the outdoor market, SunStop thread is made of 100% continuous filament polyester with enhanced UV and fade protection and a non-wicking finish. Use SunStop for outdoor applications requiring UV protection, such as tents, awnings, and canvas and marine applications.

ITEM #	STYLE #	COLOR	PUT UP	SIZE
540266	66503	Beige	1350 yd.	T135
540207	66503	Beige	2100 yd.	T90
540275	66501	Black	1350 yd.	T135
540277	66501	Black	2700 yd.	T135
540216	66501	Black	2100 yd.	T90
540231	66501	Black	4200 yd.	T90
540271	66504	Burgundy	1350 yd.	T135
540212	66504	Burgundy	2100 yd.	T90
540263	66511	Cadet Grey	1350 yd.	T135
540204	66511	Cadet Grey	1350 yd.	T90
540273	66518	Captain Navy	1350 yd.	T135
540214	66518	Captain Navy	2100 yd.	T90
550543	66518	Captain Navy	4200 yd.	T90
540268	66506	Forest Green	1350 yd.	T135
540209	66506	Forest Green	2100 yd.	T90
540270	66507	Jockey Red	1350 yd.	T135
540211	66507	Jockey Red	2100 yd.	T90
540264	66517	Linen	1350 yd.	T135
540205	66517	Linen	2100 yd.	T90
550539	66517	Linen	4200 yd.	T90
540269	66519	Logo Red	1350 yd.	T135
550546	66519	Logo Red	2700 yd.	T135
540210	66519	Logo Red	2100 yd.	T90
550541	66519	Logo Red	4200 yd.	T90
540261	66502	Natural	1350 yd.	T135
540202	66502	Natural	1350 yd.	T90
540274	66508	Navy	1350 yd.	T135
540215	66508	Navy	2100 yd.	T90
550544	66508	Navy	4200 yd.	T90
540272	66513	Pacific Blue	1350 yd.	T135
540213	66513	Pacific Blue	2100 yd.	T90
550542	66513	Pacific Blue	4200 yd.	T90
540262	66509	Silver	1350 yd.	T135
540203	66509	Silver	2100 yd.	T90
540265	66512	Toast	1350 yd.	T135
540206	66512	Toast	2100 yd.	T90
540267	66510	True Brown	1350 yd.	T135
550545	66510	True Brown	2700 yd.	T135
540208	66510	True Brown	2100 yd.	T90
550540	66510	True Brown	4200 yd.	T90
540260	66500	White	1350 yd.	T135
540276	66500	White	2700 yd.	T135
540201	66500	White	2100 yd.	T90
540230	66500	White	4200 yd.	T90

SunStop® is a registered trademark of American & Efrid Enterprises, Inc.



Thread – Gore® Tenara® (Original Style)

Gore Tenara Sewing Thread has unique properties. This thread is unaffected by sunlight. UV radiation will not weaken or degrade it. Polyester threads, under daily sunlight exposure will lose as much as half their strength in as little as one year, and be down to 10% of their original strength in 3 years. Tenara maintains its strength and color indefinitely. Gore Tenara Sewing Thread will outlast the fabric that it is sewn into. Comes with a full warranty to that effect. It is unaffected by canvas cleaning solutions and will not stain, rot or mildew. Dirt just wipes off. Using Gore Tenara Sewing Thread means seams that will last.

Tenara Sewing Thread Original Style is the first generation of Tenara outdoor sewing thread. The Original Style sewing thread is un-lubricated, with an elongation (or stretch) of five to seven percent.

ITEM #	STYLE #	APPROX. YARDS PER TUBE	COLOR	NOMINAL BREAKING STRENGTH	PUT UP	SIZE
552211	M1000-HBK	1775	Black	22 lbs.	1 lb. spools	138
552231	M1000HBK-5	950	Black	22 lbs.	1/2 lb. spools	138
552201	M1000-BK	3825	Black	12 lbs.	1 lb. spools	92
552221	M1000BK-5	1900	Black	12 lbs.	1/2 lb. spools	92
552210	M1000H	1900	White	25 lbs.	1 lb. spools	138
552230	M1000H-5	950	White	25 lbs.	1/2 lb. spools	138
552200	M1000	3825	White	14 lbs.	1 lb. spools	92
552220	M1000-5	1900	White	14 lbs.	1/2 lb. spools	92

FOR INDUSTRIAL USE ONLY. Not for use in food, drug, cosmetic, or medical device manufacturing, processing, or packaging operations.

Gore® and Tenara® are registered trademarks of W. L. Gore and Associates.



Thread – Gore® Tenara® (TR Style)

Gore Tenara Sewing Thread TR style builds on the features of the Original Style, but increases the choice of colors, as well as improving the sewability features. TR style comes in highly popular clear, providing a translucent thread that disappears into most fabrics, making color matching headaches go away. The patented TR style sewing thread has an elongation (or stretch) of approximately seventeen percent, making it more robust, which allows faster sewing. The TR style is lubricated with a silicone solution in all but the largest style.

ITEM #	STYLE #	APPROX. YARDS PER TUBE	COLOR	NOMINAL BREAKING STRENGTH	PUT UP	SIZE
552264	M1000TR-CB5	1900	Bay Blue	8 lbs.	1/2 lb. spools	92
552275	M1000TR-BK5	1900	Black	8 lbs.	1/2 lb. spools	92
552290	M1000LTR-L-5	2300	Clear	7 lbs.	1/2 lb. spools	69
553090	M1000KTR-L5	1900	Clear	10 lbs.	1/2 lb. spools	92
552265	M1000TR-FG5	1900	Forest Green	8 lbs.	1/2 lb. spools	92
552261	M1000TR-LG5	1900	Light Grey	8 lbs.	1/2 lb. spools	92
552263	M1000TR-RD5	1900	Red	8 lbs.	1/2 lb. spools	92
552262	M1000TR-TN5	1900	Sandstone (Tan)	8 lbs.	1/2 lb. spools	92
552274	M1000TR-WH5	1900	White	8 lbs.	1/2 lb. spools	92

FOR INDUSTRIAL USE ONLY. Not for use in food, drug, cosmetic, or medical device manufacturing, processing, or packaging operations.

Gore® and Tenara® are registered trademarks of W. L. Gore and Associates.

Thread – Gore® Tenara® (HTR Style)

Tenara HTR Heavy sewing thread is made of the same material as other Tenara threads, but features a unique 3-ply bonded construction that offers several advantages:

An “improved circular cross-section” that provides a smoother and more uniform appearance.

An increased twist level, which should reduce breaks.

Excellent sewability.

Softer construction. In addition, because of the new construction the thread is smoother on the tube, which allows for up to 15% more seam length for the same tube price as the previous HTR-style thread. The strength of the thread remains the same.

ITEM #	STYLE #	APPROX. YARDS PER TUBE	COLOR	NOMINAL BREAKING STRENGTH	PUT UP	SIZE
553094	M1003-HTR-BK-5	1150	Black	14 lbs.	1/2 lb. spools	138
553099	M1003-HTR-GY-5	1150	Charcoal Grey	14 lbs.	1/2 lb. spools	138
553097	M1003-HTR-CB-5	1150	Chesapeake Bay Blue	14 lbs.	1/2 lb. spools	138
553092	M1003-HTR-L-5	1150	Clear	19 lbs.	1/2 lb. spools	138
553096	M1003-HTR-FG-5	1150	Forest Green	14 lbs.	1/2 lb. spools	138
553095	M1003-HTR-LG-5	1150	Light Grey	14 lbs.	1/2 lb. spools	138
553093	M1003-HTR-WH-5	1150	White	14 lbs.	1/2 lb. spools	138

FOR INDUSTRIAL USE ONLY. Not for use in food, drug, cosmetic, or medical device manufacturing, processing, or packaging operations.

Gore® and Tenara® are registered trademarks of W. L. Gore and Associates.

Bobbins – Aqua-Seal™

Aqua-Seal polyester thread and bobbins when used as a system provides a strong deterrent to seam leakage. Aqua-Seal thread is colorfast, UV resistant, and non-wicking. When Aqua-Seal thread is used with its pre-wound bobbin, it fills the needle holes as the fabric is stitched.

ITEM #	STYLE #	COLOR	PUT UP	SIZE
542060	G	White	72/box	92+ / T110

Aqua-Seal™ is a trademark of Fil-Tec, Inc.



Bobbins – Coats Dual Duty®

Dual Duty is “core” -type thread made by spinning a high-grade cotton warp around a continuous multi-filament polyester core. Low shrinkage as compared to cotton, high single end strength, stronger seams than with cotton of equivalent size, and excellent resistance to abrasion. When wet, cotton swells to fill needle holes in fabric, which reduces seam leakage.

ITEM #	STYLE #	APPROX. YARDS PER BOBBIN	COLOR	PUT UP	SIZE
552150	G	15	Natural	1 gr. box	150 (#12)

Dual Duty® is a registered trademark of J. & P. Coats, Limited.



Bobbins – Coats Ultra Dee® Polyester

ITEM #	STYLE #	APPROX. YARDS PER BOBBIN	COLOR	PUT UP	SIZE
551652	G	25	Beaver	1 gr. box, 30/box	92
551263	G	17	Black	1 gr. box, 30/box	138
551202	M	24	Black	1 gr. box, 30/box	138
551201	U	49	Black	1 gr. box, 30/box	138
551813	F	29	Black	1 gr. box, 30/box	69
551660	G	25	Black	1 gr. box, 30/box	92
551763	M	36	Black	1 gr. box, 30/box	92
551254	G	17	Olive Drab	1 gr. box, 30/box	138
551264	G	17	White	1 gr. box, 30/box	138
551265	M	24	White	1 gr. box, 30/box	138
551200	U	49	White	1 gr. box, 30/box	138
542103	58	37	White	1 gr. box, 30/box	207
551814	F	29	White	1 gr. box, 30/box	69
551664	G	25	White	1 gr. box, 30/box	92
551764	M	36	White	1 gr. box, 30/box	92

Ultra Dee® is a registered trademark of J. & P. Coats, Limited.



Bobbins – Coats Polymatic® Belbobs® Bonded Monocord Dacron®

Shell-less bobbins.

ITEM #	STYLE #	APPROX. YARDS PER BOBBIN	COLOR	PUT UP	SIZE
551966	M	31	Ashes	80/box	125
551979	G	22	Beige	80/box	125
551991	G	27	Beige	80/box	FF
551963	G	22	Black	80/box	125
551967	M	31	Black	80/box	125
551983	U	42	Black	80/box	125
551986	G	27	Black	80/box	FF
552080	M	40	Black	80/box	FF
551950	M	31	Cameleon Grey	80/box	125
551972	G	22	Grey	80/box	125
551948	M	31	Indigo	80/box	125
551975	G	22	White	80/box	125
551980	M	31	White	80/box	125
551981	U	42	White	42/box	125
551985	G	27	White	80/box	FF
551999	M	40	White	80/box	FF

Belbobs® and Polymatic® are registered trademarks of J. & P. Coats, Limited. Dacron® is a registered trademark of INVISTA™.



Bobbins – Coats Dabond® Belbobs®

ITEM #	STYLE #	APPROX. YARDS PER BOBBIN	COLOR	PUT UP	SIZE
542580	S/M	24	Black	1 gr. box	138
542593	G	18	White	1 gr. box	138
542581	S/M	24	White	1 gr. box	138

Dabond® and Belbobs® are registered trademarks of J. & P. Coats, Limited.



Bobbins – Premofast™

Premofast bobbins are solution dyed and will not bleed. All bobbins are sideless for maximum yield.

ITEM #	STYLE #	APPROX. YARDS PER BOBBIN	COLOR	PUT UP	SIZE
551432	G	22	Black	1 gr. box, 18/box	92+
551381	M	37	Black	1 gr. box, 18/box	WS92+
551431	G	22	White	1 gr. box, 18/box	92+
551380	M	37	White	1 gr. box, 18/box	WS92+

Premofast™ is a trademark of Fil-Tec, Inc.



Bobbins – A&E Poly Nu Bond™ Polyester

Ready-wound bobbins provide more thread per bobbin. The finish applied to the thread assures controlled delivery of the thread from the bobbin and contributes to a balanced stitch formation.

ITEM #	STYLE #	COLOR	PUT UP	SIZE
550302	S/G	Black	1 gr. box, 30/box	138
550353	S/M	Black	1 gr. box, 30/box	138
550101	S/G	Black	1 gr. box, 30/box	92
550252	S/M	Black	1 gr. box, 30/box	92
550300	S/G	White	1 gr. box, 30/box	138
550351	S/M	White	1 gr. box, 30/box	138
550100	S/G	White	1 gr. box, 30/box	92
550250	S/M	White	1 gr. box, 30/box	92

Poly Nu Bond™ is a trademark of American & Efird Enterprises, Inc.

Bobbins – SunStop®

ITEM #	STYLE #	COLOR	PUT UP	SIZE
550528	G	Beige	1 gr.	T135
550515	M	Beige	1 gr.	T135
550501	M	Beige	1 gr.	T90
550548	G	Black	1 gr.	T135
550509	M	Black	1 gr.	T135
550532	G	Burgundy	1 gr.	T135
550519	M	Burgundy	1 gr.	T135
550526	G	Cadet Grey	1 gr.	T135
550512	M	Cadet Grey	1 gr.	T135
550538	M	Captain Navy	1 gr.	
550535	G	Captain Navy	1 gr.	T135
550522	M	Captain Navy	1 gr.	T135
550530	G	Forest Green	1 gr.	T135
550517	M	Forest Green	1 gr.	T135
550531	G	Jockey Red	1 gr.	T135
550518	M	Jockey Red	1 gr.	T135
550527	G	Linen	1 gr.	T135
550513	M	Linen	1 gr.	T135
550533	G	Logo Red	1 gr.	T135
550520	M	Logo Red	1 gr.	T135
550524	G	Natural	1 gr.	T135
550536	G	Navy	1 gr.	T135
550523	M	Navy	1 gr.	T135
550534	G	Pacific Blue	1 gr.	T135
550521	M	Pacific Blue	1 gr.	T135
550525	G	Silver	1 gr.	T135
550511	M	Silver	1 gr.	T135
550502	M	Sol-Jet Black	1 gr.	T90
550514	M	Toast	1 gr.	T135
550537	M	Toast	1 gr.	T90
550529	G	True Brown	1 gr.	T135
550516	M	True Brown	1 gr.	T135
550547	G	White	1 gr.	T135
550510	M	White	1 gr.	T135
550500	M	White	1 gr.	T90

SunStop® is a registered trademark of American & Efird Enterprises, Inc.

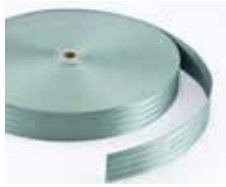

Polyfab™ Shade Sail Edge Webbing

Polyfab Shade Sail Edge Webbing is used for shade structures and shade sails. This polyester webbing has a breaking strength of approximately 4,700 pound force. Available to match Polytex®, Comtex® and Architec 400® extra heavy duty knitted Shadecloth. Available in full rolls only.

ITEM #	COLOR	COLOR #	PUT UP	WIDTH
565135	Antec Orange	22	109 yd.	2 in.
565129	Beige	72	109 yd.	2 in.
565137	Berry	36	109 yd.	2 in.
565121	Black	99	109 yd.	2 in.
565103	Blue	50	109 yd.	2 in.
565109	Bronze	81	109 yd.	2 in.
565131	Cafe Noir	35	109 yd.	2 in.
565113	Charcoal	92	109 yd.	2 in.
565141	Fluoro Green	67	109 yd.	2 in.
565118	Golden Yellow	11	109 yd.	2 in.
565101	Midnight Green	62	109 yd.	2 in.
565105	Navy Blue	51	109 yd.	2 in.
565115	Porcelain	71	109 yd.	2 in.
565139	Purple	58	109 yd.	2 in.
565127	Red	30	109 yd.	2 in.
565111	Sage	19	109 yd.	2 in.
565107	Sandstone	73	109 yd.	2 in.
565125	Silver Gray	91	109 yd.	2 in.
565119	Turquoise	10	109 yd.	2 in.
565133	White	01	109 yd.	2 in.

Polyfab™ is a trademark of Polyfab USA. Polytex®, Comtex® and Architec 400® are registered trademarks of Polyfab USA.



Sunbrella® Webbing

Sunbrella webbing made of 78% Sunbrella Acrylic and 22% high-tenacity polyester. A strong, weather-resistant webbing. Retains more tensile strength than other types of webbing after exposure to sunlight. Compatible with Sunbrella fabric colors. Available in full rolls only.

ITEM #	STYLE #	AVERAGE BREAKING STRENGTH	COLOR	PUT UP	WIDTH
577502	70-1654	1000 lbs.	Black	25 yd.	1 in.
577503	70-1654	1000 lbs.	Grey	25 yd.	1 in.
577500	70-1654	1000 lbs.	Pacific Blue	25 yd.	1 in.
577501	70-1654	1000 lbs.	White	25 yd.	1 in.

Sunbrella® is a registered trademark of Glen Raven, Inc.



Webbing – Nylon

Strong, dependable nylon webbing. Ideal for use with synthetic fabrics. Available in full rolls only.

ITEM #	STYLE #	DESCRIPTION	AVERAGE BREAKING STRENGTH	COLOR	PUT UP	WIDTH
575234	20616		1200 lbs.	Black	100 yd.	1 in.
575125	7207		1600 lbs.	Black	100 yd.	1 in.
575243	N0025		3698 lbs.	Black	50 yd.	1-1/2 in.
575241	N0025		3700 lbs.	Black	50 yd.	1 in.
574905	N0015CD		1720 lbs.	Black	50 yd.	1 in.
575075	N0085		7600 lbs.	Black	50 yd.	2 in.
574967	N0015S		1200 lbs.	Black	50 yd.	3/4 in.
574908	N0015S		1323 lbs.	Black	50 yd.	1-1/2 in.
575109	N0019		4200 lbs.	Black	50 yd.	1 in.
575011	N0019		3300 lbs.	Black	50 yd.	3/4 in.
574957	N0030		2400 lbs.	Black	50 yd.	1 in.
574912	N0015		2564 lbs.	Black	50 yd.	2 in.
575250	20614		2400 lbs.	Black	50 yd.	2 in.
575249	N0025		6200 lbs.	Black	50 yd.	2 in.
575113	NN075		4965 lbs.	Black	50 yd.	2 in.
575030	N0019		5890 lbs.	Black	50 yd.	1-1/2 in.
576110	N0006		6000 lbs.	Black	50 yd.	1 in.
575260	N0023S		1200 lbs.	Black	50 yd.	1 in.
575073	N0095		4200 lbs.	Black	50 yd.	1 in.
575076	N0072		9000 lbs.	Black	50 yd.	1-3/4 in.
575111	N0028	Tubular	4000 lbs.	Black	50 yd.	1 in.
574999	N0090	Tubular	2400 lbs.	Black	50 yd.	3/4 in.
575018	N0019		4200 lbs.	Brown	50 yd.	1 in.
574936	N0019		3850 lbs.	Brown	50 yd.	1 in.
575153	12304		1400 lbs.	Natural	50 yd.	1 in.
575014	N0019		4200 lbs.	Navy	50 yd.	1 in.
575013	N0019		4200 lbs.	Red	50 yd.	1 in.
575012	N0019		4200 lbs.	Silver	50 yd.	1 in.
575017	N0019		4200 lbs.	White	50 yd.	1 in.
575240	N0025		3400 lbs.	White	50 yd.	1 in.
575072	N0095		4200 lbs.	White	50 yd.	1 in.
575259	N0023		1580 lbs.	White	50 yd.	1 in.
575079	N0087		6000 lbs.	White	50 yd.	2 in.
574906	N0015CD		1720 lbs.	White	50 yd.	1 in.
575010	N0019		3300 lbs.	White	50 yd.	3/4 in.
575023	N0019		4200 lbs.	Yellow	50 yd.	1 in.

Webbing – Dacron®

Resistant to mildew, ultraviolet rays and shrinkage. Available in full rolls only.

ITEM #	STYLE #	AVERAGE BREAKING STRENGTH	COLOR	PUT UP	WIDTH
576633	S0009	740 lbs.	White	50 yd.	1-1/2 in.
576634	S0009	740 lbs.	White	50 yd.	2 in.

Dacron® is a registered trademark of INVISTA.



Webbing – Polyester

Resistant to mildew, ultraviolet rays and shrinkage. Excellent for reinforcing swimming pool covers – both screen or solid vinyl types. Available in full rolls only.

ITEM #	STYLE #	DESCRIPTION	AVERAGE BREAKING STRENGTH	COLOR	PUT UP	WIDTH
575299	R7624		6775 lbs.	Black	100 yd.	2 in.
575231	T-1200		6000 lbs.	Black	200 yd.	2 in.
575327	U0017			Black	50 yd.	1 in.
575135	T-1200		6000 lbs.	Natural	225 yd.	2 in.
575302	2070/S0009	Spun	740 lbs.	White	50 yd.	1 in.
575334	U0025			White	50 yd.	2 in.



Webbing – Heat-Sealable PVC

A general-purpose webbing with many applications. Not recommended for outdoor use. Sold in full rolls only.

ITEM #	STYLE #	AVERAGE BREAKING STRENGTH	COLOR	PUT UP	WIDTH
577907	1281	2900 lbs.	White	110 yd.	1-7/8 in.



Webbing – Polypropylene Style No. 7166/P0001

A general-purpose webbing with many applications. Not recommended for outdoor use. Sold in full rolls only.

ITEM #	STYLE #	AVERAGE BREAKING STRENGTH	COLOR	PUT UP	WIDTH
576036	549	600 lbs.	Black	100 yd.	1 in.
576501	7166/P0001	600 lbs.	Black	100 yd.	1 in.
576558	7166/P0001	600 lbs.	Black	100 yd.	1-1/2 in.
576460	7166/P0001	600 lbs.	Black	100 yd.	1/2 in.
576597	7166/P0001	600 lbs.	Black	100 yd.	2 in.
576639	7166/P0001	600 lbs.	Black	100 yd.	3 in.
576503	7166/P0001	600 lbs.	Black	100 yd.	3/4 in.
576021	PP037	600 lbs.	Black	100 yd.	1 in.
576553	7166/P0001	600 lbs.	Blue	100 yd.	1-1/2 in.
576598	7166/P0001	600 lbs.	Blue	100 yd.	2 in.
576543	7166/P0001	600 lbs.	Brown	100 yd.	1 in.
576531	7166/P0001	600 lbs.	Burgundy	100 yd.	1 in.
576470	7166/P0001	600 lbs.	Dark Beige	100 yd.	1 in.
576662	7166/P0001	600 lbs.	Dark Beige	100 yd.	2 in.
576490	7166/P0001	600 lbs.	Forest Green	100 yd.	1 in.
576663	7166/P0001	600 lbs.	Forest Green	100 yd.	2 in.
576529	7166/P0001	600 lbs.	Gray	100 yd.	1 in.
576540	7166/P0001	600 lbs.	Green	100 yd.	1 in.
576606	7166/P0001	600 lbs.	Green	100 yd.	2 in.
576537	7166/P0001	600 lbs.	Light Gold	100 yd.	1 in.
576601	7166/P0001	600 lbs.	Light Navy	100 yd.	2 in.
576031	7166/P0001	600 lbs.	Navy	100 yd.	1 in.
576533	7166/P0001	600 lbs.	Orange	100 yd.	1 in.
576613	7166/P0001	600 lbs.	Orange	100 yd.	2 in.
576541	7166/P0001	600 lbs.	Red	100 yd.	1 in.
576551	7166/P0001	600 lbs.	Red	100 yd.	1-1/2 in.
576599	7166/P0001	600 lbs.	Red	100 yd.	2 in.
576538	7166/P0001	600 lbs.	Silver	100 yd.	1 in.
576604	7166/P0001	600 lbs.	Silver	100 yd.	2 in.
576474	7166/P0001	600 lbs.	Tan	100 yd.	1 in.
576492	7166/P0001	600 lbs.	Victoria Blue	100 yd.	1 in.
576500	7166/P0001	600 lbs.	White	100 yd.	1 in.
576557	7166/P0001	600 lbs.	White	100 yd.	1-1/2 in.
576596	7166/P0001	600 lbs.	White	100 yd.	2 in.
576638	7166/P0001	600 lbs.	White	100 yd.	3 in.
576450	7166/P0001	600 lbs.	White	100 yd.	3/4 in.
576020	PP037	600 lbs.	White	100 yd.	1 in.
576542	7166/P0001	600 lbs.	Yellow	100 yd.	1 in.
576605	7166/P0001	600 lbs.	Yellow	100 yd.	2 in.



Webbing – Polypropylene Style No. 7390/P0002

A general-purpose webbing with many applications. Not recommended for outdoor use. Sold in full rolls only.

ITEM #	STYLE #	AVERAGE BREAKING STRENGTH	COLOR	PUT UP	WIDTH
576561	7390/P0002	800 lbs.	Black	100 yd.	1 in.
576582	7390/P0002	800 lbs.	Black	100 yd.	1-1/2 in.
576595	7390/P0002	800 lbs.	Black	100 yd.	2 in.
576617	7390/P0002	800 lbs.	Black	100 yd.	3 in.
576670	7390/P0002	800 lbs.	Black	100 yd.	3/4 in.
576564	7390/P0002	800 lbs.	Blue	100 yd.	1 in.
576688	7390/P0002	800 lbs.	Dark Beige	100 yd.	1-1/2 in.
576685	7390/P0002	800 lbs.	Forest Green	100 yd.	1-1/2 in.
576589	7390/P0002	800 lbs.	Grape	100 yd.	1 in.
576703	7390/P0002	800 lbs.	Gray Pattern	100 yd.	3/4 in.
576620	7390/P0002	800 lbs.	Gray	100 yd.	1 in.
576702	7390/P0002	800 lbs.	Gray	100 yd.	1-1/2 in.
576565	7390/P0002	800 lbs.	Green	100 yd.	1 in.
576570	7390/P0002	800 lbs.	Light Navy	100 yd.	1 in.
576566	7390/P0002	800 lbs.	Red	100 yd.	1 in.
576695	7390/P0002	800 lbs.	Red	100 yd.	1-1/2 in.
576621	7390/P0002	800 lbs.	Silver	100 yd.	1 in.
576583	7390/P0002	800 lbs.	Silver	100 yd.	1-1/2 in.
576623	7390/P0002	800 lbs.	Tan	100 yd.	1 in.
576560	7390/P0002	800 lbs.	White	100 yd.	1 in.
576586	7390/P0002	800 lbs.	White	100 yd.	1-1/2 in.
576594	7390/P0002	800 lbs.	White	100 yd.	2 in.
576618	7390/P0002	800 lbs.	White	100 yd.	3 in.
576567	7390/P0002	800 lbs.	Yellow	100 yd.	1 in.



Webbing – Leader

An economical webbing for heavy-duty applications. Mixed colors and shade. Available in full rolls only.

ITEM #	AVERAGE BREAKING STRENGTH	COLOR	PUT UP	WIDTH
575136	5500 lbs.	Multi-Color	200 yd.	2 in.

Webbing – Cotton – Indo-Carbon Black – Class 3

This untreated cotton webbing is manufactured in accordance with Government Specifications MIL-W-530 and MIL-T-43566. The vat dyes are fast to washing with chlorine, hot pressing, perspiration and peroxides. Available in full rolls only.

ITEM #	STYLE #	MINIMUM BREAKING STRENGTH	PUT UP	WIDTH
573113	Type I	140 lbs.	100 yd.	5/8 in.

Webbing – Cotton – Natural – Class 1

This untreated cotton webbing is manufactured in accordance with Government Specifications MIL-W-530 and MIL-T-43566. The vat dyes are fast to washing with chlorine, hot pressing, perspiration and peroxides. Available in full rolls only.

ITEM #	STYLE #	MINIMUM BREAKING STRENGTH	PUT UP	WIDTH
572113	Type I	70 lbs.	100 yd.	1/2 in.
572115	Type I	85 lbs.	100 yd.	5/8 in.
572116	Type I	100 lbs.	100 yd.	3/4 in.
572120	Type I	130 lbs.	100 yd.	1 in.
572123	Type I	190 lbs.	100 yd.	1-1/2 in.
572130	Type I	250 lbs.	100 yd.	2 in.
572216	Type II A	230 lbs.	60 yd.	3/4 in.
572220	Type II A	300 lbs.	60 yd.	1 in.
572223	Type II A	440 lbs.	60 yd.	1-1/2 in.
572230	Type II A	580 lbs.	60 yd.	2 in.
572320	Type III	550 lbs.	60 yd.	1 in.
572323	Type III	860 lbs.	60 yd.	1-1/2 in.
572330	Type III	1100 lbs.	60 yd.	2 in.
572331	Type III N	1560 lbs.	50 yd.	3 in.

Webbing – Vat-Dyed Olive Drab – Shade 7 Untreated – Class 3

This cotton webbing is manufactured in accordance with Government Specifications MIL-W-530 and MIL-T-43566. The vat dyes are fast to washing with chlorine, hot pressing, perspiration and peroxides. Available in full rolls only.

ITEM #	STYLE #	MINIMUM BREAKING STRENGTH	PUT UP	WIDTH
573116	Type I	100 lbs.	100 yd.	3/4 in.
573120	Type I	130 lbs.	100 yd.	1 in.
573320	Type III	550 lbs.	60 yd.	1 in.
573323	Type III	860 lbs.	60 yd.	1-1/2 in.



Strapping – Furniture

Heavy cotton strapping woven for long wear and durability. Five added stitches across the width assure maximum strength. Double blue line down center for identification. A soft finish strapping designed especially for use in appliance and furniture moving industry. Won't mar polished surfaces. Sold in full rolls only.

ITEM #	STYLE #	AVERAGE BREAKING STRENGTH	COLOR	PUT UP	WIDTH
574601	W0068	975 lbs.	Natural	50 yd.	2 in.



Tape – Unbleached Cotton

An ideal low-cost tape for apron binding, tie tapes and finishing raw edges of other canvas specialties. Available in full rolls only.

ITEM #	STYLE #	DESCRIPTION	COLOR	PUT UP	WIDTH
572058		Heavy	Natural	72 yd.	1/2 in.
572112	B0078		Natural	100 yd.	1 in.

Braid – Nylon/Polyester Elastic

Available in full rolls only.

ITEM #	STYLE #	COLOR	MATERIAL	PUT UP	WIDTH
506172	S-2500	White	Nylon	36 yd.	3/4 in.
506197	1050	Black	Polyester	144 yd.	1 in.
506205	970	Black	Polyester	36 yd.	2 in.



TEXACRO® – Hook And Loop Tape – Standard Back

Heavy-duty hook and loop fasteners. A state-of-the-art manufacturing process produces this heavy-duty hook tape with high-performance characteristics. Napped loop is specifically designed to be used with the "aggressive" TEXACRO Hook for excellent latching performance and peel and shear strength. Available in full rolls only.

ITEM #	STYLE #	DESCRIPTION	BACKING	COLOR	PUT UP	WIDTH
580000	320030	Hook #70	Standard	Black	50 yd.	5/8 in.
580001	320031	Loop #71	Standard	Black	50 yd.	5/8 in.
580002	320020	Hook #70	Standard	White	25 yd.	5/8 in.
580003	320021	Loop #71	Standard	White	50 yd.	5/8 in.
580022	320022	Hook #70	Standard	White	50 yd.	3/4 in.
580023	320023	Loop #71	Standard	White	50 yd.	3/4 in.
580040	320034	Hook #70	Standard	Black	50 yd.	1 in.
580041	320035	Loop #71	Standard	Black	50 yd.	1 in.
580042	320024	Hook #70	Standard	White	50 yd.	1 in.
580043	320025	Loop #71	Standard	White	50 yd.	1 in.
580070	320036	Hook #70	Standard	Black	50 yd.	1-1/2 in.
580071	320037	Loop #71	Standard	Black	50 yd.	1-1/2 in.
580072	320026	Hook #70	Standard	White	50 yd.	1-1/2 in.
580073	320027	Loop #71	Standard	White	50 yd.	1-1/2 in.
580086	320053	Hook #70	Standard	Black	50 yd.	4 in.
580089	320058	Loop #71	Standard	Black	50 yd.	4 in.
580090	320038	Hook #70	Standard	Black	50 yd.	2 in.
580091	320039	Loop #71	Standard	Black	50 yd.	2 in.
580092	320028	Hook #70	Standard	White	50 yd.	2 in.
580093	320029	Loop #71	Standard	White	50 yd.	2 in.
580145	320906	Hook #70	Standard	Black	50 yd.	3 in.

TEXACRO® is a registered trademark of Velcro Industries B.V.

TEXACRO® – Hook And Loop Tape – Adhesive Back

Heavy-duty hook and loop fasteners. A state-of-the-art manufacturing process produces this heavy-duty hook tape with high-performance characteristics. Napped loop is specifically designed to be used with the “aggressive” TEXACRO Hook for excellent latching performance and peel and shear strength. Available in full rolls only.

ITEM #	STYLE #	DESCRIPTION	BACKING	COLOR	PUT UP	WIDTH
580050	320280	Hook #70	Adhesive	White	25 yd.	5/8 in.
580051	320298	Loop #71	Adhesive	White	25 yd.	5/8 in.
580052	320292	Hook #70	Adhesive	Black	25 yd.	5/8 in.
580053	320286	Loop #71	Adhesive	Black	25 yd.	5/8 in.
580056	320281	Hook #70	Adhesive	Black	25 yd.	3/4 in.
580082	320297	Hook #70	Adhesive	White	25 yd.	4 in.
580083	320303	Loop #71	Adhesive	White	25 yd.	4 in.
580084	320285	Hook #70	Adhesive	Black	25 yd.	4 in.
580085	320291	Loop #71	Adhesive	Black	25 yd.	4 in.
580094	320290	Loop #71	Adhesive	Black	25 yd.	2 in.
580095	320284	Hook #70	Adhesive	Black	25 yd.	2 in.
580096	320302	Loop #71	Adhesive	White	25 yd.	2 in.
580097	320300	Loop #71	Adhesive	White	25 yd.	1 in.
580098	320294	Hook #70	Adhesive	White	25 yd.	1 in.
580099	320296	Hook #70	Adhesive	White	25 yd.	2 in.
580103	320282	Hook #70	Adhesive	Black	25 yd.	1 in.
580104	320288	Loop #71	Adhesive	Black	25 yd.	1 in.
580105	320295	Hook #70	Adhesive	White	25 yd.	1-1/2 in.
580106	320301	Loop #71	Adhesive	White	25 yd.	1-1/2 in.
580107	320283	Hook #70	Adhesive	Black	25 yd.	1-1/2 in.
580108	320289	Loop #71	Adhesive	Black	25 yd.	1-1/2 in.
580139	320829	Loop #71	Standard	Black	25 yd.	3 in.

TEXACRO® is a registered trademark of Velcro Industries B.V.

VELCRO® Brand Hook And Loop Fasteners – Standard Back Nylon Tape

A woven tape fastener consisting of two mating strips. The Hook or male section is covered with stiff little hooks. The Loop or female section is covered with tiny soft loops. When pressed together the hooks and loops engage, creating an adjustable, highly versatile and secure closure. Sold in full rolls only.

ITEM #	STYLE #	DESCRIPTION	COLOR	PUT UP	WIDTH
580153	194202	Loop #1000	Beige	50 yd.	1 in.
580154	194154	Hook #88	Beige	50 yd.	1 in.
580200	191300	Hook #88	Black	50 yd.	5/8 in.
580201	194134	Hook #88	White	50 yd.	5/8 in.
580210	194144	Hook #88	Black	50 yd.	3/4 in.
580215	194145	Hook #88	Beige	50 yd.	3/4 in.
580216	194191	Loop #1000	Beige	50 yd.	3/4 in.
580220	193085	Hook #88	White	50 yd.	3/4 in.
580239	194702	Hook #88	Royal	50 yd.	1 in.
580250	194153	Hook #88	Black	50 yd.	1 in.
580251	193087	Hook #88	White	50 yd.	1 in.
580252	194705	Hook #88	Light Gray	50 yd.	1 in.
580256	193089	Hook #88	White	50 yd.	1-1/2 in.
580257	194164	Hook #88	Black	50 yd.	1-1/2 in.
580273	194178	Hook #88	Olive Green	50 yd.	2 in.
580275	194175	Hook #88	Black	50 yd.	2 in.
580276	193091	Hook #88	White	50 yd.	2 in.

ITEM #	STYLE #	DESCRIPTION	COLOR	PUT UP	WIDTH
580277	194579	Hook #88	Light Gray	50 yd.	2 in.
580279	194099	Hook #88	Beige	50 yd.	2 in.
580287	190806	Hook #88	White	25 yd.	4 in.
580288	190810	Hook #88	Black	25 yd.	4 in.
580300	194179	Loop #1000	Black	50 yd.	5/8 in.
580301	194096	Loop #1000	White	50 yd.	5/8 in.
580310	194190	Loop #1000	Black	50 yd.	3/4 in.
580315	197078	Hook #88	Battleship Grey	25 yd.	2 in.
580316	197077	Loop #1000	Battleship Grey	25 yd.	2 in.
580320	191301	Loop #1000	White	50 yd.	3/4 in.
580329	195966	Hook #88	Black	25 yd.	3 in.
580339	194577	Loop #1000	Royal Blue	50 yd.	1 in.
580346	193088	Loop #1000	White	50 yd.	1-1/2 in.
580350	194098	Loop #1000	Black	50 yd.	1 in.
580351	193086	Loop #1000	White	50 yd.	1 in.
580356	194212	Loop #1000	Black	50 yd.	1-1/2 in.
580373	194226	Loop #1000	Olive Green	50 yd.	2 in.
580375	194223	Loop #1000	Black	50 yd.	2 in.
580376	193090	Loop #1000	White	50 yd.	2 in.
580377	194580	Loop #1000	Light Gray	50 yd.	2 in.
580379	194100	Loop #1000	Beige	50 yd.	2 in.
580387	190795	Loop #1000	White	25 yd.	4 in.
580388	190799	Loop #1000	Black	25 yd.	4 in.
580461	195967	Loop #1000	Black	25 yd.	3 in.
580462	199497	Loop #1000	White	50 yd.	3 in.

VELCRO®, ONE-WRAP®, VELSTICK® and VELSTRETCH® are registered trademarks of Velcro BVBA. Used with permission.

VELCRO® Brand Hook And Loop Fasteners – Standard Back Polyester Tape

A woven tape fastener consisting of two mating strips. The Hook or male section is covered with stiff little hooks. The Loop or female section is covered with tiny soft loops. When pressed together the hooks and loops engage, creating an adjustable, highly versatile and secure closure. Available in full rolls only.

ITEM #	STYLE #	DESCRIPTION	COLOR	PUT UP	WIDTH
580229	159511	Hook #81	White	50 yd.	5/8 in.
580255	190579	Hook #81	White	25 yd.	1 in.
580265	190789	Hook #81	Black	25 yd.	2 in.
580278	190787	Hook #81	White	25 yd.	2 in.
580349	192076	Loop #009	White	25 yd.	5/8 in.
580355	190465	Loop #009	White	25 yd.	1 in.
580378	190711	Loop #009	White	25 yd.	2 in.
580700	190582	Hook #81	Black	25 yd.	1 in.
580701	190468	Loop #009	Black	25 yd.	1 in.
580702	190713	Loop #009	Black	25 yd.	2 in.
580705	172645	Hook #81	White	25 yd.	1-1/2 in.
580706	173646	Loop #009	White	25 yd.	1-1/2 in.

VELCRO®, ONE-WRAP®, VELSTICK® and VELSTRETCH® are registered trademarks of Velcro BVBA. Used with permission..

VELCRO® Brand Hook And Loop Fasteners – Adhesive Back Nylon Tape

A woven tape fastener consisting of two mating strips. The Hook or male section is covered with stiff little hooks. The Loop or female section is covered with tiny soft loops. When pressed together the hooks and loops engage, creating an adjustable, highly versatile and secure closure. Sold in full rolls only.

ITEM #	STYLE #	DESCRIPTION	COLOR	PUT UP	WIDTH
580192	196802	Hook #88	Black	25 yd.	1/2 in.
580193	196256	Loop #1000	Black	25 yd.	1/2 in.
580198	190836	Loop #1000	Black	25 yd.	5/8 in.
580209	190940	Hook #88	Black	25 yd.	3/4 in.
580258	191157	Hook #88	White	25 yd.	1-1/2 in.
580259	191166	Hook #88	Black	25 yd.	1-1/2 in.
580260	191051	Hook #88	Black	25 yd.	1 in.
580261	191033	Hook #88	White	25 yd.	1 in.
580282	191231	Hook #88	White	25 yd.	2 in.
580285	191245	Hook #88	Black	25 yd.	2 in.
580309	190911	Loop #1000	Black	25 yd.	3/4 in.
580311	190935	Hook #88	White	25 yd.	3/4 in.
580312	190899	Loop #1000	White	25 yd.	3/4 in.
580358	191129	Loop #1000	White	25 yd.	1-1/2 in.
580359	191140	Loop #1000	Black	25 yd.	1-1/2 in.
580360	190984	Loop #1000	Black	25 yd.	1 in.
580361	190959	Loop #1000	White	25 yd.	1 in.
580382	191181	Loop #1000	White	25 yd.	2 in.
580385	191195	Loop #1000	Black	25 yd.	2 in.
580460	183631	Hook #88	Black	25 yd.	3 in.
580522	190882	Hook #88	Black	25 yd.	5/8 in.
580560	183476	Loop #1000	Black	25 yd.	3 in.

VELCRO®, ONE-WRAP®, VELSTICK® and VELSTRETCH® are registered trademarks of Velcro BVBA. Used with permission.

VELCRO® Brand Hook And Loop Fasteners – Adhesive Back Polyester Tape

A woven tape fastener consisting of two mating strips. The Hook or male section is covered with stiff little hooks. The Loop or female section is covered with tiny soft loops. When pressed together the hooks and loops engage, creating an adjustable, highly versatile and secure closure. Sold in full rolls only.

ITEM #	STYLE #	DESCRIPTION	COLOR	PUT UP	WIDTH
580238	155334	Hook #81	Black	25 yd.	1 in.
580380	192206/155412	Loop #009	White	25 yd.	2 in.
580524	191001/155238	Loop #009	White	25 yd.	1 in.
580525	155553	Hook #81	White	25 yd.	1 in.
580526	191004/155237	Loop #009	Black	25 yd.	1 in.
580527	191254/155474	Hook #81	Black	25 yd.	2 in.
580528	196455/155476	Loop #009	Black	25 yd.	2 in.
580529	191252/155475	Hook #81	White	25 yd.	2 in.

VELCRO®, ONE-WRAP®, VELSTICK® and VELSTRETCH® are registered trademarks of Velcro BVBA. Used with permission.

VELCRO® Brand Hook And Loop Fasteners – Polyester VELCRO®

A woven tape fastener consisting of two mating strips. The Hook or male section is covered with stiff little hooks. The Loop or female section is covered with tiny soft loops. When pressed together the hooks and loops engage, creating an adjustable, highly versatile and secure closure. VELCRO® Brand Hook and Loop fastener tape woven from 100% polyester yarns is resistant to many chemicals and UV light. Sold in full rolls of 25 yards only.

ITEM #	STYLE #	DESCRIPTION	COLOR	PUT UP	WIDTH
580113	192102	Hook #81	Black	25 yd.	1-1/2 in.
580114	192101	Loop #9000	Black	25 yd.	1-1/2 in.

VELCRO®, ONE-WRAP®, VELSTICK® and VELSTRETCH® are registered trademarks of Velcro BVBA. Used with permission.

VELCRO® Brand ONE-WRAP® Fasteners

Self-gripping fasteners, with hook on one side and loop on the other, that will attach to itself easily with solid strength and performance. An ultra-thin solution for many fastening needs, that does not require buckles, snaps, rings or other fastening devices to be added. Available in full rolls only.

ITEM #	STYLE #	COLOR	PUT UP	WIDTH
580403	189590	Black	25 yd.	1 in.
580407	189661	Black	25 yd.	2 in.
580408	189645	Black	25 yd.	3/4 in.
580414	189699	White	25 yd.	2 in.
580437	179917	White	25 yd.	4 in.
580441	189589	Black	25 yd.	5/8 in.
580442	189662	Black	25 yd.	1-1/2 in.

VELCRO®, ONE-WRAP®, VELSTICK® and VELSTRETCH® are registered trademarks of Velcro BVBA. Used with permission.

VELCRO® Brand ONE-WRAP® Fasteners – Flame Retardant

Self-gripping fasteners, with hook on one side and loop on the other, that will attach to itself easily with solid strength and performance. An ultra-thin solution for many fastening needs, that does not require buckles, snaps, rings or other fastening devices to be added. Available in full rolls only.

ITEM #	STYLE #	COLOR	PUT UP	WIDTH
580495	151504	Cranberry/Black	25 yd.	3/4 in.
580496	129914	Cranberry/Black	25 yd.	1 in.

VELCRO®, ONE-WRAP®, VELSTICK® and VELSTRETCH® are registered trademarks of Velcro BVBA. Used with permission.

VELCRO® Brand ONE-WRAP® Cable Tie Straps

Available in full rolls only.

ITEM #	STYLE #	COLOR	SIZE	WIDTH
580404	170075	Black	1 in. x 8 in.	1 in.
580470	161250	Black	1/2 in. x 8 in.	1/2 in.
580471	171681	Black	1/2 in. x 10 in.	1/2 in.
580472	170247	Black	3/4 in. x 5 in.	3/4 in.
580473	170790	Black	3/4 in. x 6 in.	3/4 in.
580474	170091	Black	3/4 in. x 8 in.	3/4 in.
580475	170782	Black	3/4 in. x 12 in.	3/4 in.
580476	170353	Black	1 in. x 12 in.	1 in.

VELCRO®, ONE-WRAP®, VELSTICK® and VELSTRETCH® are registered trademarks of Velcro BVBA. Used with permission.

VELCRO® Brand ONE-WRAP® Cable Tie Straps – Fire Retardant

Available in full rolls only.

ITEM #	STYLE #	COLOR	SIZE	WIDTH
580490	151503	Cranberry/Black	3/4 in. x 8 in.	3/4 in.
580491	129897	Cranberry/Black	3/4 in. x 12 in.	3/4 in.
580492	128528	Cranberry/Black	1 in. x 8 in.	1 in.
580493	129899	Cranberry/Black	1 in. x 12 in.	1 in.

VELCRO®, ONE-WRAP®, VELSTICK® and VELSTRETCH® are registered trademarks of Velcro BVBA. Used with permission.

VELCRO® Brand VELSTRETCH® Hook And Loop Fasteners

This stretch loop is designed to provide about 55% elongation and is a relatively high-power tape. The nylon and synthetic rubber materials used in the construction of this woven product provide moderate to high cycles in use with recommended Hook #65. The plush backing makes this tape ideal for applications where comfort and a secure fit are desired, such as soccer shin guard, and scuba diving equipment straps. Available in full rolls only.

ITEM #	STYLE #	DESCRIPTION	COLOR	PUT UP	WIDTH
580862	195521	Loop #151	Black	40 yd.	2 in.

VELCRO®, ONE-WRAP®, VELSTICK® and VELSTRETCH® are registered trademarks of Velcro BVBA. Used with permission.



VELCRO® Brand VELSTICK® Semi-Rigid Fasteners

A semi-rigid, high impact vinyl extrusion with VELCRO® Brand Hook or Loop Tapes permanently attached. VELSTICK® semi-rigid fasteners were designed and developed for those applications to rigid surfaces where speed and simplicity can be accomplished with the use of staples, tacks, rivets, screws, etc., thus providing a permanent affixation. Designed for easy use, A semi-rigid, high impact vinyl extrusion with VELCRO® Brand hook or loop tapes permanently attached. VELSTICK® semi-rigid fasteners can be cut with scissors, drilled or punched. Ideal for use on tents, camping trailers, stationary and patio awning ties, and all kinds of marine use. Sold in full pieces of 4 feet only.

ITEM #	STYLE #	DESCRIPTION	COLOR	MATERIAL	PUT UP	WIDTH
580112	192657	Hook	Black	Polyester	4 ft.	1 in.
580247	192596	Hook #88	Black	Nylon	4 ft.	1-3/4 in.
580254	192593	Hook #81	White	Polyester	4 ft.	1 in.
580354	192590	Loop #9000 Unnapped	White	Polyester	4 ft.	1 in.
580450	192655	Hook #88	Black	Nylon	4 ft.	1 in.
580452	192653	Loop #1000 Napped	Black	Nylon	4 ft.	1 in.

VELCRO®, ONE-WRAP®, VELSTICK® and VELSTRETCH® are registered trademarks of Velcro BVBA. Used with permission.



Super Seamstick/Hi-Tack Adhesive Tape

Super Seamstick/HiTack is a double-faced, acrylic-based adhesive tape that is ideal for applications where resistance to UV light and excellent performance during temperature extremes are required. Used for bonding and laminating to a wide variety of cloths, vinyls, and rigid and flexible plastics. It's also excellent for seaming Sunbrella® before stitching, and can also be used on stainless steel tubing for patterning with Canvex® pattern cloth. Leaves little or no residue on surfaces when removed.

ITEM #	STYLE #	PUT UP	WIDTH
500422	1 HI-TACK	60 yd.	1 in.
500423	1 1/2 HI-TACK	60 yd.	1-1/2 in.
500432	2263	60 yd.	1/2 in.
500430	2263	60 yd.	1/4 in.
500429	2263	60 yd.	1/8 in.
500428	2 HI-TACK	60 yd.	2 in.
500431	2263	60 yd.	3/8 in.

Sunbrella® is a registered trademark of Glen Raven, Inc. Canvex® is a registered trademark of Raven Industries.

Tape – Vinyl Welding

ITEM #	COLOR	PUT UP	SIZE	WIDTH
500482	Clear	36 yd.	0.016 ga.	3/4 in.



Tape – Vinyl Adhesive Welding

Many products not heat sealable to themselves can now be heat sealed using this tape.

ITEM #	STYLE #	DESCRIPTION	PUT UP	WIDTH
500490	4220	0.005 Adhesive	200 yd.	5/8 in.



Tape – Curtain Strapping

This strapping is used for seam reinforcement or for retention straps for holding rolled up curtains in place. Sold in full rolls only.

ITEM #	DESCRIPTION	COLOR	PUT UP	WIDTH
500433	0.040 gauge	Clear	15 yd.	1-1/2 in.



Tape – Double-Faced

A double-faced adhesive tape used in tacking down layers of fabric prior to sewing a seam.

Rubber Double Faced Tape

High tack tape used when a higher initial tack is required
Can turn slightly yellow
Can be used with acrylic fabrics

Acrylic Double-Faced Tape

Good initial tack
Non-yellowing
High long term adhesion
Very good for all purposes including general sail seaming

ITEM #	STYLE #	MATERIAL	PUT UP	WIDTH
500467	J-351	Rubber	72 yd.	1/4 in.
500469	J-353	Rubber	72 yd.	1/2 in.
500470	J-451	Acrylic	72 yd.	1/4 in.
500471	J-452	Acrylic	72 yd.	3/8 in.
500472	J-453	Acrylic	72 yd.	1/2 in.
500473	J-455	Acrylic	72 yd.	3/4 in.
500474	J-456	Acrylic	72 yd.	1 in.



Tape – Double-Faced Adhesive

Typical applications for this double-faced acrylic foam pressure sensitive tape include body side moldings, rocker trims, and other automotive trim components. The tape is a companion to Costa Track® and is placed in the recess on the bottom of the track for temporary tacking prior to being permanently mounted.

ITEM #	STYLE #	COLOR	PUT UP	WIDTH
500403	#5931N	White	36 yd., 12/box	1/2 in.

Costa Track® is a registered trademark of Costa Marine Canvas and Enclosures, LLC

Tape – Double-Faced Transfer

This clear acrylic tape is used to hold the cut edge of two fabrics together prior to sewing a seam. Eliminates slippage so the seam can be sewn straight.

ITEM #	PUT UP	WIDTH
500435	72 yd.	1/4 in.
500436	72 yd.	1/2 in.
500437	72 yd.	3/4 in.



Tape – No. 463 Seam

To minimize seam leakage on sewn seams of awning fabrics. The 3/4 inch wide tape is for double needle machines. The No. 463 Seam Tape is ideal for use on vinyl laminates such as Weblon®.

The adhesive transfer tape is on a paper backing. The tape should be applied on the edge of the one piece of material to be sewn. The paper backing is then peeled off, leaving the transfer tape on the material. The other piece of material to be sewn is applied on top of the adhesive transfer tape and pressed together. Then the two pieces are ready to be sewn. As the material is being sewn, the up and down movement of the needle pulls the adhesive transfer tape into the needle holes to seal them and thus minimize seam leakage.

ITEM #	STYLE #	PUT UP	WIDTH
500455	463	60 yd., 19/box	2-1/2 in.
500465	463	60 yd., 60/box	5/8 in.
500466	463	60 yd., 48/box	3/4 in.

Weblon® is a registered trademark of Herculite Products Inc.



Tape – Reinforcing

This reinforcement tape is ideal for reinforcing tops, dodgers, enclosures and boat covers. Available in full rolls only.

ITEM #	COLOR	PUT UP	WIDTH
500426	Clear	50 yd.	2 in.



Cord – Corsair Diamond Braid Polyester

The Corsair Polyester Cord features a durable cord with good strength, excellent UV and abrasion resistance, and low elongation.

Item #	Approx. Tensile Strength	Cord Size	Put Up	Size #
507150	360 lbs.	7/64 in.	1000 ft.	3-1/2



Cord – Venetian Blind

Firmly braided cotton cord with small center core.

ITEM #	COLOR	CORD SIZE	PUT UP	SIZE #
515117	Natural	9/64 in.	1500 ft.	4.5



Cord – Cotton Lacing

A braided cotton lacing cord with a high-strength, low-stretch core of filament polyester for superior strength. Can be used for awning line, lacing, drawstrings, hem lines, etc.

ITEM #	APPROX. TENSILE STRENGTH	COLOR	CORD SIZE	PUT UP	SIZE #
507120	300 lbs.	White	7/64 in.	1500 ft.	3-1/2
507121	350 lbs.	White	1/8 in.	1500 ft.	4



Line – Colored Cotton Awning

Manufactured from high strength cotton yarns braided over a low stretch polyester core. A durable lustrous polish combined with popular colors makes this an extremely versatile and popular choice.

ITEM #	COLOR	CORD SIZE	PUT UP	SIZE #
519802	Black	9/64 in.	100 yd.	4.5
519806	Forest Green	9/64 in.	100 yd., 16/box	4.5



Cord – Crown Cotton

A heavy-duty, diamond-braided, cotton-blend cord with a strong synthetic fiber core.

ITEM #	COLOR	CORD SIZE	PUT UP	SIZE #
515118	White	5/32 in.	1000 ft.	5
515119	White	3/16 in.	1000 ft.	6
515120	White	1/4 in.	1000 ft.	8



Line – Ultra Awning

Made with a polyester core for greater strength. This braided line is glazed Grade "A" cotton for longer wearing life.

ITEM #	APPROX. WEIGHT PER TUBE	COLOR	CORD SIZE	PUT UP	SIZE #
507122	10 lbs.	White	9/64 in.	1500 ft.	4.5
507123	12 lbs.	White	5/32 in.	1500 ft.	5
507124	14 lbs.	White	3/16 in.	1500 ft.	6
507125	17 lbs.	White	7/32 in.	1500 ft.	7
507126	26 lbs.	White	1/4 in.	1500 ft.	8

Cord – Diamond Braided Nylon

This diamond braided nylon has high strength, excellent resistance to abrasion and good elasticity under dynamic load. It also works well in wet applications.

ITEM #	APPROX. TENSILE STRENGTH	COLOR	CORD SIZE	PUT UP	SIZE #
518029	450 lbs.	Black	1/8 in.	1000 ft.	4
518030	775 lbs.	White	3/16 in.	1000 ft.	6



Line – Ultra Mason

A braided cord made of high quality cotton to assure uniform size and quality. Excellent small diameter cord for lacing windbreaks, stationaries and store awnings. Also used for drawstrings.

ITEM #	COLOR	CORD SIZE	PUT UP	SIZE #
507130	White	7/64 in.	3000 ft.	3.5

Cord – Premium Sash

Cotton cover, synthetic core. General, all purpose cotton sash cord used for home, recreation and industrial jobs.

ITEM #	APPROX. TENSILE STRENGTH	CORD SIZE	PUT UP	SIZE #
506592	800 lbs.	1/4 in.	1000 ft.	8



Rope – Diamond Braided Polyester

Polyester cord with high strength and excellent abrasion resistance. This cord has very good UV resistance. Resists acids, alkalis and moisture.

ITEM #	CORD SIZE	PUT UP	SIZE #
518606	1/8 in.	1000 ft.	4

Rope – Supreme MFP Braided

Multifilament solid braided polypropylene with abrasion-resistant smooth finish. Good strength with low stretch and excellent dielectric qualities. Resistant to rot, mildew, oil and most chemicals. This rope also floats.

ITEM #	APPROX. TENSILE STRENGTH	COLOR	CORD SIZE	PUT UP	SIZE #
515517	305 lbs.	White	3/16 in.	1000 ft.	6
515518	530 lbs.	White	1/4 in.	1000 ft.	8



Rope – Yukon Braided Cotton

Quality glazed cotton over a synthetic core. Used mainly for awning cords. Yukon Braided Cotton Rope is easy to knot with more strength than an all-cotton product.

ITEM #	CORD SIZE	PUT UP	SIZE #
507138	9/64 in.	500 yd.	4.5
507139	5/32 in.	500 yd.	5
507140	3/16 in.	500 yd.	6
507141	7/32 in.	500 yd.	7
507142	1/4 in.	500 yd.	8



Cord – Diamond Braided MFP

Suggested uses include drawstrings, lacing cords, general utility.

ITEM #	APPROX. TENSILE STRENGTH	COLOR	CORD SIZE	PUT UP	SIZE #
515449	250 lbs.	Black	1/8 in.	1000 ft.	4
515450	250 lbs.	Black	1/8 in.	3000 ft.	4

Cord – Diamond Braided Nylon Utility

Suggested uses include drawstrings, lacing cords, general utility.

ITEM #	APPROX. TENSILE STRENGTH	COLOR	CORD SIZE	PUT UP	SIZE #
515084	490 lbs.	White	1/8 in.	3000 ft.	4



Cord – Drawtite Cotton

Braided fine cotton with low stretch synthetic cord. Glazed cover. Used for cotton awning lacing and window furnishings.

ITEM #	CORD SIZE	PUT UP	SIZE #
507145	7/64 in.	500 yd.	3-1/2
507146	1/8 in.	1000 yd.	4
507149	7/64 in.	1000 yd.	3-1/2



Cord – Hollow Braided Polypropylene

A low-cost, diamond-braided cord. This cord is hollow – there is no filler core. Suggested for use as barrier rope, tie-down, general marine and hardware uses.

ITEM #	COLOR	CORD SIZE	PUT UP	SIZE #
519148	Black	1/4 in.	1000 ft.	8
519136	White	5/16 in.	1000 ft.	10
519134	White	3/16 in.	1000 ft.	6
519135	White	1/4 in.	1000 ft.	8
519132	Yellow	5/16 in.	1000 ft.	10
519131	Yellow	1/4 in.	1000 ft.	8



Cord – MFP Solid Braided Polypropylene

Made of white multifilament polypropylene. Resists acids, alkalis and mildew. Floats in and does not absorb water. Ends can be fused to prevent fraying. Versatile for many marine applications.

ITEM #	APPROX. TENSILE STRENGTH	CORD SIZE	PUT UP	SIZE #
515452	505 lbs.	3/16 in.	1000 ft.	6
515454	750 lbs.	1/4 in.	1000 ft.	8
515456	1250 lbs.	5/16 in.	1000 ft.	10



Cord – Neobraid® Polyester

100% high-strength polyester cord excels in awning applications and is a superb all-purpose/industrial cord. Patented InterWarp® construction withstands years of weather and sun, and does not kink, twist, or fray. Resistant to mold, oil and stains.

ITEM #	APPROX. TENSILE STRENGTH	COLOR	CORD SIZE	PUT UP	SIZE #
519941	300 lbs.	Black	7/64 in.	1000 ft.	3-1/2
519945	350 lbs.	Black	1/8 in.	1000 ft.	4
519952	410 lbs.	Black	9/64 in.	3000 ft.	4-1/2
519950	469 lbs.	Black	5/32 in.	1000 ft.	5
519948	700 lbs.	Black	3/16 in.	1000 ft.	6
519947	1000 lbs.	Black	1/4 in.	1000 ft.	8
519971	350 lbs.	Burgundy	1/8 in.	1000 ft.	4
519933	350 lbs.	Charcoal Gray	1/8 in.	500 ft.	4
519972	350 lbs.	Forest Green	1/8 in.	1000 ft.	4
519932	350 lbs.	Forest Green	1/8 in.	500 ft.	4
519939	1600 lbs.	White	5/16 in.	500 ft.	10
519944	350 lbs.	White	1/8 in.	1000 ft.	4
519930	350 lbs.	White	1/8 in.	500 ft.	4
519946	406 lbs.	White	9/64 in.	1000 ft.	4-1/2
519951	410 lbs.	White	9/64 in.	3000 ft.	4-1/2
519949	700 lbs.	White	3/16 in.	1000 ft.	6
519953	700 lbs.	White	3/16 in.	3000 ft.	6
519936	700 lbs.	White	3/16 in.	500 ft.	6
519938	1000 lbs.	White	1/4 in.	500 ft.	8

Neobraid Warning: Not For Personal Safety. Working loads are for rope in good condition with appropriate splices, in non-critical applications and under normal service conditions. Do not exceed working loads without expert knowledge of conditions and professional estimates of risk. Working loads should be reduced where life, limb and valuable property are involved or with shock loads, sustained loads. Never stand in line with rope under tension or directly underneath rope under tension.

Neobraid® and InterWarp® are registered trademarks of New England Overseas Corporation.



Cord – Neoline® Polyester

100% polyester jacket and polyester/polypropylene core offers superior strength and abrasion resistance. Ideal for awnings and everyday use. Patented InterWarp® construction knots well, is weather resistant, and is twist and fray free.

ITEM #	APPROX. TENSILE STRENGTH	COLOR	CORD SIZE	PUT UP	SIZE #
519911	220 lbs.	Black	1/8 in.	1000 ft.	4
519960	460 lbs.	Black	3/16 in.	1000 ft.	6
519907	460 lbs.	Light Beige	3/16 in.	1000 ft.	6
519922	185 lbs.	White	7/64 in.	3000 ft.	3-1/2
519912	220 lbs.	White	1/8 in.	1000 ft.	4
519923	220 lbs.	White	1/8 in.	3000 ft.	4
519904	220 lbs.	White	1/8 in.	500 ft.	4
519913	307 lbs.	White	9/64 in.	1000 ft.	4-1/2
519924	307 lbs.	White	9/64 in.	3000 ft.	4-1/2
519915	370 lbs.	White	5/32 in.	1000 ft.	5
519916	460 lbs.	White	3/16 in.	1000 ft.	6
519926	460 lbs.	White	3/16 in.	3000 ft.	6
519906	460 lbs.	White	3/16 in.	500 ft.	6
519917	750 lbs.	White	7/32 in.	1000 ft.	7
519918	750 lbs.	White	1/4 in.	1000 ft.	8
519908	750 lbs.	White	1/4 in.	500 ft.	8

Neoline Warning: Not For Personal Safety. Working loads are for rope in good condition with appropriate splices, in non-critical applications and under normal service conditions. Do not exceed working loads without expert knowledge of conditions and professional estimates of risk. Working loads should be reduced where life, limb and valuable property are involved or with shock loads, sustained loads. Never stand in line with rope under tension or directly underneath rope under tension.

Neoline® and InterWarp® are registered trademarks of New England Overseas Corporation.



Cord – Solid Braided Polyester

Braided of clean, high tensile strength polyester. Resists acids, alkalis and moisture. Ends can be fused to prevent fraying. Ideal for drawstrings and in hems of synthetic tarpaulins. Popular for boating and awning line.

ITEM #	APPROX. TENSILE STRENGTH	COLOR	CORD SIZE	PUT UP	SIZE #
515357	1600 lbs.		5/16 in.	1000 ft.	10
515358	2175 lbs.		3/8 in.	1000 ft.	12
515350	200 lbs.		3/32 in.	1000 ft.	3
515351	310 lbs.		1/8 in.	1000 ft.	4
515339	310 lbs.	White	1/8 in.	500 ft.	4
515352	425 lbs.		5/32 in.	1000 ft.	5
515353	620 lbs.		3/16 in.	1000 ft.	6
515342	620 lbs.		3/16 in.	500 ft.	6
518602	750 lbs.		3/16 in.	1000 ft.	6
515381	900 lbs.		3/16 in.	1000 ft.	6
515355	1050 lbs.		1/4 in.	1000 ft.	8
515344	1050 lbs.		1/4 in.	500 ft.	8



Cord – Nylon

Cord features good abrasion resistance.

ITEM #	APPROX. TENSILE STRENGTH	COLOR	CORD SIZE	PUT UP	SIZE #
518032	750 lbs.	White	1/8 in.	3000 ft.	4



Cord – Twisted S.F.T. Polypropylene

Made from fibrillated (shattered film type) or interconnected filaments. Recommended workload is 17% of breaking strength. Floats in, but does not absorb water. Very good resistance to most acids and alkalis.

ITEM #	APPROX. TENSILE STRENGTH	COLOR	CORD SIZE	PUT UP	SIZE #
515221	1130 lbs.	White	1/4 in.	1200 ft.	8



Cord – Solid Braided Nylon

This is one of the finest quality and best performing nylon solid braided cords. Designed for marine and industrial use, the product is constructed from high tenacity 12 strand interlocking nylon fibers, and has excellent shock load absorption qualities.

ITEM #	APPROX. TENSILE STRENGTH	COLOR	CORD SIZE	PUT UP	SIZE #
515432	450 lbs.	White	1/8 in.	1000 ft.	4
515433	750 lbs.	White	3/16 in.	1000 ft.	6
515434	1200 lbs.	White	1/4 in.	1000 ft.	8



Cord – Saxon Nylon

Industrial-grade multifilament nylon. A strong, premium product that works well with pulleys.

ITEM #	COLOR	CORD SIZE	PUT UP	SIZE #
515250	Natural	1/8 in.	1000 ft.	4
515251	Natural	3/16 in.	1000 ft.	6
515252	Natural	1/4 in.	1000 ft.	8

Rope – 3-Strand Polypropylene

Filament polypropylene rope with excellent strength to weight ratio. Will float because specific gravity is less than 1.0. Hand and lay is medium/soft, which makes this product easy to splice.

ITEM #	APPROX. TENSILE STRENGTH	COLOR	CORD SIZE	PUT UP	SIZE #
516259	2430 lbs.	Black	3/8 in.	1200 ft.	
516254	3780 lbs.	White	1/2 in.	1200 ft.	
516252	3780 lbs.	White	1/2 in.	600 ft.	
516242	1130 lbs.	White	1/4 in.	1200 ft.	8
516240	1130 lbs.	White	1/4 in.	600 ft.	8
516238	720 lbs.	White	3/16 in.	1200 ft.	6
516236	720 lbs.	White	3/16 in.	600 ft.	6
516258	7650 lbs.	White	3/4 in.	600 ft.	
516250	2430 lbs.	White	3/8 in.	1200 ft.	
516248	2430 lbs.	White	3/8 in.	600 ft.	
516246	1710 lbs.	White	5/16 in.	1200 ft.	10
516256	5580 lbs.	White	5/8 in.	600 ft.	
516222	3780 lbs.	Yellow	1/2 in.	1200 ft.	
516220	3780 lbs.	Yellow	1/2 in.	600 ft.	
516206	1130 lbs.	Yellow	1/4 in.	1200 ft.	8
516202	720 lbs.	Yellow	3/16 in.	1200 ft.	6
516200	720 lbs.	Yellow	3/16 in.	600 ft.	6
516226	7650 lbs.	Yellow	3/4 in.	600 ft.	
516214	2430 lbs.	Yellow	3/8 in.	1200 ft.	
516210	1710 lbs.	Yellow	5/16 in.	1200 ft.	
516208	1710 lbs.	Yellow	5/16 in.	600 ft.	10
516224	5580 lbs.	Yellow	5/8 in.	600 ft.	
516274	1130 lbs.	Yellow/Black	1/4 in.	600 ft.	8



Rope – Zenith

Polyester cord with high strength and excellent abrasion resistance. This cord also has a very good UV resistance and resists acids, alkalis and moisture.

ITEM #	DESCRIPTION	APPROX. TENSILE STRENGTH	COLOR	CORD SIZE	PUT UP	SIZE
519223	Bonded	400 lbs.	White	1/8 in.	1500 ft.	4
519224	Bonded	400 lbs.	Black	1/8 in.	1500 ft.	4



Rope – Unmanila™ Polypropylene

This rope has a simulated manila look with performance durability of polyolefin. It is a fibrillated film fiber that has balanced construction, medium lay and moderate strength/moderate stretch. It is lightweight and buoyant, and exhibits good abrasion resistance and excellent hand and knotability.

ITEM #	COLOR	CORD SIZE	PUT UP	SIZE #
515218	Tan	1/4 in.	1200 ft.	8

Unmanila™ is a trademark of Wellington Puritan Mills, Inc.



Twine – Polypro

Made from 100% fibrillated film polypropylene. An economical twine that holds knots well and is stronger than all natural fiber twines. Some sizes available in plied construction. Ideal for general tying and attaching advertising banners.

ITEM #	DESCRIPTION	CORD SIZE	PUT UP	SIZE #
515220	3-Ply (PRT NWT 20CT-SW Bulk)	3/16 in.	10 lb. coreless tube (2800 ft.)	850
515222	1-Ply	3/32 in.	10 lb. coreless tube (5500 ft.)	550



Cord – Nylon Shock

Nylon covered elastic cord of synthetic rubber. Single cover. Ideal for sewing in boat cover hems, lacing down boat covers, car luggage racks and fastening applications. Sold in full rolls only.

ITEM #	STYLE #	DESCRIPTION	COLOR	CORD SIZE	PUT UP
506326				1/4 in.	150 ft.
506334				1/4 in.	500 ft.
506317	16448		Black	1/8 in.	300 ft.
506324				1/8 in.	300 ft.
506325				3/16 in.	150 ft.
506318	16930N		Beige	3/16 in.	500 ft.
506328				3/8 in.	100 ft.
506329		Double Cover		3/8 in.	100 ft.
506327				5/16 in.	150 ft.



Cord – Single Cover Elastic

Elastic cord of synthetic rubber, designed to remain flexible and offer dependable elasticity when needed. When using any shock cords, always make sure ends are properly secured.

ITEM #	STYLE #	DESCRIPTION	COLOR	CORD SIZE	PUT UP	SIZE #
506486	5	Cotton Covered		1/2 in.	100 ft.	
506458	121	Cotton Covered		1/4 in.	150 ft.	8
506455	130	Cotton Covered		1/8 in.	300 ft.	4
506456	1122	Cotton Covered		3/16 in.	150 ft.	6
506484	MILC 5651 T-3	Cotton Covered		3/16 in.	500 ft.	6
506462	350	Cotton Covered		3/8 in.	100 ft.	
506460	312	Cotton Covered		5/16 in.	100 ft.	10
506350	M-4	Polypropylene Covered		1/4 in.	150 ft.	
506357	M-4	Polypropylene Covered	Black	1/4 in.	300 ft.	
506355	M-4	Polypropylene Covered	Black	1/4 in.	500 ft.	
506340	M-3	Polypropylene Covered		3/16 in.	1000 ft.	
506348	M-3 Black	Polypropylene Covered	Black	3/16 in.	300 ft.	
506363		Polypropylene Covered	White	3/16 in.	100 ft.	
506349	M-3	Polypropylene Covered	White	3/16 in.	300 ft.	
506354	M-6	Polypropylene Covered		3/8 in.	100 ft.	
506352	M-5	Polypropylene Covered		5/16 in.	150 ft.	
506356	M-5	Polypropylene Covered	Black	5/16 in.	150 ft.	
506359	4002	Polypropylene Covered		7/16 in.	250 ft.	

Warning: Secure hooks to ends carefully. Do not overstretch cord more than 50% of its normal length. Sudden disconnect in a stretched position may cause serious injury. Keep face and other vulnerable parts of the body away from the rebound path of the cord. Wear Safety Glasses during tie down and disconnect. Inspect cord before use. Discard if abraded, cut or cracked. Do not use to hold any surface which reacts to wind or air movement.



Cord – Synthetic Shock

ITEM #	COLOR	CORD SIZE	PUT UP
506489	White	1/8 in.	500 ft.
506490	White	3/16 in.	300 ft.
506491	White	1/4 in.	300 ft.
506492	White	5/16 in.	300 ft.
506493	White	3/8 in.	150 ft.
506494	White	1/2 in.	100 ft.
506497	Black	1/8 in.	500 ft.



Cord – Cone Spring Hooks

Stainless steel. Used for fastening ends of elastic cords.

ITEM #	STYLE #	CORD SIZE	PUT UP
506166	3	3/16 in.	100
506167	4	1/4 in.	100
506168	5	5/16 in.	100
506169	6	3/8 in.	100



Cord – Hog Ring Pliers

Fits 1/8 inch, 3/16 inch, 1/4 inch, 5 /16 inch and 3/8 inch sizes of loop and end clamps.

ITEM #	STYLE #	DESCRIPTION
506150	1440AO	Opening Spring
506151	1440AC	Closing Spring



Cord – Loop And End Clamps

302 stainless steel. All looping rings are applied with clamp pliers. Used for splicing elastic cord.

ITEM #	STYLE #	CORD SIZE	PUT UP
506161	X-0	1/4 in.	100
506155	X-0	1/4 in.	620
506160	X-00	1/8 and 3/16 in.	100
506156	X-00	1/8 and 3/16 in.	736
506162	X-1	5/16 in.	100
506158	X-1	5/16 in.	515
506163	X-2	3/8 in.	100



Cord – Plier Clamp

ITEM #	STYLE #
506152	XX

REFERENCE

STANDARD AWNING AND MARINE STYLES	320
CALCULATIONS AND MEASUREMENTS	321
YARDAGE GUIDE AND CUTTING TABLE	324
INDEX	326
TERMS OF SALE	335
NOTES	337
CREDIT APPLICATION	

Standard Awning Styles

(Courtesy of Professional Awning Manufacturers Association (PAMA), a division of the Industrial Fabrics Association International)

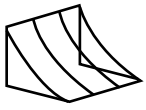

Concave



Dome

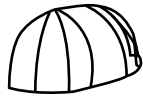

Elongated Dome



Lateral Arm/
Retractable



Quarter Round/Convex

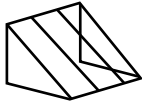

Traditional



Rounded Entrance Canopy

Standard Marine Styles

(Courtesy of The Marine Fabricators Association)

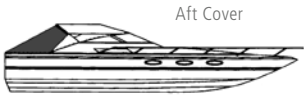

Aft Cover

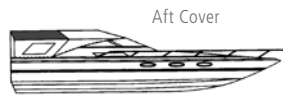

Aft Cover

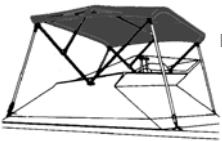

Bimini Top



Dodgers

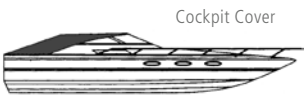

Cockpit Cover

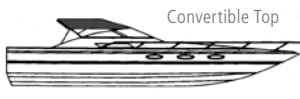

Convertible Top

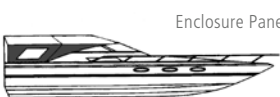

Enclosure Panel

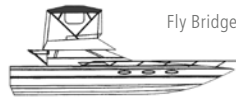

Fly Bridge Bimini

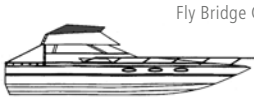

Fly Bridge Cover

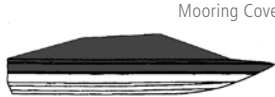

Mooring Cover

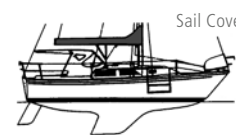

Sail Cover



Windshield Cover

Conversion Chart

A Yd. of Material this Wide in In.	B Contains this Many Sq. Ft.	C Contains this Many Sq. Yds.
31	7.75	0.86
36	9.00	1.00
40	10.00	1.11
46	11.50	1.28
47	11.75	1.31
48	12.00	1.33
54	13.50	1.50
60	15.00	1.67
61	15.25	1.69
62	15.50	1.72
72	18.00	2.00
76	19.00	2.11
78	19.50	2.17
80	20.00	2.22
84	21.00	2.33
96	24.00	2.67
108	27.00	3.00

To compute the cost per sq. ft. or sq. yd., simply take the price of the goods per linear yd. and divide it by the factor in column B or C.

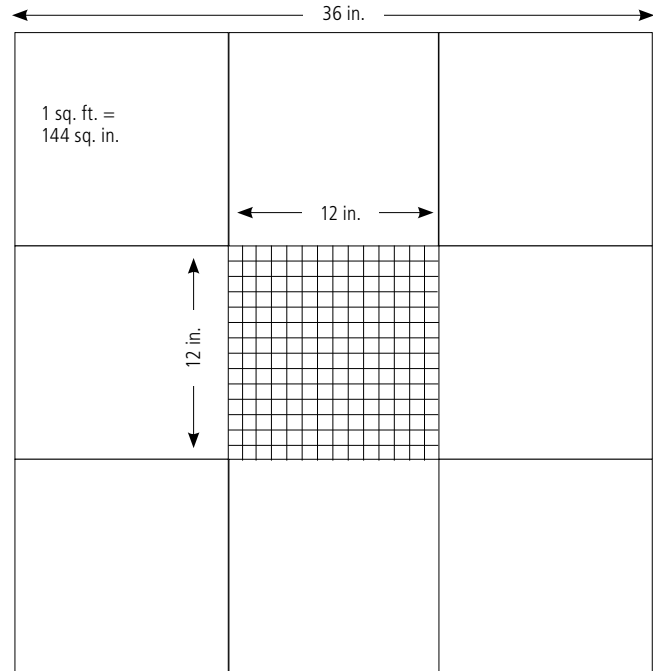

Handy Tips to Know

- There are 144 sq. in. per sq. ft.
- There are 9 sq. ft. per sq. yd.
- There are 1296 sq. in. per sq. yd.

Handy Tips to Know

- 1 sq. yd. = 9 sq. ft.
- 1 sq. yd. = 1296 sq. in.

Common Cloth Calculations

To Find Pro Rata Price

(Knowing the price per yd. of a given width of cloth, what would be the pro rata price of the same cloth woven in another width?)

Example: If 46 in. cloth is priced at \$7.00 per yd., what would the pro rata price be in the same cloth woven 60 in. wide?

Formula:

$$\frac{\text{Known Width}}{\text{Known Price}} = \frac{\text{Desired Width}}{\text{Desired Price}}$$

Or

$$\frac{46}{\$7.00} = \frac{60}{x} : \frac{60 \times \$7.00}{46} = x : \frac{420}{46} = x = \$9.13$$

To Find Pro Rata Wt. Expressed in Oz. per Linear Yd.

(Knowing the width and oz. per linear yd. of a given cloth, what would be the wt. of the same cloth woven in another width?)

Example: What is the pro rata wt. of 36 in. 12 oz. S.F. Duck woven 44 in. wide?

Formula:

$$\frac{\text{Known Width}}{\text{Known Price}} = \frac{\text{Desired Width}}{\text{Desired Price}}$$

Or

$$\frac{36}{12} = \frac{44}{x} : \frac{12 \times 44}{36} = x : \frac{528}{36} = x = \$14.67$$

To Find Pro Rata Wt. Expressed in Yds. per Lb.

(Knowing the width and linear yds. per lb. of a given cloth, what would be the wt. of the same cloth woven in another width?)

Example: What is the pro rata wt. of 36 in. 6.15 yd. sheeting woven 45 in. wide?

Formula:

$$\frac{\text{Known Width} \times \text{Known Weight}}{\text{Desired Width}} = \text{Desired Weight}$$

Or

$$\frac{36 \times 6.15}{45} = x : \frac{221.4}{45} = x = 4.92 \text{ yd.}$$

To Find the Oz. Wt. per Linear Yd. of Number Ducks

(Knowing the number designation of a wide duck, what does it weigh in oz.?)

Example: What is the linear yd. oz. wt. of 22 in. No. 4 Duck?

Formula: 19 less the number of the Duck equals its oz. wt. in 22 in. width or: $19 - 4 = 15$ oz.

The rule-of-thumb formula holds true for all numbers of Duck, 1 through 12 inclusive. To figure 22 in. oz. wt. for Number Ducks, to 19 add one less than number. Example: 22 in. No. 7/0 wts. 25 oz. or 19 plus 6.

Having established the 22 in. oz. wt. of a number Duck, the linear yd. wt. of any other width can be determined by a pro rata calculation.

Conversion of Yds. per Lb. to Oz. per Yd.

(Knowing the wt. of a given cloth in yd. per lb., what is the wt. expressed in oz. per yd.?)

Example: What is the wt. of oz. per yd. of 37 in. 2.75 yd. drill?

Formula:

$$\frac{16 \text{ oz. (1 lb.)}}{\text{yds. per lb.}} = \text{oz. per yd.}$$

Or

$$\frac{16}{2.75} = 5.818 \text{ oz.}$$

Conversion of Oz. per Yd. to Yds. per Lb.

(Knowing the wt. of a given cloth in oz. per yd., what is the wt. expressed in yds. per lb.?)

Example: What is the wt. in yds. per lb. of 36 in. 10 oz. S.F.?

Formula:

$$\frac{16 \text{ oz. (1 lb.)}}{\text{oz. per lb.}} = \text{yds. per lb.}$$

Or

$$\frac{16}{10} = 1.6 \text{ yd. per lb.}$$

(From "Swirles on Basic Fabrics" copyright 1957)

Mathematical Aids

To determine the cost of covering any flat surface, first compute its area in square measure. You can compute the area of almost any shape by using the following formulas. For odd shaped areas, it may be necessary to combine several of these formulas.

A = Area
SA = Surface Area
C = Circumference

CIRCLE
 $A = \pi r^2$
 $A = 3.1416 \times 5 \times 5$
 $A = 78.54$

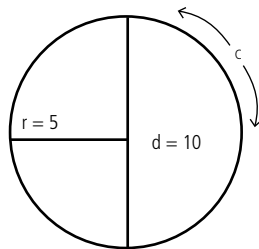

Note:
 $d = 2r$
 $c = \pi d$
 $c = 3.1416 \times 10$
 $c = 31.416$

SPHERE
 $SA = \pi d^2$
 $SA = 3.1416 \times 7 \times 7$
 $SA = 153.94$

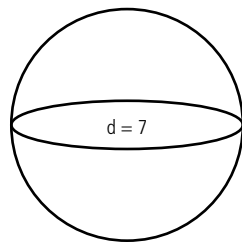

RECTANGLE
 $A = l \times w$
 $A = 8 \times 4$
 $A = 32$

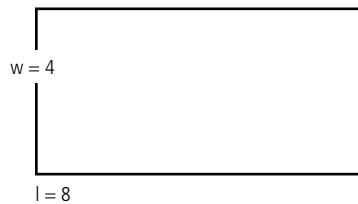

TRIANGLE
 $A = (b \times h) / 2$
 $A = (4 \times 4) / 2$
 $A = 8$

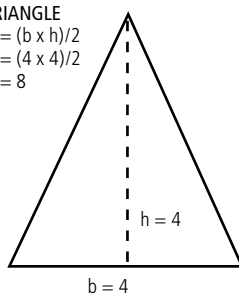

4-SIDED PYRAMID
 $SA = 2bh + b^2$
 $SA = (2 \times 2 \times 4) + (2 \times 2)$
 $SA = 20$

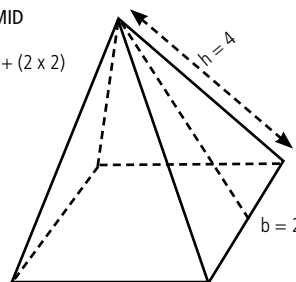

CYLINDER
 $SA = 2\pi r^2 + 2\pi rh$
 $SA = (2 \times 3.1416 \times 3 \times 3) + (2 \times 3.1416 \times 3 \times 5)$
 $SA = 56.55 + 94.25$
 $SA = 150.8$

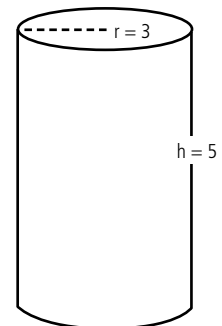

PYTHAGOREAN THEOREM
 $c^2 = a^2 + b^2$
 $c^2 = (3 \times 3) + (4 \times 4)$
 $c^2 = 25$
 $c = 5$

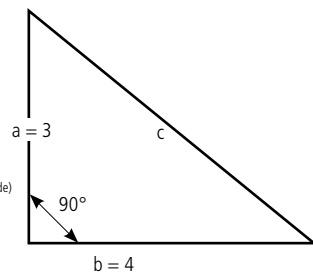

In a right triangle, the square of the hypotenuse (the longest side) is equal to the sum of the squares of the other two sides.

Linear Measure

English	Metric
12 in. = 1 ft.	10 mm = 1 cm
3 ft. = 1 yd.	100 cm = 1 m
36 in. = 1 yd.	1000 mm = 1 m

English/Metric Equivalents

English	Metric
1 in. = 25.4 mm	1 mm = .0397 in.
1 in. = 2.54 cm	1 cm = .3937 in.
1 in. = .0254 m	1 m = 39.37 in.
1 yd. = .9144 m	1 m = 1.0936 yd.

Square Measure

English	Metric
144 sq. in. = 1 sq. ft.	100 sq. mm = 1 sq. cm
9 sq. ft. = 1 sq. yd.	10,000 sq. cm = 1 sq. m
1296 sq. in. = 1 sq. yd.	1,000,000 sq. mm = 1 sq. m

English/Metric Equivalents

1 sq. yd. = .836 sq. m	1 sq. m = 1.196 sq. yd.
1 sq. in. = .0006451 sq. m	1 sq. m = 1550 sq. in.

Decimal Equivalents

$1/16 = .0625$	$9/16 = .5625$
$1/8 = .1250$	$5/8 = .6250$
$3/16 = .1875$	$11/16 = .6875$
$1/4 = .2500$	$3/4 = .7500$
$5/16 = .3125$	$13/16 = .8125$
$3/8 = .3750$	$7/8 = .8750$
$7/16 = .4375$	$15/16 = .9375$
$1/2 = .5000$	

RECTANGULAR PRISM
 $SA = 2(lw + hl + hw)$
 $SA = 2 \times [(6 \times 3) + (2 \times 6) + (2 \times 3)]$
 $SA = 72$

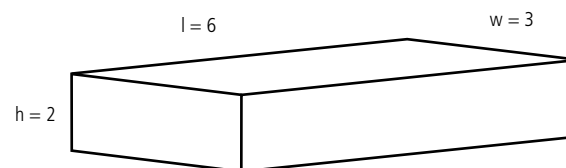

Yardage Guide

Yardage of Residence Window Awnings 31 in. Material

Sum of Ht. and Projection	Width of Awning												Deduct for Each End Not Req'd.		
	2	2-6	3	3-6	4	4-6	5	6	7	8	9	10		11	12
3-0	3	3	3	3	4	4	4	5	5	6	6	7	7	8	1/4
3-6	3	3	4	4	4	5	5	5	6	6	7	7	8	8	1/4
4-0	3	3	4	4	5	5	5	6	6	7	8	8	9	9	1/4
4-6	4	4	4	4	5	5	5	6	6	7	8	8	9	10	1
5-0	4	4	5	5	6	6	6	7	8	8	9	10	10	11	1
5-6	4	4	5	5	6	6	6	7	8	9	10	10	11	11	1
6-0	5	5	5	6	6	7	7	8	9	10	11	11	12	12	1
6-6	6	6	6	7	7	8	8	9	10	11	12	13	13	14	1 1/2
7-0	6	6	7	8	8	9	9	10	11	12	13	14	15	15	2
7-6	7	7	8	9	9	10	10	11	12	13	14	15	16	17	2
8-0	8	8	8	9	9	10	10	11	12	14	15	16	17	18	2 1/2
8-6	9	9	9	10	10	10	11	12	13	14	15	16	18	19	2 1/2
9-0	9	9	10	10	11	11	12	13	14	15	16	17	19	20	3
9-6	10	10	11	11	12	12	13	14	15	16	18	19	20	21	3
10-0	10	10	11	12	12	13	14	15	16	17	18	20	21	22	3
10-6	11	11	12	13	14	15	16	17	18	19	21	22	23	24	3 1/2
11-0	12	12	13	13	14	15	16	17	18	19	20	22	23	24	4
11-6	13	13	13	14	15	16	17	18	19	20	22	23	24	25	4
12-0	13	13	14	14	15	16	17	18	20	21	23	24	25	26	4 1/2

Yardage of Residence Window Awnings 46 in. Material

Sum of Ht. and Projection	Width of Awning												Deduct for Each End Not Req'd.		
	2	2-6	3	3-6	4	4-6	5	6	7	8	9	10		11	12
3-0	2	2	2	2	3	3	3	3	3	4	4	4	4	5	1/2
3-6	2	2	3	3	3	3	4	4	4	4	4	5	5	5	1/2
4-0	3	3	3	3	4	4	4	4	4	6	6	6	6	7	3/4
4-6	4	4	4	4	5	5	5	5	5	7	7	7	7	8	3/4
5-0	4	4	4	4	6	6	6	6	6	8	8	8	8	10	1
5-6	4	5	5	5	7	7	7	7	7	9	9	9	9	10	1
6-0	5	5	5	5	7	7	7	7	7	9	9	9	9	11	1 1/4
6-6	5	5	5	5	8	8	8	8	8	10	10	10	10	12	1 1/2
7-0	6	6	6	6	8	8	8	8	8	10	10	10	10	12	1 1/2
7-6	6	6	6	6	9	9	9	9	9	11	11	11	11	13	1 3/4
8-0	6	7	7	7	9	9	9	9	9	12	12	12	12	14	2
8-6	7	7	7	7	9	9	9	9	9	12	12	12	12	14	2
9-0	7	7	7	7	10	10	10	10	10	12	12	12	12	15	2
9-6	7	7	7	7	10	10	10	10	10	13	13	13	13	15	2
10-0	7	8	8	8	11	11	11	11	11	11	13	13	13	16	2 1/4
10-6	8	8	8	8	11	11	11	11	11	11	14	14	14	17	2 1/2
11-0	8	8	8	8	11	11	11	11	11	15	15	15	15	18	2 1/2
11-6	9	9	9	9	12	12	12	12	12	15	15	15	15	18	2 1/2
12-0	9	9	9	9	12	12	12	12	12	16	16	16	16	19	2 1/2

Yardage of Stationary Awnings – 31 in.

Sum of Ht. and Projection	Width of Awning																				Deduct for Each End Not Req'd.									
	12'3	13'3	14'3	15'3	16'3	17'3	18'3	19'3	20'3	21'3	22'3	23'3	24'3	25'3	26'3	27'3	28'3	29'3	30'3	31'3		32'3	33'3	34'3	35'3	36'3	37'3	38'3	39'3	40'3
10'2"	28	30	32	33	35	36	38	40	42	44	44	47	48	50	50	53	55	57	58	59	60	61	63	64	65	66	68	69	70	3
11'2"	31	33	34	36	37	39	41	43	45	46	47	49	51	52	54	56	57	59	60	61	63	64	66	67	69	70	72	73	75	3 1/2
12'2"	33	35	37	39	40	42	44	46	48	49	51	53	55	56	57	59	61	63	65	66	68	70	72	73	75	77	79	80	82	4 1/2
13'2"	36	38	40	41	43	45	47	49	52	53	55	57	59	60	62	64	66	68	70	72	74	76	78	79	81	83	85	86	88	5 1/2
14'2"	38	40	42	44	46	48	51	53	56	58	59	61	63	65	66	68	70	72	75	77	79	81	83	85	87	89	90	92	94	6 1/2
15'2"	41	43	46	48	50	52	55	57	59	61	63	66	68	69	71	73	75	77	79	81	84	86	88	90	92	95	96	98	100	7
16'2"	43	45	48	50	52	55	57	60	62	64	66	69	71	73	75	77	80	82	85	88	90	93	95	97	100	102	104	106	108	7 1/2
17'2"	46	50	53	55	57	59	62	65	67	69	71	73	75	77	79	81	84	86	89	92	95	98	100	103	105	107	110	112	114	8
18'2"	49	53	56	59	61	64	66	68	70	74	77	81	83	86	89	92	95	98	100	103	105	107	110	113	115	118	120	123	126	8 1/2
19'2"	53	56	60	62	65	68	72	75	79	82	85	88	91	94	97	100	104	107	110	112	116	119	121	124	127	130	133	137	140	9
20'2"	56	56	63	66	69	72	75	79	82	85	88	92	95	98	100	103	106	109	112	115	118	121	124	126	129	132	135	139	143	10

Note: All yardages have been rounded off to the next higher whole number. Also, no allowance for waste figured in above.

Yardage of Stationary Awnings – 46 in.

Sum of Ht. and Projection	Width of Awning																				Deduct for Each End Not Req'd.									
	12'3	13'3	14'3	15'3	16'3	17'3	18'3	19'3	20'3	21'3	22'3	23'3	24'3	25'3	26'3	27'3	28'3	29'3	30'3	31'3		32'3	33'3	34'3	35'3	36'3	37'3	38'3	39'3	40'3
10'2"	20	20	22	24	24	25	26	27	28	30	31	32	34	36	36	37	38	39	39	40	40	41	41	42	42	43	44	45	46	2
11'2"	22	22	23	26	27	28	31	32	33	36	37	38	39	40	41	42	43	45	46	47	48	50	50	51	52	54	54	55	57	2
12'2"	24	26	27	29	31	32	34	35	37	39	40	41	42	44	45	46	47	49	50	51	52	54	55	56	57	59	60	61	62	2 1/2
13'2"	26	27	29	31	32	34	36	37	38	39	42	43	44	46	47	48	49	51	52	53	54	56	57	58	59	61	62	63	64	3
14'2"	28	28	30	33	33	35	36	38	38	43	44	45	46	48	49	50	51	53	54	55	56	58	59	60	61	63	64	65	67	3 1/2
15'2"	30	30	32	35	35	38	40	42	43	45	46	47	48	50	51	52	53	55	56	57	58	60	61	62	63	65	66	67	69	3 1/2
16'2"	32	32	34	38	38	41	44	46	48	50	51	53	54	56	57	58	60	62	63	64	66	68	69	70	72	74	75	76	78	4
17'2"	35	35	38	41	43	45	47	49	51	53	55	56	57	59	61	62	63	65	67	68	69	70	73	74	75	77	78	79	80	4 1/2
18'2"	37	39	41	43	45	47	49	51	53	55	57	58	60	62	64	65	66	68	70	71	72	74	76	77	78	80	81	82	84	5
19'2"	39	41	43	45	46	49	52	54	56	58	60	61	63	65	67	68	69	71	73	74	75	78	80	82	83	84	85	86	87	5 1/2
20'2"	41	43	46	48	50	52	55	57	59	62	64	66	67	69	71	73	74	76	78	79	81	83	85	87	88	90	91	92	93	6

Note: All yardages have been rounded off to the next higher whole number. Also, no allowance for waste figured in above.

Yardage Guide

Yardage of Roller Awnings – 46 in. Including Ends

Sum of Ht. and Projection	Width of Awning																Deduct for Each End Not Req'd.	
	8	10	12	14	16	18	20	22	24	26	28	30	32	34	36	38		40
6-0	11	11	14	14	17	17	19	19	22	22	25	25	27	27	30	30	33	1 1/2
7-0	12	12	15	15	18	18	21	21	24	24	27	27	30	30	33	33	36	1 1/2
8-0	13	13	16	16	19	19	22	22	25	25	28	28	31	31	34	34	37	2
9-0	16	16	20	20	23	23	26	26	30	30	33	33	36	36	40	40	43	3
10-0	18	18	21	21	25	25	28	28	32	32	35	35	39	39	42	42	46	3 1/2
11-0	19	19	22	22	26	26	30	30	33	33	37	37	41	41	44	44	48	3 1/2
12-0	20	20	24	24	28	28	32	32	36	36	40	40	44	44	48	48	52	4
13-0	22	22	26	26	30	30	34	34	39	39	43	43	47	47	51	51	56	4 1/2
14-0	23	23	27	27	31	31	36	36	40	40	44	44	49	49	53	53	57	4 1/2
15-0	24	24	29	29	34	34	38	38	43	43	48	48	52	52	57	57	62	5
16-0	26	26	30	30	35	35	40	40	45	45	50	50	55	55	60	60	65	5 1/2

Cutting Table

Cutting Table

A reference for determining the required number of widths of material in a given length. (1 in. seam allowance per width included)

Number of Widths	31"	36"	46"	48"	62"
1	2' 6 1/2"	2' 11"	3' 9"	3' 11"	5' 1"
2	5' 1"	5' 10"	7' 6"	7' 10"	10' 2"
3	7' 7 1/2"	8' 9"	11' 3"	11' 9"	15' 3"
4	10' 2"	11' 8"	15' 0"	15' 8"	20' 4"
5	12' 8 1/2"	14' 7"	18' 9"	19' 7"	25' 5"
6	15' 3"	17' 6"	22' 6"	23' 6"	30' 6"
7	17' 9 1/2"	20' 5"	26' 3"	27' 5"	35' 7"
8	20' 4"	23' 4"	30' 0"	31' 4"	40' 8"
9	22' 10 1/2"	26' 3"	33' 9"	35' 3"	45' 9"
10	25' 5"	29' 2"	37' 6"	39' 2"	50' 10"
11	27' 11 1/2"	32' 1"	41' 3"	43' 1"	55' 11"
12	30' 6"	35' 0"	45' 0"	47' 0"	61' 0"
13	33' 1/2"	37' 11"	48' 9"	50' 11"	66' 1"
14	35' 7"	40' 10"	52' 6"	54' 10"	71' 2"
15	38' 2 1/2"	43' 9"	56' 3"	58' 9"	76' 3"
16	40' 8"	46' 8"	60' 0"	62' 8"	81' 4"
17	43' 2 1/2"	49' 7"	63' 9"	66' 7"	86' 5"
18	45' 9"	52' 6"	67' 6"	70' 6"	91' 6"
19	48' 3 1/2"	55' 5"	71' 3"	74' 5"	96' 7"
20	50' 10"	58' 4"	75' 0"	78' 4"	101' 8"
21	53' 4 1/2"	61' 3"	78' 9"	82' 3"	106' 9"
22	55' 11"	64' 2"	82' 6"	86' 2"	111' 10"
23	58' 11 1/2"	67' 1"	86' 3"	90' 1"	116' 11"
24	61' 0"	70' 0"	90' 0"	94' 0"	122' 0"
25	63' 6 1/2"	72' 11"	93' 9"	97' 11"	127' 1"
26	66' 1"	75' 10"	97' 6"	101' 10"	132' 2"
27	68' 7 1/2"	78' 9"	101' 3"	105' 9"	137' 3"
28	71' 2"	81' 8"	105' 0"	109' 8"	142' 4"
29	73' 8 1/2"	84' 7"	108' 9"	113' 7"	147' 5"
30	76' 3"	87' 6"	112' 6"	117' 6"	152' 6"
31	78' 9 1/2"	90' 5"	116' 3"	121' 5"	157' 7"
32	81' 4"	93' 4"	120' 0"	125' 4"	162' 8"
33	83' 10 1/2"	96' 3"	123' 9"	129' 3"	167' 9"
34	86' 5"	99' 2"	127' 6"	133' 2"	172' 10"
35	88' 11 1/2"	102' 1"	131' 3"	137' 1"	177' 11"
36	91' 6"	105' 0"	135' 0"	141' 0"	183' 0"
37	94' 1/2"	107' 11"	138' 9"	144' 11"	188' 1"
38	97' 6"	110' 10"	142' 6"	148' 10"	193' 2"
39	99' 1 1/2"	113' 9"	143' 3"	152' 9"	198' 3"
40	101' 8"	116' 8"	150' 0"	156' 8"	203' 4"

Numerical

210® Plastic Cleaner And Polish	154
210® Plus Plastic Scratch Remover	154
303® Aerospace Protectant™	154
303® Fabric Guard™	154
303® Multi-Surface Cleaner™	154
303® Spot Cleaner	154

A

ACW Cam Buckles	201
ACW Side Release Buckles	200
Amerglo™	93
Anchor – Pool Cover	240
APCO Apseal™	156
APCO FabClean™ Green	155
APCO TentClean™ Green	155
APCO VinylClean Plus™	155
APCO Vinyl Protector	155
Aqualon® Edge	53
Aqualon® Edge Binding	282
Aqualon® Edge Warranty	106
Aqua-Tite® II Green SPG	155
Arabian™ Dyed Army Duck	99
Architec 400®	90
Architec 400® Warranty	106
Architent®	104
Architent WideSide®	104
Awl – Automatic	259
Awl – Heavy-Duty Scratch No. 4	259
Awning Composer®	30
Awning Hardware – Bracket Hinge	171
Awning Hardware – Bracket Hinge – Aluminum	169
Awning Hardware – Camelback Hinge – Zinc Die-Cast	171
Awning Hardware – Elbow	165
Awning Hardware – Extra Projection Hinge	172
Awning Hardware – Eye End – Aluminum	167
Awning Hardware – Eye End – Malleable Iron	167
Awning Hardware – Front Bar Clamp – Aluminum	167
Awning Hardware – Head Rod Clamp – For Brick Or Stone – Aluminum	168
Awning Hardware – Head Rod Clamp – For Narrow Base Installation – Aluminum	168
Awning Hardware – Head Rod Clamp – For Wood – Aluminum	168
Awning Hardware – Head Rod Clamp – Narrow Base Type – Zinc Die Cast	168
Awning Hardware – Head Rod Clamp – Roller Curtain Type – Malleable Iron	168
Awning Hardware – Head Rod Clamp – Zinc Die Cast	168
Awning Hardware – Hinge Silencer Spring	172
Awning Hardware – Hinge – Stamped Steel	172
Awning Hardware – Jaw End With Lag Screw	172
Awning Hardware – Pin Or Nut End	166
Awning Hardware – Pipe Clamp – Wrought Steel	171
Awning Hardware – Pulley – Malleable Iron	169
Awning Hardware – Rod And Rafter Holder No. 4	168
Awning Hardware – Rod And Rafter Holders – Dual Duty – Aluminum	169
Awning Hardware – Rod And Rafter Holders – For Brick Or Wood – Aluminum	169
Awning Hardware – Round Head Machine Screw	171
Awning Hardware – Slip-Fit Adjustable Front Bar	167

Awning Hardware – Slip-Fit Adjustable Post Socket – For Brick – Aluminum	170
Awning Hardware – Slip-Fit Adjustable Post Socket – For Brick – Malleable Iron	170
Awning Hardware – Slip-Fit Adjustable Post Socket – For Wood – Malleable Iron	170
Awning Hardware – Slip-Fit Coupling	170
Awning Hardware – Slip-Fit Elbow	166
Awning Hardware – Slip-Fit Eye End	167
Awning Hardware – Slip-Fit Eye End – Aluminum	167
Awning Hardware – Slip-Fit Rafter And Upright Tees	171
Awning Hardware – Slip-Fit Square Elbow	166
Awning Hardware – Slip-Fit Tee	170
Awning Hardware – Slip-Fit Tie-Down Clamp	169
Awning Hardware – Slip-Fit Tie-Down Clamp – Aluminum	169
Awning Hardware – Spear Head	171
Awning Hardware – Spear Head – Aluminum	171
Awning Hardware – Swivel Eye Pulley – Aluminum Die Cast	169
Awning Hardware – Swivel Eye Pulley – Stamped	169
AwnTex® 70	70
AwnTex® 70, 120 and 160 Warranty	106
AwnTex® 120	70
AwnTex® 160	71

B

Backing – Cut-Away	275
Backing – Tear-Away	275
Bendarc Quick-Switch Bender	270
BetterVue™	101
Bimini Bow Frames	219
Binder	259
Binding – Vinyl – 300 Series	284
Binding – Vinyl – Imperial	284
Block-It® Matrix	93
Boat Top Fittings – Aluminum – Boat Cover Socket	217
Boat Top Fittings – Aluminum – Deck Mounting Hinge	218
Boat Top Fittings – Aluminum – Insert Eye End	218
Boat Top Fittings – Aluminum – Jaw Slide	218
Boat Top Fittings – Aluminum – Pontoon Deck Hinge	218
Boat Top Fittings – Aluminum – Pontoon H Bracket	218
Boat Top Fittings – Aluminum – Pontoon Jaw Slide	218
Boat Top Fittings – Aluminum – Slip Fit Eye End	218
Boat Top Fittings – Aluminum – Tower Clamp	218
Boat Top Fittings – Chrome-Plated Zinc Die-Cast – Angle Hinge	220
Boat Top Fittings – Chrome-Plated Zinc Die-Cast – Boat Cover Socket	220
Boat Top Fittings – Chrome-Plated Zinc Die-Cast – Coaming Side Plate	219
Boat Top Fittings – Chrome-Plated Zinc Die-Cast – Deck Hinge	220
Boat Top Fittings – Chrome-Plated Zinc Die-Cast – Deck Mounting Hinge	220
Boat Top Fittings – Chrome-Plated Zinc Die-Cast – Eye Strap	220
Boat Top Fittings – Chrome-Plated Zinc Die-Cast – Insert Eye End	219
Boat Top Fittings – Chrome-Plated Zinc Die-Cast – Jaw Slide	220
Boat Top Fittings – Chrome-Plated Zinc Die-Cast – Slip Fit Eye End	220
Boat Top Fittings – Nickel-Plated Brass – Adjuster Buckle	220
Boat Top Fittings – Nickel-Plated Brass – Eye Strap	220
Boat Top Fittings – Nickel-Plated Brass – Solid Eye Snap Hook	221
Boat Top Fittings – Nylon – Bimini Top Ladder Clip	221
Boat Top Fittings – Nylon – Bow Socket	222
Boat Top Fittings – Nylon – Curved Shim	222
Boat Top Fittings – Nylon – Double Wing Windshield Latch	222

Boat Top Fittings – Nylon – Eye End 221

Boat Top Fittings – Nylon – Eye Strap 222

Boat Top Fittings – Nylon – Gasket 222

Boat Top Fittings – Nylon – Hinge 222

Boat Top Fittings – Nylon – Jaw Slide 222

Boat Top Fittings – Nylon – Lashing Hook 222

Boat Top Fittings – Nylon – Mounting Plate 223

Boat Top Fittings – Nylon – Rigid Support Clip 221

Boat Top Fittings – Nylon – Side Curtain Spacer 223

Boat Top Fittings – Nylon – Vadney Clip 221

Boat Top Fittings – Nylon – Wedge 223

Boat Top Fittings – Stainless Steel – Bolster Clip 233

Boat Top Fittings – Stainless Steel – Push Button 233

Boat Top Fittings – Stainless Steel Type 304 – Adjuster Buckle 225

Boat Top Fittings – Stainless Steel Type 304 – Dee Ring 225

Boat Top Fittings – Stainless Steel Type 304 – Hinge/Set Screw 225

Boat Top Fittings – Stainless Steel Type 304 – Lift Ring 225

Boat Top Fittings – Stainless Steel Type 304 – Pull Pin 225

Boat Top Fittings – Stainless Steel Type 304 – Snap Hook 226

Boat Top Fittings – Stainless Steel Type 316 – Adjuster Buckle 232

Boat Top Fittings – Stainless Steel Type 316 – Angle Hinge 228

Boat Top Fittings – Stainless Steel Type 316 – Ball Eye End 226

Boat Top Fittings – Stainless Steel Type 316 – Concave Hinge 228

Boat Top Fittings – Stainless Steel Type 316 – Counter Bore Eye End 226

Boat Top Fittings – Stainless Steel Type 316 – Deck Hinge 229

Boat Top Fittings – Stainless Steel Type 316 – Double-Sided Jaw Slide 230

Boat Top Fittings – Stainless Steel Type 316 – Elbow Eye End 233

Boat Top Fittings – Stainless Steel Type 316 – Eye End 226

Boat Top Fittings – Stainless Steel Type 316 – Eye Strap 227

Boat Top Fittings – Stainless Steel Type 316 – Grab Handles 227

Boat Top Fittings – Stainless Steel Type 316 – Heavy-Duty Jaw Slide 231

Boat Top Fittings – Stainless Steel Type 316 – Hinged Jaw Slide 230

Boat Top Fittings – Stainless Steel Type 316 – Hinged Tee 233

Boat Top Fittings – Stainless Steel Type 316 – Hinge/Set Screw 228

Boat Top Fittings – Stainless Steel Type 316 – Humpback Eye End 227

Boat Top Fittings – Stainless Steel Type 316 – Humpback Jaw Slide 231

Boat Top Fittings – Stainless Steel Type 316 – Insert Eye End 227

Boat Top Fittings – Stainless Steel Type 316 – Jaw Slide 231

Boat Top Fittings – Stainless Steel Type 316 – Jaw Slide For Pop Rivet 231

Boat Top Fittings – Stainless Steel Type 316 – Lashing Hook 230

Boat Top Fittings – Stainless Steel Type 316 – Locking Rail Hinge 229

Boat Top Fittings – Stainless Steel Type 316 – Plug 233

Boat Top Fittings – Stainless Steel Type 316 – Post 229

Boat Top Fittings – Stainless Steel Type 316 – Pull Pin 232

Boat Top Fittings – Stainless Steel Type 316 – Push Button 232

Boat Top Fittings – Stainless Steel Type 316 – Quick Release Pin 232

Boat Top Fittings – Stainless Steel Type 316 – Rail 230

Boat Top Fittings – Stainless Steel Type 316 – Side Deck Plate Hinge 229

Boat Top Fittings – Stainless Steel Type 316 – Side Mount Hinge 230

Boat Top Fittings – Stainless Steel Type 316 – Side Mount with Concave Base 232

Boat Top Fittings – Stainless Steel Type 316 – Slip Tee 233

Boat Top Fittings – Stainless Steel Type 316 – Snap Hook 232

Boat Top Fittings – Stainless Steel Type 316 – Socket 228

Boat Top Fittings – Stainless Steel Type 316 – Socket Jaw Slide 231

Boat Vent 3 237

Boat Vent Circle Cutter 237

Boat Vent II 237

Bobbins – A&E Poly Nu Bond™ Polyester 298

Bobbins – Aqua-Seal™ 296

Bobbins – Coats Dabond® Belbobs® 298

Bobbins – Coats Dual Duty® 296

Bobbins – Coats Polymatic® Belbobs® Bonded Monocord Dacron® 297

Bobbins – Coats Ultra Dee® Polyester 297

Bobbins – Premofast™ 298

Bobbins – SunStop® 298

Bow Slats – Fiberglass 219

Bracket – Joining 181

Bracket – L 181

Bracket – Z 181

Braid – Nylon/Polyester Elastic 304

Braid – Polyester 279

Buckles – For Nylon Or Polyester Webbing 198

Buckles – “Push-Button” 198

Buckles – Single Bar 198

Buckles – Tongueless 198

Bullion Fringe – Blended Polyester 277

C

Calabaña® 26

Calabaña® Warranty 107

California Oxford Cloth 69

Canton Flannel Natural – Untreated 100

Canvak 158

Canvex® 68

Care and Cleaning General Instructions for Selected Fabrics 105

Chain – Double Loop Steel 179

Chair Duck 99

Clearco 444 152

Clear Double-Polished Vinyl Rolls 60

Clear Double-Polished Vinyl Rolls – Flame Retardant 60

Clear Vinyl Extruded 61

Cleat – Awning 179

Clip And Dee – Nickel Plated 198

Clip And Dee – Stainless 199

Commercial 95@ 340 91

Commercial 95@ 340 Warranty 108

Commercial FR 300 (SaFRshade™) 92

Commercial FR 300 (SaFRshade™) Warranty 107

Comtex® 90

Comtex® Warranty 109

Cooley-Brite® 28

Cooley-Brite® / Cooley-Brite® Lite Warranty 110

Cooley-Brite® II with Coolthane® EPS 28

Cooley-Brite® II with Coolthane® EPS Warranty 110

Cooley-Brite® Lite 29

Cool Glo™ / Northstar® 27

Cool Glo™ / Northstar® Warranty 109

Cord – Cone Spring Hooks 316

Cord – Corsair Diamond Braid Polyester 310

Cord – Cotton Lacing 310

Cord – Crown Cotton 310

Cord – Diamond Braided MFP 311

Cord – Diamond Braided Nylon 310

Cord – Diamond Braided Nylon Utility311
 Cord – Drawtite Cotton311
 Cord – Hog Ring Pliers317
 Cord – Hollow Braided Polypropylene311
 Cord – Loop And End Clamps317
 Cord – MFP Solid Braided Polypropylene311
 Cord – Neobraid® Polyester312
 Cord – Neoline® Polyester313
 Cord – Nylon314
 Cord – Nylon Shock315
 Cord – Plier Clamp317
 Cord – Premium Sash310
 Cord – Saxon Nylon314
 Cord – Single Cover Elastic315
 Cord – Solid Braided Nylon314
 Cord – Solid Braided Polyester313
 Cord – Synthetic Shock316
 Cord – Twisted S.F.T. Polypropylene314
 Cord – Venetian Blind310
 Coverlight® CSM Coated Nylon94
 Coverlight® Neoprene® Coated Nylon95
 Crocodile Hanger®234
 Crownarc Crown Bender271
 Crystal Clear 20/2061
 Curtain Loop – Shower/Bath179
 Cutter – Side Cutter268
 Cutter – Special Cutter268
 Cutter – Tubing268
 Cutting Pad270

D

Dacron® Sailcloth and Cover Cloth59
 Dacron® Tape59
 DecoFlex WireFree™ RTS144
 Dee Ring – Non-Welded – Zinc Plated199
 Dee Ring – Welded – Zinc Plated199
 Dickson North American Collection – Solids16
 Dickson North American Collection – Stripes17
 Dickson® North American Collection Warranty111
 Disc And Prong180
 Dock Seal95
 DOT® Baby Durable™204
 DOT® Common Sense® / Curtain Fasteners205
 DOT® Durable™207
 DOT® Durable™ Blind Rivet Stud206
 DOT® Durable™ Enamel206
 DOT® Durable™ Mariner™206
 DOT® Durable™ Stainless210
 DOT® Lift-The-Dot®212
 DOT® Pull-The-Dot®214
 DOT® Snapmaster M840259
 Double-Filled Pre-Shrunk Bleached Duck99
 DrillSteady Drill For Stainless Tubing259
 Duvetyne102

E

Eave Web Guy Fitting244
 Emseal UST Awning/Sign Sealant Tape183
 Energy Shield™97
 Engel Hot Knife264
 Eradicating Fluid29
 Eradi-Lite®27
 Eradi-Lite® Warranty111
 Evolution®93
 E-Z Lace Supreme®197

F

Fabric Fastener Kit262
 Fasnap® Fasteners211
 Fasnap® PM5 Grommet Machine264
 Fasnap® Rib Tree Bolster Fasteners211
 Fastex® Barreloc202
 Fastex® Cam Buckle201
 Fastex® D-Ring202
 Fastex® Ellipse Cordloc202
 Fastex® Ladderloc™201
 Fastex® Looploc202
 Fastex® Sewable Grommet202
 Fastex® Shock Cord Hook202
 Fastex® Side Release Buckle201
 Fastex® Triglide™ 3 Bar Slide202
 Firesist®18
 FIRESIST® Warranty112
 Flag – Nylon93
 Fluorescent Eggcrate Louvers180
 Footman Loop199
 Fyrguard™ Fire and Water-Resistant Cover Duck97

G

Gatorshield® – Galvanized Finish Steel Tubing192
 Gatorshield® – Touch Up Paint192
 Gatorshield® – Tubing Plug192
 GatorStitch™187
 Goldline® EPDM Tie-Down And Tarp Strap242
 Grommet – Aluminum With Plain Washer193
 Grommet – Brass Eyelet And Washer193
 Grommet – Brass Rolled Rim With Spur Washer193
 Grommet – Brass Rolled Rim With Spur Washer – Black193
 Grommet – Brass With Plain Washer194
 Grommet – Brass With Plain Washer – Black194
 Grommet – Brass With Tooth Washer195
 Grommet – Brass With Tooth Washer – Black195
 Grommet Kit – Home269
 Grommet – Nickel-Plated Brass With Plain Washer195
 Grommet – Nickel-Plated Rolled Rim Brass With Spur Washer196
 Grommet – Nickel-Plated With Tooth Washer196
 Grommet – Scovill Grommets With Washers197
 Grommet – Scovill Rolled Rim Grommets With Spur Washers197

Grommet – Self-Piercing 196
 Grommet – Self-Piercing Rolled Rim With Spur Washer 196
 Grommet – Self-Piercing With Plain Washer 196
 Grommet – Sharpened Edge With Small Tooth Locking Channel Washer 196
 Grommet – Special Brass And Washers 197
 Gudgeon – Square Hole 172

H

Hammer – Dead Blow 269
 Hammer – Rawhide Replacement Heads 270
 Hammer – Rawhide With Split Head – No. 395 269
 Hammer – Tack 270
 Hand Notcher 264
 Hand Press No. M-380E 262
 Hand Press No. M-380E – Dies For DOT® Durable™ Fasteners 262
 Hand Press No. M-380E – Dies For DOT® Lift-The-Dot® Fasteners 262
 Hand Press No. M-380E – Dies for DOT® Pull-The-Dot® Fasteners 262
 Hand Roller 271
 Hand Tools For DOT® Common Sense® Fasteners 261
 Hand Tools For DOT® Common Sense® / Lift-The-Dot® Fasteners 260
 Hand Tools For DOT® Durable™ or Glove Button Fasteners 261
 Hand Tools For DOT® Lift-The-Dot® Fasteners 261
 Hand Tools for Fasnep® Fasteners 262
 HANGTYTE Boat Cover System 238
 HAR Adhesive – 628 For Bonding Neoprene Coated Fabrics 152
 HAR Adhesive – 728 For Bonding Vinyl To Vinyl 152
 HAR Adhesive – 729 Vinyl Seam Sealer 153
 HAR Adhesive – 730 For Bonding Vinyl-Laminated Fabrics 152
 HAR Adhesive – 740 For Cotton Ducks 152
 Harbor-Time® 53
 Harbor-Time® Warranty 112
 Head Rod – Electro-Galvanized 181
 Head Rod – Fiberglass 182
 Herculite® Excel M Series™ 22
 Herculite® Excel M Series™ Warranty 112
 Herculite® Natura™ 22
 Herculite® Natura™ Warranty 112
 Herculite® No. 80M 97
 Herculite® No. 90 97
 Herculite® Riviera Marine Fabric™ 55
 Herculite® Riviera Marine Fabric™ Warranty 113
 Herculite® Translucent – Flame Retardant 97
 HH-66 Vinyl Cement 152
 HH-66 Vinyl Cement Thinner 152
 High Temperature Cloth 103
 Hole Punch 264
 Hook – Roller 179
 Hook – Tarp Binding 240
 Hook – Tarp Strap “S” 242
 Hydem Gimp 286
 Hydem Gimp – Acrylic 286

I

IMAR® #42 Detail Kit 157
 IMAR® #604 Stamoid® Marine Vinyl Care Bucket 157
 IMAR™ #301 Strataglass™ Protective Cleaner 156
 IMAR™ #302 Strataglass™ Protective Polish 156
 IMAR™ #401 Yacht Soap Concentrate 156
 IMAR™ #402 Yacht Polish 156
 IMAR™ #601 Stamoid® Marine Vinyl Protective Cream 157
 IMAR™ #602 Stamoid® Marine Vinyl Protective Spray 157
 IMAR™ #603 Stamoid® Marine Vinyl Cleaner 157
 IOSSO® E-Z Snap Lubricant 158
 IOSSO® Fabric Cleaner & Protectant Kit 158
 IOSSO® Metal Polish 158
 IOSSO® Mold And Mildew Stain Remover 157
 IOSSO® Seam Sealer 153
 IOSSO® Water Repellent 157

K

Keder – Marine 234
 Keder – Roller Track 234
 Keder – Tent 235
 Kentucky Pack Cloth 69
 Klear-To-Sea™ 158

L

Lam-A-Lite™ Style C10641 98
 Lam-A-Lite™ Style C13604 98
 Leather Pearl Splits 220
 Line – Colored Cotton Awning 310
 Line – Ultra Awning 310
 Line – Ultra Mason 310

M

Main Street® + 25
 Main Street® + Warranty 113
 Makrolon® AR2 62
 Mallet/Maul – Rawhide 269
 Michigan Cloth – Cordura® 68
 Midwest Brand Wide – # Duck 100
 Molding – Aluminum Awning 182
 Molding – Aluminum Awning – Bright Dipped 182
 Molding – Dietz Head Rod Molding 185
 Molding – Head Rod Molding No. 35/37 184
 Montana Cloth 70
 Mooring Pole – Aluminum Extension 223
 Mooring Pole – Aluminum “Thumb Screw” 223
 Mr. Clearco Food Grade Silicone Spray 159
 Multi-Duty Hand Press No. W-1 264
 Multi-Duty Hand Press No. W-1 – Dies 265

N

Nassimi Breeze Beachcomber Vinyl Upholstery 64
 Nassimi Breeze Phoenix Vinyl Upholstery 64
 Nassimi Breeze Seaquest Hydem Gimp 63, 285
 Nassimi Breeze Seaquest Roll 'N Pleat Vinyl Upholstery 63
 Nassimi Breeze Seaquest Vinyl Upholstery 62
 Nassimi Breeze Seaquest Welt 64, 286
 Nassimi Breeze Vibe Vinyl Upholstery 65
 Nassimi Breeze Vinyl Upholstery Warranty 113
 Nautolex® Capitano Marine Vinyl Upholstery, SofDura and Voyager® Warranty 114
 Nautolex® Capitano™ Channeling 66
 Nautolex® Capitano™ Hydem Gimp 286
 Nautolex® Capitano™ Hydem Gimp 66
 Nautolex® Capitano™ Marine Vinyl Upholstery 66
 Nautolex® Headliner 67
 Nautolex® Marine Flooring 68
 Nautolex® Marine Flooring Warranty 114
 Nautolex® SofDura 67
 Nautolex® SofDura Channeling 67
 Nautolex® Underlining 68
 Nautolex® Voyager® 67
 Nautolex® Voyager Channeling 67
 Needle – Sail 239
 Nico-Fab® Tarp Fabric 98
 Nite-Lite® 26
 Nite-Lite® Warranty 114
 Noah® Barrier Fabric 93
 No-See-Um Netting 101
 Nylon Pole Fittings 224
 Nylon Pole Pads 224
 Nylon Taffeta 70

O

Ohio Pack Cloth 69
 Oregon Oxford Cloth 69
 O Ring 241
 O'Sea™ Coated Press Polished Sheets 61

P

Patio 500® 20
 Patio 500® Warranty 114
 Pattern Fabric 68
 Pencil – Fabric Marking 239
 Phifer® Aluminum Screening 102
 Phifer® Fiberglass Screening 101
 Phifer® PetScreen® 102
 Phifer® Solar Insect Screening 102
 Phifertex® 45, 71
 Phifertex® Cane Wicker Collection 46
 Phifertex® General Purpose 96
 Phifertex® Jacquards 47
 Phifertex® Olefin/PVC Blend 48
 Phifertex® Plus 45, 72

Phifertex® Recreational Mesh 96
 Phifertex® Stripes 46, 72
 Phifertex® Warranty 115
 Phifer® TuffScreen® 102
 Phifer® UltraVue® 102
 Pins – T 239
 Pins – Upholstery 239
 Pliers – Fabric Pulling Pliers No. 250 265
 Pliers – VISE® Pliers Kit for DOT® Durable™ 262
 Polyester Filter Cloth 103
 Polyester Utility Mesh 96
 Polyfab™ Pro Shade Sail Cleaner 155
 Polyfab™ Pro Shade Sail Hardware 162
 Polyfab™ Shade Sail Edge Webbing 165, 299
 Poly-Mesh L60611 98
 Polypropylene Filter Fabric 103
 Polypropylene Trampoline Fabric 103
 Polytex® 91
 Polytex® Warranty 115
 Pooltex 103
 Porcelain Rings 179
 Pres-N-Snap® 263
 Pres-N-Snap® – Grommet Dies 263
 Pulley – Stamped Steel – Swivel Eye 173
 Pulley – Swivel Eye 173
 Punch Kit – Self-Centering 269

Q

Q-Snap® Fasteners 215
 Quick-Fit™ Tool Kit 264

R

Regalite® Fenestra Uncoated Press Polished Sheets 60
 Regalite® / O'Sea® Firma Press Polished Sheets 60
 Regalite® Uncoated Press Polished Sheets 60
 Regatta® Binding 283
 Regatta® Facing 285
 Renter's Choice 104
 Revolving Punch No. 155 265
 Revolving Punch No. 155 – Cutting Tube Kit 265
 Revolving Punch No. 155 – Cutting Tubes 266
 Revolving Punch No. 155 – Punch Anvil 266
 Ring Clips 179
 Ring – Dee Nickel Plated 200
 Riviera Marine Fabric™ Binding 283
 RollEase® Roller Shade System 146
 Rope – 3-Strand Polypropylene 314
 Rope – Diamond Braided Polyester 311
 Rope – Supreme MFP Braided 311
 Rope – Unmanila™ Polypropylene 315
 Rope – Yukon Braided Cotton 311
 Rope – Zenith 314

S

Sailmaker’s Palm	239	SheerWeave® 7100	83
Sateen Duck	100	SheerWeave® 7500	83
Scenery Fabrics – Non-Flame Resistant, Unbleached	103	SheerWeave® BASIC 3%	83
Screw Eye	240	SheerWeave® BASIC 5%	84
Screw Eye – Long Shank	241	SheerWeave® Exterior Warranty	120
Screw Eye – Open Eye	241	SheerWeave® Infinity 2	84
Sea Clear Polycarbonate	62	SheerWeave® Interior Warranty	120
SeaMark™	54	Shelter-Rite® Poly-R Scrim	98
SeaMark™ Warranty	116	Shelter-Rite® Tarp Fabric Style 2118	99
Sea-Sprae®	53	Shelter-Rite® Tarp Fabric Style 3022	99
Sea-Sprae® Warranty	116	Showtime® II	104
Serge Ferrari Précontraint® 502 Satin	23	Showtime® II Warranty	120
Serge Ferrari Précontraint® 502 Satin Warranty	116	Silicone-Coated Fiberglass Cloth	103
Serge Ferrari Soltis® 86	87	SIMU® Solar AutoSun™ Solar Power Operator	143
Serge Ferrari Soltis® 86 and 92 Warranty	117	Single-Filled Enameling Duck	100
Serge Ferrari Soltis® 92	88	Single-Filled Ounce Duck	100
Serge Ferrari Soltis® 92 Blackout	89	Single-Filled Ounce Duck – A-Grade	100
Serge Ferrari Soltis® B702 Black Out	89	Slide Track – Aluminum – Track	223
Serge Ferrari STAM 6002L Warranty	118	Slide Track – Nylon – Hinge	223
Setting Die For Plain And Tooth Grommets And Washers	268	Slide Track – Nylon – Slide Cap	223
Setting Die For Rolled Rim Grommets And Spur Washers	269	Slide Track – Nylon – Slide Lock	223
Sewing Kit	266	Slide Track – Nylon – Slides	223
SGS Thermal Digital Print Film	15, 93	Slip Tee	171
SGS Thermal Lettering Film	15, 93	Snap – Bolt	243
Shade Inspiration Collection™	146	Snap – Curtain Trigger	243
Shears – Ergonomic Shears	266	Snapfast® System	216
Shears – Kretzer®	267	Snaphook – Interlocking Snaphook	203
Shears – WISS® Industrial Shears	267	Snaphook – Retainer	203
Shears – WISS® Industrial Shears – Heavy Duty	267	Snaphook – Standard Snaphook	203
Shears – WISS® Shop Shears	267	Snap – Spring	243
Shears – WISS® Upholstery, Carpet And Fabric Shears	266	Snap – Tent Wall	243
Shears – WISS® Upholstery, Drapery, Carpet And Fabric Shears – Heavy Duty	266	Softouch™	94
SheerWeave® 1000	73	Softouch™ Warranty	121
SheerWeave® 2000-01	73	Solair® Accessories	135
SheerWeave® 2100-01	74	Solair® Cable And Vertical Curtain Components	138
SheerWeave® 2360	74	Solair® Cable Curtain	137
SheerWeave® 2390	75	Solair® Comfort Components	135
SheerWeave® 2390 Performance +	75	Solair® Comfort Hood Kit	135
SheerWeave® 2410	76	Solair® Comfort Retractable Awning ,	134
SheerWeave® 2410 Performance +	76	Solair® Maxi Awning Covers	139
SheerWeave® 2500	77	Solair® Maxi Components	139
SheerWeave® 2701	77	Solair® Maxi Hood Kit	139
SheerWeave® 2703	78	Solair® Maxi Window Awning	139
SheerWeave® 2705	78	Solair® Patio Screens	138
SheerWeave® 2710	78	Solair® Power Screen	136
SheerWeave® 3000	79	Solair® Pro Awning Covers	131
SheerWeave® 4000 ECO	79	Solair® Pro Components	132
SheerWeave® 4100 ECO	80	Solair® Pro Hood Kit	131
SheerWeave® 4400 ECO	80	Solair® Pro Retractable Awning	130
SheerWeave® 4500	81	Solair® Pro Touch-Up Paint	132
SheerWeave® 4550	81	Solair® Pro Valance Plus Fabric	132
SheerWeave® 4600	81	Solair® Pro Valance Plus System	132
SheerWeave® 4650	81	Solair® Touch-Up Paint	132, 135
SheerWeave® 5000	82	Solair® Vertical Curtain	137
SheerWeave® 7000	82	Solvey	275
		Somfy® Altus RTS Motor	140
		Somfy® CMO Motor	142

Somfy® Eolis Wind Sensor Kit 143

Somfy® Home Automation 149

Somfy® Infrared Heater 145

Somfy® Motor Hardware 142

Somfy® Motors and Accessories for Interior Shades 149

Somfy® Motors and Accessories for Interior Shades – R28 Motor 149

Somfy® Motors and Accessories for Interior Shades – ST30 Motor 149

Somfy® myLink™ 144

Somfy® Ondeis™ WireFree RTS Rain and Sun Sensor 143

Somfy® Operators and Operator Options 140

Somfy® Soliris Sensor 143

Somfy® Sunea RTS CMO Motor 142

Somfy® Universal RTS Receiver 144

Spring Clip – Stainless Steel 239

Spring – Pool Cover 240

Spring – Snap Link 241

Spring – Trampoline 200

STAM 6002L 24

Stamoid® Binding 283

Stamoid® Facing 285

Stamoid® Marine Fabrics – Pure 58

Stamoid® Marine Fabrics – Stamoid Heavy Cover 102 in. 56

Stamoid® Marine Fabrics – Stamoid Light 59 in. 56

Stamoid® Marine Fabrics – Stamoid Light 80 in. 56

Stamoid® Marine Fabrics – Stamoid Light 102 in. 57

Stamoid® Marine Fabrics – Stamoid Open 102 in. 57

Stamoid® Marine Fabrics – Stamoid Top 59 in. 57

Stamoid® Marine Fabrics – Stamoid Top 80 in. 58

Stamoid® Marine Fabrics – Stamoid Top 102 in. 58

Stamoid® Marine Fabrics Warranty 121

Staple Remover 267

Starfire® 26

Starfire® Warranty 121

Stayput™ Fasteners 216

Steel Stitch™ Accessories 190

Steel Stitch™ DividerStrip® 190

Steel Stitch™ FlashStrip® 190

Steel Stitch™ Systems Extrusions Aluminum 186

Steel Stitch™ ZipStrip® 188

Steel Stitch™ ZipStrip® – Firesist® Fabric 189

Steel Stitch™ ZipStrip® – Firesist® Fabric with Tenara® Thread 189

Steel Stitch™ ZipStrip® – Sunbrella® Fabric 189

Steel Stitch™ ZipStrip® – Sunbrella® Fabric with Tenara® Thread 189

Strapping – Furniture 304

Strataglass™ Vinyl Sheets 61

Suction Cup 217

Sunbrella® 2016-2017 Shift Collection 35

Sunbrella® 2016-2017 Upholstery Collection – Canvas 38

Sunbrella® 2016-2017 Upholstery Collection – Decorative 37

Sunbrella® 2016-2017 Upholstery Collection – Dupione 39

Sunbrella® 2016-2017 Upholstery Collection – Linen 40

Sunbrella® 2016-2017 Upholstery Collection – Rib 41

Sunbrella® 2016-2017 Upholstery Collection – Sailcloth 40

Sunbrella® 2016-2017 Upholstery Collection – Spectrum 41

Sunbrella® 2017-2019 Fusion Collection 32

Sunbrella® Alloy 13

Sunbrella® And Mayfield Awning Display Complete 14

Sunbrella® Awning Jacquards 13

Sunbrella® Awning/Marine Solids 46 in. 7, 48

Sunbrella® Awning/Marine Solids 60 in. 8, 50

Sunbrella® Awning/Marine Solids 80 in. 9, 51

Sunbrella® Awning Stripes 10

Sunbrella® Braid – 5/8 in. – No. 6118 279

Sunbrella® Braid – 13/16 in. – No. 681 278

Sunbrella® Braid – 13/16 in. – No. 4015 European Style 277

Sunbrella® Brush Fringe 34, 276

Sunbrella® Clarity 12

Sunbrella® Contour 89

Sunbrella® Embroidery Bobbins 275

Sunbrella® Embroidery Thread 274

Sunbrella® Facing 284

Sunbrella® Graphics System Warranty 122

Sunbrella® Heritage 42

Sunbrella® Inkjet White Warranty 123

Sunbrella® Marine Binding – Centerfold 280

Sunbrella® Marine Binding – Centerfold – Type 1810 280

Sunbrella® Marine Binding – Double-Fold Bias Cut 281

Sunbrella® Marine Binding – Double-Fold Straight Cut 282

Sunbrella® Mayfield Collection 11

Sunbrella® Plus 60 in. 51

Sunbrella® Plus 80 in. 52

Sunbrella® Rain 42

Sunbrella® Shadow 43

Sunbrella® Sheer 43

Sunbrella® Sling 44

Sunbrella® Supreme 52

Sunbrella® Twist Cord-Edge 34, 276

Sunbrella® Unity 14

Sunbrella® Warranty 122

Sunbrella® Webbing 299

Sunforger® Boat Shrunk 58

Sunforger® Boat Shrunk – Flame Retardant 58

Sunforger® Car Cover Flannel 93

Sunforger® Marine Finish Boat Shrunk 59

Sunforger® Marine Finish Boat Shrunk – Flame Retardant 59

SunScreen® 84

SunTex® 80 85

SunTex® 80 and 90 Warranty 123

SunTex® 90 85

Super Seamstick/Hi-Tack Adhesive Tape 308

Super Solar Screening 85

Super-Top™ Boat Topping 58

Super-Tuff™ 158

Support Pole – Aluminum Extension 224

Sur Last® 54

Sur Last® Binding 284

Sur Last® Warranty 123

T

Tape – Curtain Strapping 309

Tape – Double-Faced 309

Tape – Double-Faced Adhesive 309

Tape – Double-Faced Transfer 309

Tape – No. 281 Nylon 280
 Tape – No. 463 Seam 309
 Tape – Reinforcing 309
 Tape – Thermo Bonding 271
 Tape – Unbleached Cotton 304
 Tape – Vinyl Adhesive Welding 309
 Tape – Vinyl Welding 308
 Tassels – Polyester 279
 Tassels – Synthetic Wood 279
 Tear-Aid® Patch Retail Kits 153
 Tear-Aid® Roll Patches 153
 Tear Mender 153
 Tent Slide 244
 Tent Slip 244
 Tent Stake – Kinked Wire 244
 Tent Stake – Polypropylene 244
 Tent Stake – Steel 244
 TEXACRO® – Hook And Loop Tape – Adhesive Back 305
 TEXACRO® – Hook And Loop Tape – Standard Back 304
 Texas Cloth 70
 Tex-Tex® 104
 Textilene® 90 86
 Textilene® 90 and 95 Warranty 124
 Textilene® 95 86
 Thread – A&E Poly Nu Bond™ Twisted Non-Wick Polyester 292
 Thread – A&E Special 293
 Thread – A&E SunStop® 294
 Thread – Aqua-Seal™ 288
 Thread – Coats Dabond® Nano 288
 Thread – Coats Dual Duty® 289
 Thread – Coats Nymo® UVR Nylon Monocord 289
 Thread – Coats Polymatic® Bonded Monocord Dacron® 290
 Thread – Coats Polymatic® Drip Stop Bonded Monocord Dacron® 289
 Thread – Coats Ultra Dee® Polyester 291
 Thread – Gore® Tenara® (HTR Style) 296
 Thread – Gore® Tenara® (Original Style) 295
 Thread – Gore® Tenara® (TR Style) 295
 Thread Nippers 266
 Thread – Premofast™ 293
 Tie-Down – EPDM Rope Heavy Duty Black 243
 Tie-Down – EPDM Rope Standard Black 242
 Ties – Awning 240
 Ties – Cable 240
 Tip – Rubber 174, 224
 T Nut Fastener 217
 Tonneau-Tex® SP 95
 Top-Snapper® 267
 Top Stop No. 10 249
 Track – Costa Track® 235
 Track – Costa Track® End Cap 235
 Track – Flex-A-Rail 236
 Track – Headliner 236
 Track – Headliner – Tools 237
 Track – Lightweight Aluminum Track No. 6200 175
 Track – PVC 235
 Track – Steel Curtain Track System – 12 Gauge – Industrial Curtain Trolley 176
 Track – Steel Curtain Track System – 12 Gauge – Roller Track 176

Track – Steel Curtain Track System – 12 Gauge – Track Splice 176
 Track – Steel Curtain Track System – 16 Gauge – Ceiling Support Brackets 176
 Track – Steel Curtain Track System – 16 Gauge – Components 178
 Track – Steel Curtain Track System – 16 Gauge – Curved Track 177
 Track – Steel Curtain Track System – 16 Gauge – End Stops 177
 Track – Steel Curtain Track System – 16 Gauge – Industrial Curtain Trolley 177
 Track – Steel Curtain Track System – 16 Gauge – Roller Track 178
 Track – Steel Curtain Track System – 16 Gauge – Track Splice 178
 Track – Steel Curtain Track System – 16 Gauge – Wall Mount And End Mount Brackets 178
 Track – Three Channel – PVC 236
 Track – Trim Screws 236
 Trailer Awning Spring 244
 Triangle Ring 199
 Triton® 59
 Triton® Warranty 124
 Trivantage® GVC18 95
 Tru-Tarp Plus 95
 Tubing – Aluminum Square And Rectangular 185
 Tubing – Marine – Aluminum 219
 Tubing – Marine – Stainless Steel Type 304 233
 Tubing – Marine – Stainless Steel Type 316 234
 Tubing “PE” – Low-Density Polyethylene 183
 Twine – Polypro 315

U

Ultrafabrics® Brisa® Indoor/Outdoor Collection 65
 Ultrafabrics® Promessa® Indoor/Outdoor Collection 66
 Ultra Tef-Gel® 159
 U.S. Army Duck Natural 100
 Utility Trash Tarp Fabric 95

V

VCP 96
 VCP Asphalt Tarps 96
 VELCRO® Brand Hook And Loop Fasteners – Adhesive Back Nylon Tape 307
 VELCRO® Brand Hook And Loop Fasteners – Adhesive Back Polyester Tape 307
 VELCRO® Brand Hook And Loop Fasteners – Polyester VELCRO® 307
 VELCRO® Brand Hook And Loop Fasteners – Standard Back Nylon Tape 305
 VELCRO® Brand Hook And Loop Fasteners – Standard Back Polyester Tape 306
 VELCRO® Brand One-Wrap® Cable Tie Straps 308
 VELCRO® Brand One-Wrap® Cable Tie Straps – Fire Retardant 308
 VELCRO® Brand One-Wrap® Fasteners 307
 VELCRO® Brand One-Wrap® Fasteners – Flame Retardant 307
 VELCRO® Brand VELSTICK® Semi-Rigid Fasteners 308
 VELCRO® Brand VELSTRETCH® Hook And Loop Fasteners 308
 Ventilator – Airlette® 238
 Ventilator – Vent-Aire® 238
 Vent-Sol-Air™ 238
 Vinyl Clear Strip 62
 Vivitex® Poly Oxford White 92
 Vivitex® Sunbrella® Inkjet White 92
 VLP® Vinyl Liquid Patch 153

W

Washer – Screw Stud211

Weatherlyte® 24

Weatherlyte® Lite 25

Weatherlyte® Lite Warranty125

Weatherlyte® Warranty124

Webbing – 3 Bar Slide 200

Webbing – Cotton – Indo-Carbon Black – Class 3 303

Webbing – Cotton – Natural – Class 1 303

Webbing – Dacron® 300

Webbing – Heat-Sealable PVC 301

Webbing – Leader 303

Webbing Loop 199

Webbing – Nylon 300

Webbing – Polyester 301

Webbing – Polypropylene Style No. 7166/P0001 302

Webbing – Polypropylene Style No. 7390/P0002 303

Webbing – Tip For Types I And II Webbing 200

Webbing – Tip For Types I, II And III Webbing 200

Webbing – Vat-Dyed Olive Drab – Shade 7 Untreated – Class 3 304

Webblon® Coastline Plus®19

Webblon® Coastline Plus® Continental Stripes 20

Webblon® Coastline Plus® Duplex19

Webblon® Coastline Plus® Linen Back 20

Webblon® Coastline Plus® Traditional Stripes 20

Webblon® Coastline Plus® Warranty126

Webblon® Regatta® Yacht Fabric 55

Webblon® Regatta® Yacht Fabric Warranty127

Webblon® Vanguard® 21

Webblon® Vanguard® Warranty127

Welt 285

Welting – Vinyl 182

Welting – Welt Cord 285

Welt – Rubber Spray 286

Welt – Windshield 287

Winding Brace172

Windscreen 103

Windshield Clip214

Worm Gear Attachments – Combination Coupling And Hook173

Worm Gear Attachments – Universal Or Knuckle Joint173

Worm Gear Attachments – Winding Shaft Eye173

X

Xtreme Seal® 287

Xtreme Seal® Awning Seal 183, 288

Xtreme Seal® Ultra Seal 287

Xtreme Seal® V-Seal 287

Y

YKK® AQUAGUARD® 245

YKK® Fasteners 203

YKK® Pull Cord 248

YKK® SNAD® Pressure Sensitive Fasteners217

YKK® Snapcap® 248

YKK® Vislon® 5VS No. 5 Chain 246

YKK® Vislon® 5VS No. 5 Sliders – Metal 246

YKK® Vislon® 5VS No. 5 Sliders – Plastic 246

YKK® Vislon® 8VF No. 8 Sliders – Metal 246

YKK® Vislon® 8VFUV No. 8 Chain 247

YKK® Vislon® 10VF No. 10 Sliders – Metal 245

YKK® Vislon® 10VF No. 10 Sliders – Plastic 245

YKK® Vislon® 10VFUV No. 10 Chain (VF) 245

YKK® Vislon® Bottom Stops 248

YKK® Vislon® Top Stops 248

YKK® Vislon® UV VFUV No. 8 Separating Zipper Non-Locking –
Double Pull Metal Slider 250

YKK® Vislon® UV VFUV No. 10 Separating Zipper Automatic Lock 249

YKK® Vislon® VFOL105W No. 10 Separating Zipper Non-Locking –
Double Pull Metal Slider 250

YKK® Vislon® VFUL106 TA No. 10 Separating Zipper With Automatic Lock –
Short Single Pull Plastic Slider251

YKK® Vislon® VFULVOL-107 DX E No. 10 Separating Zipper With Automatic Lock –
Short Double Pull Metal Slider251

YKK® Vislon® VFUVOL-86 DA E 5/8 No. 8 Separating Zipper With Automatic Lock –
Single Pull Metal Slider 257

YKK® Vislon® VFUVOL-86 DA E No. 8 Separating Zipper With Automatic Lock –
Short Single Pull Metal Slider 254

YKK® Vislon® VFUVOL-87 DXL E No. 8 Separating Zipper With Automatic Lock –
Long Double Pull Metal Slider 255

YKK® Vislon® VFUVOL-107 DX E No. 10 Separating Zipper With Automatic Lock –
Short Double Pull Metal Slider 253

YKK® Vislon® VFUVOL107TX No. 10 Separating Zipper With Automatic Lock –
Double-Pull Plastic Slider 256

YKK® Vislon® VSOL56 No. 5 Separating Zipper With Automatic Lock –
Short Single Pull Metal Slider 257

YKK® Wheel Locks 201

YKK® Ziplon® CFOR-105 DWL No. 10 Separating Zipper Non-Locking –
Double Pull Metal Slider 258

YKK® Ziplon® CFOR-106 DA E No. 10 Separating Zipper with Automatic Lock –
Single Pull Metal Slider 258

YKK® Ziplon® Chain (CF) 248

YKK® Ziplon® Sliders – Metal 247

YKK® Zippy Cool® 259

Z

Zipper Jig 2 49

Zipper Stop Application Tool 249

Zipper – YKK® Vislon® VFUVOL-106 DA E No. 10 Separating Zipper With Automatic Lock –
Short Single Pull Metal Slider 252

Zipzap Lubricants 259

Terms of Sale

Limited Warranties

Trivantage, LLC warrants that goods sold by it shall be free from defects in material and workmanship and will conform to applicable specifications and drawings. Trivantage, LLC's liability, whether based on breach of warranty or contract, negligence in manufacture, or otherwise shall be limited to replacement or repair (at Trivantage, LLC's election) of the defective or nonconforming goods, or (at Trivantage, LLC's election) refund of the purchase price thereof. This warranty shall apply, and Trivantage, LLC shall be liable for replacement, repair or refund, only if Buyer has given Trivantage, LLC written notice of the defect or nonconformity within 180 days after delivery of such goods to Buyer. Trivantage, LLC assumes no liability for results of the use of goods purchased from Trivantage, LLC, including, without limitation, their use in combination with other components, assemblies or products, or their suitability or unsuitability for a particular use or a particular environment. Trivantage, LLC makes no warranty of merchantability as to goods designated as seconds, goods otherwise designated as not of first quality, or goods identified to Buyer as being of foreign origin. Unless specifically indicated to the contrary, goods sold are not fire retardant and should not be exposed to intense heat or flame. Unless specifically indicated to the contrary, goods sold are not water resistant or waterproof. Trivantage, LLC neither undertakes to independently test nor makes any representation or warranty with respect to any manufacturer's claims for performance for its products, including the claims of a manufacturer that its product is fire retardant, water resistant or waterproof. Any warranty given by any other manufacturer or supplier of goods sold or of component parts thereof is assigned by Trivantage, LLC to the Buyer to the extent permissible under law and the terms of such warranty. **THE FOREGOING CONSTITUTES THE SOLE AND EXCLUSIVE WARRANTY OF TRIVANTAGE, LLC AND THE SOLE AND EXCLUSIVE REMEDY OF THE BUYER, AND IS IN LIEU OF ALL OTHER WARRANTIES, EXPRESS OR IMPLIED, AS TO MERCHANTABILITY, FITNESS FOR THE PURPOSE SOLD, DESCRIPTION, QUALITY OR ANY OTHER MATTER. WITHOUT LIMITING THE FOREGOING, TRIVANTAGE, LLC SHALL IN NO EVENT BE LIABLE FOR LOSS OF USE OR PROFIT, OR FOR OTHER COLLATERAL, INCIDENTAL, PUNITIVE, SPECIAL OR CONSEQUENTIAL DAMAGES.**

Orders - Acceptance, Modification and Cancellation

All orders are subject to acceptance at Trivantage, LLC's executive offices or a sales office of Trivantage, LLC, and when so accepted shall constitute a contract that will be governed by and construed in accordance with the laws of the State of North Carolina. All orders are accepted subject to these Terms of Sale and subject to approval by Trivantage, LLC of the Buyer's credit at the time of shipment. Trivantage, LLC's acceptance of an order is conditioned upon the waiver by Buyer of any terms and conditions which differ from, vary from, or add to, these Terms of Sale, which shall constitute the entire agreement of the parties as to the subject matter hereof. The specifications applicable to goods sold by Trivantage, LLC shall be Trivantage, LLC's specifications, unless Buyer shall have furnished different specifications and Trivantage, LLC shall have agreed in writing to such specifications. Trivantage, LLC reserves the right to make changes or substitutions in the items ordered without the prior approval of or notification to the Buyer, as long as such changes do not adversely affect form, fit or function requirements. Orders may not be altered or modified by the Buyer except with the written consent of Trivantage, LLC. Trivantage, LLC, at its option, may cancel all or the remaining unfilled portion of any blanket or continuing order if (a) Buyer's payments are in default; (b) Buyer breaches any material provision of Trivantage, LLC's Terms of Sale; (c) substantial changes in materials or supplies occur; (d) causes beyond Trivantage, LLC's control make it impossible to ensure shipment; (e) Buyer becomes insolvent or is subject to a petition in bankruptcy; or (f) Trivantage, LLC withdraws its credit approval. The Buyer may cancel the remaining unfilled portion of any blanket or continuing order upon written notice to Trivantage, LLC and payment of reasonable cancellation charges, which charges shall take into account goods already produced or in process, expenses incurred by Trivantage, LLC in connection with the order, and commitments made by Trivantage, LLC, as a consequence of the order; provided, however, that the cancellation charges shall not exceed the purchase price of the cancelled portion of the order.

Price and Terms

ALL QUOTED PRICES ARE BASED ON THE CURRENT NET WHOLESALE PRICES IN U.S. FUNDS PREVAILING AT THE TIME OF QUOTATION. ALL PRICES ARE SUBJECT TO CHANGE WITHOUT NOTICE AND THE PRICE CHARGED WILL BE THAT IN EFFECT AT THE TIME OF SHIPMENT. The minimum order charge may apply. The catalog indicates standard units of packaging.

Unless otherwise agreed in writing, terms are net thirty (30) days, F.O.B. shipping point, subject to approval by the Trivantage, LLC credit department. Customers without established credit approval from Trivantage, LLC should remit payment with the order, or instruct Trivantage, LLC to ship C.O.D. A service charge of 1-1/2% per month (18% per annum) or the maximum amount allowed by applicable law will be added to all past due invoices. Buyer is responsible for payment of all applicable sales, use or other taxes, whether local, state or federal, with respect to the goods purchased, or returning to Trivantage, LLC the properly completed and signed sales tax exemption form. Buyer is responsible for any import or export charges.

Shipping, Delivery and Return

Trivantage, LLC shall not be liable for delays in production or delivery due to causes beyond its control, including but not limited to acts of God, acts of Buyer, acts of civil or military authorities, priorities, fires, strikes, floods, epidemics, quarantines, war, delays in transportation and inability due to causes beyond Trivantage, LLC's control to obtain necessary labor, materials or manufacturing facilities. A shipping date given by Trivantage, LLC is an estimated date. In no event shall Trivantage, LLC be liable to the Buyer for loss of use or profit or any other collateral, incidental, punitive, special or consequential damages resulting from delays in production or delivery, whether or not due to causes beyond Trivantage, LLC's control.

Trivantage, LLC will use its best judgment in packaging, packing, shipping and routing unless Buyer gives specific instructions with its order. In the event of shortage or damage incurred enroute, Buyer must make its complaint to the delivering transportation agency and file a claim against such agency. In the event of a shortage in packing, any claim against Trivantage, LLC must be made in writing within ten (10) days of receipt of the merchandise. All shipments are made F.O.B. shipping point, unless otherwise agreed to in writing by Trivantage, LLC. Trivantage, LLC's responsibility for delivery ends with a signed bill of lading from the carrier. All risk of loss after Trivantage, LLC's delivery to the carrier shall be borne by the Buyer.

Authorization must be obtained from Trivantage, LLC prior to return of any goods for repair, replacement, or credit. Trivantage, LLC shall have the right, prior to return, to inspect any goods claimed to be defective or nonconforming. All returned shipments authorized by Trivantage, LLC shall be prepaid by Buyer. Unless Trivantage, LLC determines, upon inspection of returned goods, that the goods were defective or nonconforming, a \$15.00 or 15% handling charge (whichever is greater) will be imposed on the Buyer. No claims on fabric will be allowed, whether the goods are conforming or not, if the goods have been cut. If a pattern or color match is desired, a swatch of the pattern or color required must be submitted with the order. In no event shall Buyer be entitled to any right of set-off against Trivantage, LLC.

Miscellaneous

If any goods or services ordered by Buyer are supplied by Trivantage, LLC in accordance with designs or specifications of the Buyer, and such goods are not Trivantage, LLC's standard items or supplied in accordance with Trivantage, LLC's standard processes, Buyer shall indemnify Trivantage, LLC from any expense, loss, damage or liability which may be incurred by Trivantage, LLC on account of any infringement or alleged infringement of any U.S. or foreign patent rights with respect to such goods or processes. The sale of goods by Trivantage, LLC does not convey a license, express or implied, under any patent in which Trivantage, LLC has an interest, nor does it convey rights to any descriptive data, including Trivantage, LLC's manufacturing drawings, processes or tooling.

THE PARTIES AGREE THAT THIS AGREEMENT, ANY SALES THERE UNDER, OR ANY CLAIM, DISPUTE OR CONTROVERSY (WHETHER IN CONTRACT, TORT, OR OTHERWISE, WHETHER PREEXISTING, PRESENT OR FUTURE, AND INCLUDING STATUTORY, COMMON LAW, AND EQUITABLE CLAIMS) BETWEEN TRIVANTAGE, LLC AND BUYER arising from or relating to this agreement, its interpretation, or the breach, termination or validity thereof, the relationships which result from this agreement, or any related purchase SHALL, TO THE MAXIMUM EXTENT PERMITTED BY APPLICABLE LAW, BE GOVERNED BY THE LAWS OF THE STATE OF NORTH CAROLINA, WITHOUT REGARD TO CONFLICTS OF LAWS RULES.

Buyer irrevocably submits to the exclusive jurisdiction of the state and federal courts of the State of North Carolina for the resolution of any legal action arising out of this Agreement and irrevocably agrees that venue for such legal action shall lie exclusively in Alamance County, North Carolina, for any state court action, or in the Middle District of North Carolina for any action instituted within the federal court system.

Any provision hereunder that is prohibited or unenforceable in any jurisdiction shall, as to such jurisdiction, be ineffective to the extent of such prohibition or unenforceability without invalidating the remaining provisions hereof, and any such prohibition or unenforceability in any jurisdiction shall not invalidate or render unenforceable such provision in any other jurisdiction.

If the goods purchased are to be used in fulfilling a contract or a subcontract either with the U.S. Government or any agency thereof, Trivantage, LLC will comply with all mandatory provisions of the Government applicable to Trivantage, LLC if and only if Buyer gives Trivantage, LLC written notice of such provisions in sufficient time to permit compliance. In addition, Trivantage, LLC may, at its option, adopt any provisions of the Armed Services Procurement Regulations or other federal laws or regulations applicable to or made available to subcontractors in the prime contract.

Credit Application

Trivantage®, LLC 1831 North Park Avenue, Glen Raven, NC 27217 Phone (336) 227-6211

Company's Legal Name _____ Trade Name, If Different _____

Mailing Address _____

City _____ State _____ Zip Code _____

Phone No. _____ Fax No. _____

Federal ID No. _____ D&B No. _____

Shipping Address, If Different _____

City _____ State _____ Zip Code _____

Nature of Business _____ Yrs. in Business _____ No. of Employees _____

Annual Sales \$ _____ Sales Tax Taxable Exempt (If exempt, please attach your sales tax exemption certificate.)

Do You Own Building Rent/Lease Landlord _____ Phone No. _____

Type of Account Requested

Credit Card C.O.D./Certified C.O.D./Check Net 30 Days Line of Credit Desired \$ _____

Principal Owners/Officers (Please furnish complete addresses.)

Name	Title	Home Address	Home Phone No.
1. _____	_____	_____	_____
2. _____	_____	_____	_____
3. _____	_____	_____	_____
4. _____	_____	_____	_____

Commercial Credit References (Please furnish complete addresses.)

Business Name	Contact	City/St	Phone No.	Fax No.
1. _____	_____	_____	_____	_____
2. _____	_____	_____	_____	_____
3. _____	_____	_____	_____	_____
4. _____	_____	_____	_____	_____

Bank Reference

Name of Bank _____ Phone No. _____ Fax No. _____

Address _____

City _____ State _____ Zip Code _____

Account Manager _____ Loan Account No. _____

Checking Account No. _____ Savings Account No. _____

General Provisions

This application and the information herein is a request for the extension of credit for commercial business use only and applicant certifies that the firm he or she represents is doing business as a Corporation, LLC, Partnership, or Sole Proprietorship (check one). The applicant authorizes the above named creditor to obtain a written or oral credit report from any credit reporting agency. The applicant further authorizes any bank or commercial business with whom the applicant is doing or has done any type of business to give any and all necessary information to the creditor which will assist the creditor in the credit investigation. The applicant further authorizes the creditor to reinvestigate the applicant's credit status from time to time as the creditor deems necessary, and should creditor, upon such reinvestigation, deem it necessary, to limit or terminate the credit arrangement with said applicant.

Upon credit approval, terms are Net 30 days. Applicant agrees to pay any and all finance charges assessed at the rate of 1-1/2% per month (18% per annum, or such other amount permitted by applicable law), for late payment of any invoice. Applicant agrees to pay for all collection and/or attorney fees, related costs and subsequent interest charges for any balance placed for collection. Applicant further agrees to the creditor's Terms of Sale, a copy of which was included with this credit application. Should applicant, at some future time, deviate from the creditor's terms, said creditor reserves the right to terminate future extension of credit to applicant. If applicant's account should become delinquent or exceed the established credit limit set by creditor, orders are subject to being shipped C.O.D. or held until payment is received by creditor to bring applicant's account to a current status. If there is any change in the status of the applicant (name, address, principals, tax number, etc.), notification in writing must be made to the creditor and a new credit application may have to be completed.

Company Name _____

Owner/Officer Signature _____

Title _____

Date _____

Personal Guarantee

I, _____, residing at _____,

_____, in order to induce Trivantage, LLC ("Trivantage"), of Glen Raven, NC, to extend credit

to _____ (Name of Guarantor)

_____ (the "Company") hereby guarantee to Trivantage the prompt payment, when due, of every claim

of Trivantage which presently exists or which may hereafter arise in favor of Trivantage against the Company. This is a continuing guaranty and shall remain in force until

revoked by me by notice in writing to Trivantage, but such revocation shall be effective only as to claims of Trivantage which arise out of transactions entered into after its receipt of such notice. This obligation shall cover the renewal of any claims guaranteed by this instrument or extensions of time of payment thereof, and shall not be affected by any surrender or release by Trivantage (in whole or in part) of any claim or of other security held by it for any claim guaranteed. In the event of default of the Company in making payment on any claims of Trivantage when due, I agree, without Trivantage first having to proceed against the Company, to pay on demand all sums due and to become due to Trivantage from the Company, and all losses, costs, attorney's fees, or expenses which Trivantage might suffer by reason of the Company's default.

In witness whereof I have signed on _____ 20_____, _____

(Date)

(Signature of Guarantor)

(Signature of Witness #1)

(Signature of Witness #2)

In order to process this credit application, all information must be completed. Please allow two weeks for the processing of your application. Return to your local Trivantage Distribution Center listed below.

City of Industry, CA · Fax: 888-804-9751
Miami, FL · Fax: 800-735-6770
Missouri · Fax: 800-659-1937
Ohio · Fax: 800-473-5034

Hayward, CA · Fax: 800-767-9398
Georgia · Fax: 800-743-3469
New Jersey · Fax: 800-488-4968
Texas · Fax: 800-829-3797

Colorado · Fax: 800-895-2719
Illinois · Fax: 800-776-9483
North Carolina · Fax: 888-867-1337
Washington · Fax: 253-398-3640

FOR TRIVANTAGE USE ONLY

Credit Approved: Yes No Approval _____ Date Approved _____

Type of Credit Approved: C.O.D./Cash C.O.D./Check Net 30 Days Credit Line \$ _____

CORPORATE OFFICE

1831 North Park Avenue
Glen Raven, NC 27217-1100
(800) 786-1876
www.trivantage.com

DISTRIBUTION CENTERS

UNITED STATES

Hayward, CA (800) 786-7607
City of Industry, CA (800) 841-0555
Denver, CO (800) 786-7609
Miami, FL (800) 786-7605
Atlanta, GA (800) 786-7606
Elmhurst, IL (800) 786-7608
St. Louis, MO (800) 786-7603
Somerset, NJ (800) 786-7602
Mebane, NC (877) 540-6803
Cleveland, OH (800) 786-7601
Dallas, TX (800) 786-7610
Seattle, WA (800) 213-1465

CANADA

Trican Corp. (800) 387-2851
www.tricancorp.ca

MEXICO

Tunali Tec, Morelos (777) 362-0636
www.tunalitec.com